



2020 COMMERCIAL GROWERS CATALOG

CHEMICALS

FERTILIZER

ORGANIC PRODUCTS

GREENHOUSE SUPPLY

FARM SUPPLIES

EQUIPMENT

IRRIGATION

NEW ENGLAND | NEW YORK



JOHN DEERE
FINANCIAL

Multi-Use Account

YIELD ISN'T CALCULATED. IT'S EARNED ROW BY ROW.

Running a successful operation takes a lot of hard work. It also takes a lot more. From parts and service to seed, crop protection and feed, it all costs money. You need a single account to handle all your day-to-day and seasonal crop input purchases. Plus, you get access to exclusive money-saving finance offers and payment options designed to fit your production cycle and cash flow.

Put your **Multi-Use Account** from John Deere Financial to work with us today!

CROP INPUTS | PARTS, SERVICE & TECHNOLOGY | FARM SUPPLIES

Multi-Use Account is a service of John Deere Financial, L.P.
CR0315904

2020 GROWER CATALOG CONTENTS

CHEMICALS	5	adjuvants, insecticides, fungicides, herbicides, miticides, bait.
SAFETY	8	first aid kits, insect repellents, filters & masks, eye & ear protection, jackets & pants.
EQUIPMENT	23	sprayers, spreaders, sprinklers, hoppers, mulchers, attachments and accessories.
FARM SUPPLIES	79	traps, bait, fencing, hard tools, plastic mulch, packaging, solo sprayers, wheel barrows & more.
FERTILIZER	9	granular, liquid, soluble, soil amendments.

SOILS	78	
GREENHOUSE	36	containers & trays, growing mixes, ground cover, frames & panels, fittings, pipes and more.
IRRIGATION	76	adapters, connectors, couplings, gauges, nozzles, sprinklers.
ORGANIC PRODUCTS	13	amendments, fertilizers, supplements.
SEEDS	11	grass and turf.
MULCH COVERING	89	

Thank you for shopping Progressive Grower!

We encourage you to submit your orders two weeks before pickup or ship date, to allow us time to process and pack your order. We reserve the right to pro-rate any items in short supply. Please pickup orders no later than the month after ordering. Orders left after 30 days will be subject to available supply and price.

Upon receiving your order please inspect it immediately and report any error, shortage or damage within 3 days. Progressive Grower is not responsible for shortages reported more than 3 days after receipt.

Returns: Saleable products may be returned with permission and may be subject to handling charges based on the condition and time of return for seasonal products. Expired products, special order, and non-stock items are not returnable.

Credit Invoices: In the case of overpayments, cancellations, shortages, returns, defective products, etc. credit invoices will be issued. Credit invoices not used will be mailed annually but after 15 months will be voided.

All prices are FOB West Wareham, MA or Riverhead, NY (except items with indicated FOB point) and are subject to change without notice.

Contact us for pricing discounts on large quantity orders.

Not responsible for typos.

2020 PRE-ORDER GUIDE

Please keep in mind some items should be ordered early to insure you get them in a timely manner. Also some of these items are in short supply or can only be brought in once or twice a year. So please review the following list and consider placing your order today.

- Mulch Plastic
- Drip Tape
- Silage Sheets
- Rain Flo Equipment
- Green House Items
- Custom Fertilizer Blends
- Onions, Asparagugus, Seed Potatoes, Sweet Potato Slips

TERMS

Credit Card or check in advance.



SHIPPING OPTIONS



We also offer UPS Next Day Air and other expedited shipping options.

When Shipping LTL motor freight we compare prices among numerous carriers to find the best rates.

Progressive Grower trucks deliver in New England and New York. We will ship your order in the most economical way possible.

BioSafe Systems: FROM FIELD *to* packing

Crop Protection, Water Treatment, Organic Solutions and Post-Harvest Treatments



 **BioSafe
Systems**
Simply Sustainable. Always Effective.

1.888.273.3088 | biosafesystems.com

CHEMICALS



We will not ship product to a state where the product is not registered. Please inquire for pricing.
More products available. Please call if seeking something not listed here.

ADJUVANTS

ITEM	DESCRIPTION
12205	FOAM KILL, 1 QT.
3989	AMS MAX, 2.5 GAL
2605	FS BARRIER, 1 QT
467	FS CROPSTIK, 1 GAL
10693	FS MAXSUPREME 2.5 GAL
3606	FS MSO ULTRA, 2.5 GAL
3988	FS TALYX (PROTYX), 1 GAL
3119	FS TRANSFORM, 2.5 GAL
12056	CHEM STICK LPH, 2.5 GAL
3912	NU FILM P, 1 GAL
2974	PROGRESSIVE CROP OIL, 2.5 GAL
2604	REGULAID 2.5 GAL
3775	SORBYX, 2.5 GAL
3122	SPEED, 1 GAL
1539	SUPER SIGNAL BLUE DYE, 1 QT
1578	SUPER SIGNAL BLUE DYE, 2.5 GAL
4971	TOLERO, 2.5 GAL
4980	TRANSPORT ULTRA, 2.5 GAL

FUNGICIDES / BACTERIACIDES

ITEM	DESCRIPTION
3053	ACTIGARD 50 WG, 7.5 OZ
2790	ACTINOVATE AG, 18 OZ
12204	AFRAME, 2.5 GAL
2980	AGRIMYCIN 17, 2 LB
10743	APROVIA, 1 GAL
12168	APPROVIA TOP 1 GAL
4123	BADGE SC, 2.5 GAL / 158 GAL
12269	BLOCKER, 4F, 5 GAL
5155	BRAVO WEATHERSTICK, 2.5 GAL
5156	BRAVO ULTREX, 27.4 LB
4478	BUMPER ES, 1 GAL
2486	CABRIO EG, 5LBS
1652	CAPTAN 4L, 2.5GAL
2327	CAPTAN 80WDG, 6.25 LB / 30 LB
3678	CAPTEVATE 68 WDG, 10.5 LBS
2915	CATAMARAN, 2.5 GAL
4542	DOUBLE NICKEL LC, 2.5 GAL
2379	ELEVATE 50 WDG, 2 LB
3990	ENDURA EPA#7969-197, 6.5 LB
4930	FERBAM, 22 LB

FUNGICIDES / BACTERIACIDES (CONTINUED)

ITEM	DESCRIPTION
2332	FLINT® EXTRA, 20 OZ
2635	FONTELIS, 80 OZ
2608	FORUM, 1 GAL
2356	GAVEL 75 DF, 30 LB
5153	INDAR 2F, 1 GAL
2458	INSPIRE SUPER, 1 GAL
2612	KOCIDE 3000, 4 LB / 10 LB (Item #435)
3572	LIME SULFUR, 5 GAL / 55 GAL
10791	LUNA EXPERIENCE, 32 OZ
21-0450	LUNA SENSATION (not available on Long Island)
4843	MANKOCIDE, 30 LBS
3529	MANZATE MAX, 2.5 GAL
2380	MANZATE PROSTICK, 6 LB / 30 LB
4929	METTLE 125ME, 1 GAL or 1 QT
4496	MICRO-FINE SULFUR (90%), 30 LB
3029	MICROTHIOL DISPR, 30 LB
4119	MILSTOP, 5 LB
2485	MYCOSHIELD, 2 LB
3586	NUTROL 0-50-32
21-0050	ORONDIS OPTI, 2.5 GAL
4112	OSO 5% SC, 1 QT
497	OXIDATE 2.0, 2.5 GAL / 5 GAL / 30 GAL
10939	OXIPHOS, 1.5 GAL
3604	PH-D, 2 LB
4087	PHITICIDE, 2.5 GAL
2549	PRESIDIO, 1 QT
2404	PREVICUR FLEX, 2.5 GAL
2333	PRISTINE, 120 OZ
2701	PROCURE 480SC, 1 QT
3063	PROLINE 480 SC, 2.5 GAL
3074	QUADRIS TOP, 2.5 GAL
2449	QUINTEC, 30 OZ
2407	RALLY 40WSP, 5 X 4 OZ
4096	RANMAN, 1 GAL / 1 QT
2600	REVUS TOP, 2.5 GAL
3120	REVUS, 1 GAL
2489	RIDOMIL GOLD BRAVO, 2.5 GAL
2548	RIDOMIL GOLD MZ, 5 LB
2960	RIDOMIL GOLD SL, 1 PT / 1 GAL
10708	ROVRAL 4F 2.5 GAL
3088	SANIDATE 5.0, 5 GAL

CHEMICALS

FUNGICIDES/BACTERIACIDE (CONTINUED)

ITEM	DESCRIPTION
2632	STYLET OIL ORGANIC, 2.5 / 15 / 275 GAL
4490	SULFORIX, 2.5 GAL
2381	SWITCH 62.5WG, 28 OZ
3679	SYLLIT FL EPA#55260-6, 2.5 GAL
2490	TANOS, 7.5 LB
2351	TILT, 1 GAL
2353	TOPSIN 4.5FL, 2.5 GAL
2352	TOPSIN M WSB, 5 X 1 LB
2606	TORINO, 34 OZ
2962	VANGARD WG, 50 OZ
4979	VIVANDO SC, 1 GAL
4978	ZAMPRO EPA#7969-302, 140 OZ
10238	ZING!, 2.5 GAL
2457	ZIRAM 76DF, 10 LB / 40 LB
3047	ZEROTOL 2.0, 2.5 GAL

HERBICIDES

ITEM	DESCRIPTION
4909	ACCENT Q EPA#352-773, 18 OZ
10424	ACURON, RUP 2.5 GAL (NOT AVAIL TO SELL IN NY)
5017	AIM EC EPA#279-3241, 1 QT
2873	ALION , 32 OZ
4124	AQUANEAT, 2.5 GAL
4808	AQUASHADE, 1 GAL
2952	ATRAZINE 4L, RUP 2.5 GAL
3879	ATRAZINE 90DF, RUP 25 LBS
2644	BANVEL, 2.5 GAL
10681	BEACON (5X1.52OZ)
2536	BESIEGE, RUP 2.5 GAL
2378	BICEP II MAGNUM (NO LI SALES), RUP 2.5 GAL
4717	BROADLOOM EPS#70506-306, 2.5 GAL
5159	CALLISTO 4SC, 1 GAL
10429	CASORON CS, 2.5 GAL
463	CASORON - GRANULAR, 50 LBS
4479	CHATEAU SW, 2.5 LBS
3824	CHEETAH, 2.5 GAL
4977	CLETHODIM 2EC, 1 GAL
2373	COMMAND 3 ME, 2.5 GAL
5107	CROSSBOW, MA RUP 1 GAL / 2.5 GAL
534	CUTRINE PLUS, 1 GAL / 2.5 GAL
3914	DACTHAL FL EPA#5481-487, RUP 2.5 GAL
2849	DEVIRINOL 2XT, 2.5 GAL
2866	DEVIRINOL 50DF-XT, 4 LBS
2875	DIURON 80DF, 5 LBS
2369	DUAL II MAGNUM, MA RUP 2.5 GAL
3015	DUAL MAGNUM, MA RUP 2.5 GAL
2618	FORMULA 40, MA RUP 2.5 GAL

HERBICIDES (CONTINUED)

ITEM	DESCRIPTION
TBD	SIMAZINE DF 10 LB. / 25 LB.
TBD	DIGUAT 1 GAL / 2 1/2 GAL
2874	GALLERY 75DF, 1 LB
5100	GARLON 3A EPA 62719-37, 2.5 GAL
2374	GOAL 2XL, 2.5 GAL
2847	GOAL TENDER, 1 GAL
2488	GRAMOXONE SL 2.0, RUP 2.5 GAL
2646	IMPACT 2.8SC, 30 OZ
2642	LIBERTY 280 SL, 2.5 GAL
4921	LINEX 4L EPA#61842-21, 2.5 GAL
2484	LOROX DF, 20LBS
496	LUMAX EZ, RUP 2.5 GAL
2668	MATRIX SG, 20 OZ
4295	MEDAL II EC, MA RUP 2.5 GAL
2248/2265	BULLZEYE, 2.5 GAL / 30 GAL
10707	METRICOR, 10 LB
2968	PENDULUM AQUA CAP, 2.5 GAL
3075	PERMIT PLUS, 20 OZ
446	POAST, 2.5 GAL
4143	PRAMITOL 25, 1 GAL / 2.5 GAL
2464	PREFAR-4E, 2.5 GAL
2376	PRINCEP CALIBER 90, 10 LBS
2545	PROSEGE 2 , 1.33 OZ
2383	PROWL H2O HERBICIDE, 2.5 GAL
2645	Q4 PLUS, 2.5 GAL
474	QUINSTAR 4L, 2.5 GAL
3882	REFLEX, 2.64 GAL
2334	REGLONE, 2.5 GAL
502	ROUNDUP POWERMAX, 2.5 GAL / 30 GAL
2351	SANDEA HERBICIDE, 10 OZ
4059	SCYTHE, 2.5 GAL
5148	SELECT MAX, 2.5 GAL
4628	SIMAZINE 4L, MA RUP 2.5 GAL
2601	SINBAR 80WDG, 5LBS
2537	SOLICAM DF, 10LB
10354	SOTRION, 1 GAL
10524/3	SPEEDZONE, MA RUP 1 GAL / 2.5 GAL
5151	STINGER, 1 QT
1580	STRATEGY, 2.5 GAL
10526	SUPER TRIMEC, MA RUP 2.5GAL
2518	SURFLAN AS AG, 2.5 GAL
2460	TENACITY, 8 OZ
3268	TORDON RTU, 1 QT
2607	TRIFLUREX HFP, 2.5 GAL
10556	TRIMEC 992, 3-WAY HERBICIDE, MA RUP 2.5 GALS
3007	TRIMEC BENT GRASS, MA RUP 1 GAL
441	WEEDAR 64 BROADLEAF, MA RUP 2.5 GAL

CHEMICALS

INSECTICIDES

ITEM	DESCRIPTION
2918	ABAMECTIN 0.15EC, 1 GAL / 1 QT
3094	ACEPHATE 97UP, 1 LB / 10 LB
436	ACTARA, 30OZ
5161	ADMIRE PRO, 140 OZ
535	ALTACOR, 16OZ
2656	ASANA XL, RUP 1 GAL
3101	ASSAIL 30SG, 4LBS
2491	ASTRO, RUP 1.25 GAL
445	AVAUNT DG, RUP 18OZ
2946	BAYTHROID XL, RUP 1 GAL
4945	BELEAF 50SG, 1.5 LBS
2787	BIFENTURE EC, RUP 1 GAL
4959	BLACKHAWK, 64 OZ
2943	CAPTURE LFR, RUP 2.5 GAL
4402	CARBARYL 4L, 2.5 GAL
4643	CHLORPYRIFOS 15G, 50 LBS
2325	CONSERVE SC, T&O INSECTICIDE 1 QT
2661	CORAGEN, 1 QT / 1 GAL
4642	COUNTER 20G LNL, RUP 40LBS
2350	DAMOIL, 2.5 GAL / 55 GAL
4141	DANITOL 2.4 EC, RUP 1GAL
5154	DELEGATE WG, 26 OZ
433	DIAZINON AG500, RUP 2.5 GAL
472	DIAZINON AG600, RUP 2.5 GAL
3044	EXIREL, 2.5 GAL
10586	ESSENTRIA IC3 INSECTICIDE CONCENTRATE, 1 GAL
4524	FASTAC EC, RUP 1 GAL
3159	FULFILL, 27.5 OZ
5125	GOLDEN PEST SPRAY OIL, 1 QT / 2.5 GAL
3093	HERO, RUP 1 GAL
3636	IMIDAN 70W, 5LBS
5152	INTREPID 2F, MA RUP 1 GAL
3046	LAMBDA-CY EC-RUP, 1 GAL
2410	LANNATE LV, RUP 2.5 GAL
2448	LANNATE SP, RUP, 8 OZ / 32 OZ
432	LORSBAN ADVANCED, RUP 2.5 GAL
5147	MALATHION 5EC, 1 GAL / 2.5 GAL
4832	MALLET (IMIDA E-PRO) 75WSP, 4 X 1.6 OZ
10677	MALLET 0.5G, 30LBS
3014	MOCAP 15G, RUP 30LBS
10517	MONTANA 2F, 1 GAL
4066	MOSQUITO BARRIER, 1 QT / 1 GAL
10751	MOVENTO 1 GAL

INSECTICIDES (CONTINUED)

ITEM	DESCRIPTION
2680	MUSTANG MAX, RUP 1 GAL
3905	OBERON 2SC EPA#264-719, 1 GAL
2700	ONYXPRO, RUP 1 QT
2519	PERM-UP 3.2EC, RUP 1 GAL
4483	PLATINUM 75 SG EPA#100-1291, 8 OZ / 32 OZ
3962	RADIANT, 1 QT / 1 GAL
3908	RIMON 0.83EC EPA#66222-35-400, 2.5 GAL
2579	SAFARI 20 SG, 3 LBS
5160	SEVIN XLR, 2.5 GAL
3992	SIVANTO 200 SL EPA#264-1141, 1 GAL
3123	VENOM, 1LB
3430	VYDATE L, RUP 2.5 GAL
1579	WARRIOR II, RUP 1 GAL

INSECT GROWTH REGULATORS

ITEM	DESCRIPTION
3521	ESTEEM 35WP, 10X5OZ

MITICIDE

ITEM	DESCRIPTION
10590	ABAMECTIN 0.15EC, RUP 1 QT / 1 GAL
5014	ABBA ULTRA, RUP 1 GAL
2617	ACRAMITE 50WS, 1 LB
2969	APOLLO SC, 1 QT
4117	NEALTA, 137 OZ
449	NEXTER, 2.06LB
5054	PORTAL XLO EPA#71711-40, 2.5 GAL
2619	SAVEY 50 DF, 12 OZ
3911	ZEAL MITICIDE WSP EPA59639-138, 4X30 OZ

PLANT GROWTH REGULATORS

ITEM	DESCRIPTION
2977	APOGEE, 5LB
2647	ETHREL, 1 GAL
2512	FRUITONE L, 1GAL
2927	FRUITONE N, 1.25 LBS
2959	MAXCEL, 1 GAL MAXCEL, 1 GAL
NEW	PROGIBB LV PLUS, 0.5 GAL
2674	PROGIBB 4%, 1 QT
2945	PROMALIN EPA#73049-41, 1 QT
2602	RETAIN, 0.73 LBS

***We stock other pesticides not listed.
Please call if you do not see what you need.***

CHEMICALS

RODENTICIDES



ITEM NO.	NAME	SIZE	PRICE
3238	Tomcat All-Weather Bait -1 OZ Chunks	4LB PAIL	\$23.99
3239	Tomcat All-Weather Bait -1 OZ Chunks	9LB PAIL	\$44.99

TOMCAT is tougher than a barnyard cat for controlling rats and mice. TOMCAT baits are manufactured with human food-grade ingredients and enhancers, for a bait so palatable that rats and mice can't resist. Containing the anticoagulant diphacinone, this multiple-feeding bait kills rats and mice in 4 to 6 days.



ITEM NO.	NAME	SIZE	PRICE
3236	Jaguar All-Weather Bait Chunks 9 LB Pail	9 LB. PAIL	\$65.49
3237	Jaguar All-Weather Bait Chunks 73 Count Pail	73 CT. PAIL	\$71.49

JAGUAR is tougher on rats and mice with the strongest single-feeding anticoagulant available in Brodifacoum. JAGUAR is especially successful in cleaning out tough mouse infestations or where resistance is suspected. Get guaranteed success with JAGUAR's tasty blend of more than 16 human food-grade ingredients.



ITEM NO.	NAME	PRICE
144	Revenge Rodent Smoke Bomb, 4 pack	\$7.50

Kills gophers, moles, rats, skunks, woodchucks and ground squirrels.



ITEM NO.	NAME	PRICE
2547	Deadline Bullets, 50 Lbs	\$100.00

Molluscicide contains no dyes and provides effective slug and snail control on field, fruit and vegetable crops. The molluscicide of choice for application in berries and vegetable crops. It remains effective after rain and watering.



ITEM NO.	NAME	PRICE
10714	Sluggo, 50 Lbs	\$133.50

The iron phosphate and bait combination immediately stops slugs and snails from feeding after the bait is eaten. The pests then die within a few days. Free-flowing pellets make it easy to spread throughout the garden, along vegetable rows and around ornamentals.



MAXSHIELD TYVEK SPRAY SUIT WITH HOOD & ELASTIC



ITEM	SIZE	PRICE
1809	SMALL	\$6.99
1811	MEDIUM	\$6.99
1810	LARGE	\$6.99
386	XLARGE	\$6.99
384	2XLARGE	\$7.99
385	3XLARGE	\$7.99
1858	4XLARGE	\$7.99
1878	5XLARGE	\$7.99
4044	5XLARGE	\$7.99
4045	6XLARGE	\$7.99
2045	6XLARGE	\$7.99

Made of a microporous laminate material, the double layer fabric provides superior liquid and dry particulate barrier protection while remaining flexible, breathable, and lightweight. Hood is attached.

SAFETY GOGGLES



ITEM	PRICE
520 CLEAR SAFETY GLASSES	\$2.95

Safety glasses protect from both high impact and chemical splashes; in direct venting

allows the air to move through the goggles for wearer comfort. Goggles can be worn over prescription glasses. Customizable elastic band fit. Meets ANSI Z87.1-2010 standard.

STANDARD DUST MASK



ITEM	PRICE
2296	\$4.35

Provides relief from dust and pollen. Has an adjustable nose clip and a nylon strap and is non-toxic.

ATLAS 772 NITRILE COATED GLOVES



ITEM NO.	SIZE	PRICE
3749	Medium	\$14.95
3750	Large	\$14.95
3751	X Large	\$14.95

Long-sleeved, nitrile coated gloves with textured finish for excellent grip. They have excellent abrasion and puncture resistance and has a cotton liner.

BOSS DISPOSABLE NITRILE GLOVES 8 MIL, BOX OF 50



ITEM	SIZE	PRICE
312	LARGE	\$11.99
313	MEDIUM	\$11.99
314	SMALL	\$11.99
1838	XLARGE	\$11.99

NITRI-SOLVE® GLOVES UNLINED, 22 MIL, 19"



ITEM	SIZE	PRICE
1883	XLARGE	\$8.99
1884	XXLARGE	\$8.99
1885	LARGE	\$8.99

BOSS WORK GLOVES



ITEM	SIZES	PRICE
309	Stallion (leather), Large	\$9.95
310	Stallion (pigskin), XLarge	\$9.95
10765	Stallion (pigskin), Large	\$9.95

WE CARRY SUNDSTROM RESPIRATORS FOR YOUR SAFETY NEEDS.
See inside back cover.

Rely on Corteva Agriscience for all your crop protection needs

Kerb[®] SC

HERBICIDE

Preemergence and early postemergence control of winter annual and perennial grasses, and preemergence control of broadleaf weeds.

Stinger[®]

HERBICIDE

Superior control of Canada thistle in cranberries. Unlike other herbicides, it can significantly reduce thistle populations next season.

Indar[®] 2F

FUNGICIDE

Protection that lasts with locally systemic and curative activity.

Delegate[®] WG

INSECTICIDE

Powered by the active ingredient spinetoram, Delegate is an essential tool to control numerous lepidoptera.

FERTILIZER

* We can not ship product to a state where the product is not registered. Please inquire for pricing. *

CUSTOM BLENDS AVAILABLE

BLENDED FERTILIZERS - GRANULAR

ITEM	DESCRIPTION - ALL IN 50 LB BAGS
2677	5-15-30 FERTILIZER
49730	6-12-6 A/S 1% MG & .2% B, CAULIFLOWER
2844	7-7-7 BLUEBERRY FERTILIZER
2882	10-10-10 ASM
3577	10-12-24 ASM CROP STARTER
4953	10-20-10 ASM CROP STARTER
2793	10-20-20 ASM FERTILIZER
4952	13-13-13-12S FERTILIZER
4865	14-7-14 ASM FERTILIZER
10843	16-8-8-16S FERTILIZER
4867	18-8-18 CS CRANBERRY FERTILIZER
2597	19-19-19 FERTILIZER
4326	20-10-20
4794	25-10-10 80%ESN
4799	28-7-14
4803	30-0-20 FERTILIZER

FERTILIZER INGREDIENTS

ITEM	DESCRIPTION - ALL IN 50 LB BAGS
10738	0-44-0 TRIPLE SUPER PHOSPHATE
2767/4470	0-0-22 KMAG / SUL-PO-MAG
539	0-0-50 POTASSIUM SULFATE/SULFATE OF POTASH
2578	0-0-60 POTASSIUM CHLORIDE/MURIATE OF POTASH
2828	11-52-0 MAP
480	21-0-0 AMM SULFATE GRANULAR
4928	46-0-0 UREA GRANULAR
10231	ALUMINUM SULFATE 17% 16%S
2634	BORON 15% GRANULAR
2908	CALCIUM NITRATE AG 15-0-0
3519	COPPER SULFATE 15% GRANULAR 6% S
3851	IRON SULFATE 50% FE, 5% S
3516	MANGANESE SULFATE 28% 6% S
3518	ZINC SULFATE 36% GRANULAR 5% S

FERTILIZER



ASM DENOTES MADE WITH AMMONIUM SULFATE & MICRONUTRIENTS.

OTHER GRADES AND CUSTOM BLENDS AVAILABLE.

FERTILIZER

FERTILIZER - SOLUBLE

ITEM	DESCRIPTION
2307	0-52-34 MONO POTASSIUM PHOSPHATE
1852	IRON SULFATE SOLUBLE, 50 LBS
4085	MOLYBDENUM, 5 LBS
3065	IRON CHELATE DP 10% SOLUBLE, 5LBS
2594	SOLUBOR (20.5%B), 50 LBS
4783	COPPER SULFATE FINE 25%, 50 LBS
3790	MANG. SULFATE 32% (TECHMANGAN), 55 LBS
4535	ZINC SULFATE 35% ZN 17% S, 50 LBS
3532	14-4-14 SOLUBLE, 25LBS
3533	17-4-17 SOLUBLE, 25LBS
2622	20-20-20 SOLUBLE FERTILIZER, 25 LBS
3531	25-5-15 SOLUBLE, 25LBS
2502	CALCIUM NITRATE GREENHOUSE, 50 LBS
2583	POTASSIUM NITRATE GREENHOUSE, 50 LBS
2627	4-18-38 SOLUBLE FERTILIZER, 25 LBS
2624	5-11-26 SOLUBLE FERTILIZER, 25 LBS
3049	9-45-15 SOLUBLE FERTILIZER, 25 LBS
2625	15-0-15 SOLUBLE FERTILIZER, 25 LBS
2628	15-10-30 SOLUBLE FERTILIZER, 25 LBS
2626	15-16-17 SOLUBLE FERTILIZER, 25 LBS
2621	20-10-20 SOLUBLE FERTILIZER, 25 LBS
3789	21-0-0 AMM SULFATE SPRAYABLE, 50 LBS
4813	46-0-0 FEED GRADE UREA, 50 LBS

SOIL AMENDMENTS

ALL 50 LB BAGS UNLESS NOTED.
MOST ITEMS ALSO AVAILABLE IN BULK.

ITEM	DESCRIPTION
567	SOLU-CAL PLUS ENHANCED CALCIUM (GRANULAR)
4367	SOLU-CAL HUMIC PLUS
11040	SOLU-CAL MAG
1861	SOLU-CAL S ENHANCED GYPSUM (GRANULAR)
2398	PELLETIZED LIME HI MAG
2852	PULVERIZED/AG LIME HI-MAG
5087	HYDRATED LIME
3515	PELLETIZED LIME HI-CAL
4798	PELLETIZED HIGH MAG LIME, SULFUR 90%



Solu-Cal SOIL AMENDMENTS WITH SOLUBLE CALCIUM AND ACTIVATED HUMIC ACID SOIL PH AND NUTRIENT DELIVERY SOLUTIONS

IDEAL FOR TURF, LANDSCAPES, TREES & SHRUBS, AGRICULTURAL CROPS, AND WILDLIFE FOOD PLOTS FOR IMPROVED NUTRIENT AVAILABILITY AND UPTAKE



Solu-Cal USA • www.Solu-Cal.com •   

SEEDS

Progressive Grower offers a wide variety of vegetable, forage, corn and turf seed.
We are proud to offer seeds from FS, King's Agriseeds and Albert Lea Seeds.

Please call for availability and pricing.

Here is a list of types of seed we have:

Perennial Mixes	Small Grains
Alfalfa	Meadow Fescue
Clover	Summer Annuals
Festulolium	Tall Fescue
Cover Crop Mixes	AND MORE!

The following seeds need to be pre-ordered:

Seed Potatoes by February 28th
Onion Sets by March 15th
Asparagus Root by March 15th
Sweet Potato Slips by March 15th
Garlic By August 30th

Please inquire about additional varieties not shown here.





PROGRESSIVE GROWER
carries a vast amount of organic offerings.

We are proud dealers for

**Albert Lea Seed, King's Agriseed, Fertrell
 Westbridge, Neptune's Harvest, Krehers, Nature Safe,
 Vermont Compost, Sungro, Pro-Mix to name a few.**

*We are constantly adding to our inventory.
 Please reach out to us if you don't see something
 in our catalog.*



While we do our best to research all of our products for use by organic growers, it is the responsibility of the farmer to determine if they pass USDA organic requirements before purchasing and using them. Some product that have OMRI or Nat'l List status can lose that standing at any time without notice. We are not responsible for products purchased that can not be used in certified OG operations. Check with your certifying agency for current status on a product. Not all of the products that we sell are registered in every state. It is your responsibility to comply with the laws of your state, check with your state department of agriculture if you are unsure.

**PRICES IN THIS CATALOG ARE
 SUBJECT TO CHANGE WITHOUT NOTICE.**



ORGANIC PRODUCTS



In 1989, we began composting as an alternative to handling and storing raw hen manure. For decades since, we have used the manure from our laying hens as a crop fertilizer on our farm. In Today, we continue our goal to be sustainable with the production of compost and fertilizer from our egg farms.



By-Product of Egg Farms
Composted, pelletized, and dried
into granular pellets



Flowable time-release,
low odor-low dust fertilizer that consistently
performs well from start to finish



Provides excellent nutritional value,
aids in improving soil structure,
and is approved for Organic usage

While their 5-4-3 and 5-4-3 Sunrise products are OMRI certified, their 4-3-10 and 8-2-2 have been reviewed and approved for use by Vermont Organic Farmers, LLC. Please check with your organic certifier before ordering any product for your organic needs.

ORGANIC PRODUCTS

KREHER'S GENERAL FERTILIZERS

8-2-2 KREHER'S

ITEM NO.	SIZE	PRICE
3553	50 LB BAG	\$26.95
3568	2000 LB SUPER SAC	\$955.00

Made from a blend of composted poultry manure and feather meal. Can be used for new turf, established lawns, and vegetables. Contains 8% nitrogen, 2% phosphate, and 2% soluble potash.

5-4-3 KREHER'S WITH 9% CALCIUM

ITEM	SIZE	PRICE
3524	50 LB BAG	\$15.95
4641	2000 LBS	\$450.00

Made from composted poultry manure with no other ingredients. Can be used on vegetables, trees, shrubs, flowers, and turf. Contains 5% nitrogen, 4% phosphate, 3% soluble potash, and 9% calcium. Quantities limited. Please order in advance.

4-3-10 KREHER'S POTASSIUM PELLETTED BLEND

ITEM NO.	SIZE	PRICE
3525	50 LBS	\$19.95
10230	2000 LBS Super Sac	\$725.25

Made from composted poultry manure and sulfate of potash. Good as a starter fertilizer for corn crop. Can be used on vegetables, trees, shrubs, and flowers. 4% Nitrogen, 3% phosphate and 10% soluble potash *Call for availability.

New! 7-2-6 Call for details!

5-4-3 KREHER'S SUNRISE

ITEM NO.	SIZE	PRICE
3569	50 LB Bag	\$15.95

Made from composted poultry manure and because of the dietary requirements of the hens it comes from, it contains higher amounts of calcium.

ORGANIC PRODUCTS



Neptune's Harvest fish hydrolysate is an all organic, highly nutritional protein fertilizer, made utilizing naturally occurring enzymes present in fresh North Atlantic fish. It's produced using a cold process employing enzymes (natural biological catalyst) which break down fish frames (the part left after the fillet is removed for human consumption) to simpler protein complexes. This process is called Hydrolysis.

The only manipulation the product goes through is stabilization with Phosphoric Acid to bring the pH down to 3.5, grinding, and hydrolysis. This process yields a stable, non-odorous, liquid fertilizer that is an easy to use, safe product. The nitrogen in Neptune's Harvest fish fertilizer is derived from fish protein in the form of amino acids which when added to the soil, slowly break down into basic nitrogen compounds. While a percentage of nitrogen becomes soluble due to the nature of the manufacturing process, no inorganic nitrogen has been added.

Fish Fertilizer 2-4-1

Fish & Seaweed Fertilizer 2-3-1

Seaweed Fertilizer 0-0-1

***Tomato & Vegetable Fertilizer 2-4-2**

**Meets NOP Standards*

ALL AVAILABLE IN

- 1 Gallon Container
- 5 Gallon Bucket
- 55 Gallon Bulk Drum
- 275 Gallon Tote



NEPTUNE'S HARVEST PRICING

ITEM	FISH FERTILIZER	PRICE
12221	1 Gallon Jug	\$47.25
3870	5 Gallon Bucket	\$102.38
3916	55 Gallon Drum	\$401.36
3872	275 Gallon Tote	\$1,705.00

ITEM	FISH & SEAWEED FERTILIZER	PRICE
4631	1 Gallon Jug	\$53.70
3871	5 Gallon Bucket	\$115.45
4736	55 Gallon Drum	\$516.86
12554	275 Gallon Tote	\$2,197.25

ITEM	FISH FERTILIZER	PRICE
4837	1 Gallon Jug	\$49.75
11724	5 Gallon Bucket	\$107.75
4403	55 Gallon Drum	\$422.65
4404	275 Gallon Tote	\$1,794.25

ITEM	TOMATO & VEGETABLE FERTILIZER	PRICE
13195	1 Gallon Jug	\$34.50
11969	5 Gallon Bucket	\$132.04
TBO	55 Gallon Drum	\$517.95
TBO	275 Gallon Tote	\$2,198.65

We are also proud to carry Neptune's Crab & Lobster Meal and Kelp Meal.

ORGANIC PRODUCTS

GENERAL FERTILIZERS

GRANULAR

ALFALFA MEAL 3-1-2, 50 LB BAG



ITEM NO.	PRICE
4573	CALL FOR PRICING

Dehydrated alfalfa has a high nutritional value and can be fed to a variety of livestock, poultry and horses.

KELP MEAL (THORVIN), 50 LB BAG



ITEM NO.	PRICE
3570	\$65.00

For soil nutrients: contains 60+ macro and trace minerals, vitamins, carbohydrates, plant growth hormones and a complex of 17 amino acids, nutrients are almost 100% available, can stimulate root development and plant growth, and helps retain soil moisture and reduces the effects of frost.

CRAB SHELL 2.5-3-0.5, 50 LB BAG



ITEM	DESCRIPTION	PRICE
13018	SHELL	\$43.00
10226	FLOUR	\$42.95

An excellent dry organic source of nutrients including Calcium and Magnesium. It retains moisture in the soil and builds the organic matter. It also gives the roots something to grab onto and wrap around for a food source, creating a deeper root system. Crab Shell will also keep slugs and snails off and it will help choke out weeds and keep moles, voles, mice, etc from digging up bulbs and root vegetables.

SUPER K, 3-4-7 X 2, 50 LB



ITEM	PRICE
10345 Super K xZ, B, 50lbs	\$29.75

Blended with crab meal for nematode control and high natural potassium required for larger fruited vegetables.

FISH MEAL 8-12-2, 50 LB BAG



ITEM NO.	PRICE
4115	\$87.45

A great natural fertilizer that is high in phosphorus and nitrogen. Fish meal is quick acting and offers a sustained supply of nutrients. Do not scatter fish meal, but plug it in a series of holes 10" deep that can be covered with about 4" of soil, as it has a strong odor.



ITEM	DESCRIPTION	SIZE	PRICE
12225	10-2-8 Coarse Grade	50 LBS	\$37.50
12886	10-2-8 Coarse Grade	2000 LBS	\$1,350.00
13096	13-0-0 Pelleted	50 LBS	\$33.50

See page 15 for Kreher's fertilizer options.

LIQUID

FERTRELL 3-4-3



ITEM	SIZE	PRICE
3792	5 GALLON	\$79.50
3793	1 GALLON	\$24.35

Made with kelp and humates.

LIQUID KELP



ITEM	SIZE	PRICE
4073	1 QT	
3795	1 GAL	
3794	5 GAL	

Not considered a fertilizer because the amounts of Nitrogen, Phosphorus, and Potassium are relatively low, contains growth plant hormones, vitamins, enzymes, and carbohydrates. It's a biostimulant, root system developer, and minor-nutrient deficiency cure. It can be used in conjunction with any water soluble spray. Reduce herbicide use by adding liquid kelp, yet maintain the same kill effectiveness.

NATURE'S SOURCE 3-1-1, 4.7 GALLON JUG



ITEM NO.	PRICE
4565	\$91.75

Ideal for a wide range of crops, promotes rapid nutrient response and hearty plant growth. Contains oilseed extract and has a low salt index. May be used as a foliar mist without worrying about burning or stretch. Mixes easily with cold water and has no strong odor.

NATURE'S SOURCE 10-4-3, 4.7 GALLON JUG



ITEM NO.	PRICE
10407	\$91.75

Contains oilseed extract, a renewable source of plant nutrition. Easier on plants, and on you. Lower in salts than most commonly used water soluble fertilizers and can be used as a foliar mist without burning or stretch. Also contains amino acids as well as calcium and magnesium to improve the plants' performance.



**SEE PAGE 16 FOR
NEPTUNE'S HARVEST
LIQUID FERTILIZER
OPTIONS.**

ORGANIC PRODUCTS



**PRODUCER OF NATURAL AND ORGANIC
FEED SUPPLEMENTS AND FERTILIZERS.**

**SOIL CONSULTING
FERTILITY PROGRAMS
RATIONS FOR ALL LIVESTOCK
NEED CUSTOM? WE HAVE YOU COVERED**

Fertrell[®]

SINCE 1946

Better Naturally!

Products are available through Progressive Grower.

ORGANIC PRODUCTS

BIOLINK[®] SPECIALTY PRODUCTS

ORGANIC TRIGGRR

ITEM NO.	Size	PRICE
10220	1 Gallon	\$102.15
TBD	2.5 Gallon	\$204.00
TBD	Drums/Totes	\$97.20/gal

Contains auxiliary soil and plant substances, it is formulated with kelp and other plant extracts for use on all plants to increase water and micronutrient uptake. Can be used on all crops including vegetables, fruit trees and vines, flowering and ornamental trees and shrubs, flowers and containerized plants, lawn and turf.

ORGANIC SEAWEED 0-0-4

ITEM	SIZE	PRICE
TBD	2.5 Gallon	\$28.75
TBD	Drums/Totes	\$27.95/gal

A liquid organic 29% seaweed fertilizer designed to improve root formation, soil conditions and enhance overall plant growth.

ORGANIC ALL-PURPOSE FERTILIZER 3-3-3

ITEM	SIZE	PRICE
10225	2.5 Gallon	\$80.25
TBD	Drums/Totes (30gal)	\$28.05/gal.

Provides 3% Nitrogen, 3% Phosphorus, 3% Potassium, and magnesium, copper, iron, manganese, molybdenum and zinc. Contains ingredients that help increase root growth, help increase new growth of stressed trees and vines, enhance seedling vigor, improve flowering, and overall plant growth.

ORGANIC ALL-PURPOSE FERTILIZER 3-3-3 PLUS WITH MICROS

ITEM	SIZE	PRICE
12970	2.5 Gallon	\$84.25
12182	Drums/Totes (30gal)	\$29.50/gal.

Provides plants with 3% Nitrogen, 3% Phosphorus, 3% Potassium, and magnesium, copper, iron, manganese, molybdenum and zinc. Contains ingredients that help increase root growth, help increase new growth of stressed trees and vines, enhance seedling vigor, improve flowering, and overall plant growth.

ORGANIC BIOLINK NITROGEN 3-0-0

ITEM	SIZE	PRICE
TBD	2.5 Gallon	\$27.25
TBD	Drums/Totes (30gal)	\$10.20/gal.

ORGANIC VEGAN ALL PURPOSE 5.5-0-0

ITEM	SIZE	PRICE
13087	2.5 Gallon	\$58.25
TBD	Drums/Totes (30gal)	\$22.30/gal.

ORGANIC POTASSIUM 0-0-6

ITEM	SIZE	PRICE
10224	2.5 Gallon	\$68.50
12183	Drums/Totes (30 gal)	\$22.65/gal.

ORGANIC PRODUCTS

**WE ARE CONSTANTLY ADDING TO OUR INVENTORY.
IF YOU DON'T SEE WHAT YOU NEED, PLEASE CONTACT US.**



Westbridge[®] *Effective Plant Nutrients and Biopesticides*



ORGANIC TRIGGRR[®]
Contains Auxiliary Soil & Plant Substances

ORGANIC BIOLINK[®]
Plant Nutrients & Adjuvants

SUPPRESS[®]
Herbicide EC

Botector[®]
Biofungicide

Blossom Protect[™]
Bactericide



FOR ORGANIC PRODUCTION



For more information, call (800) 876-2767 or visit www.westbridge.com

ORGANIC PRODUCTS

NITROGEN

NITRATE OF SODA 15-0-2, 50 LB BAG



ITEM NO.	PRICE
3011	\$35.90

Contains 15% of nitrate nitrogen, it improves the nutritional quality of crops by increasing protein, albumin, amino acids, vitamin B and micronutrient content. Nitrate of Soda also contains iodine and selenium, essential elements for human health.

FEATHER MEAL 13-0-0, 50 LB BAG

ITEM NO.	PRICE
5117	\$45.00

Good for crops that need steady, long lasting nitrogen. Because of its low water solubility, leaching is almost nonexistent. The nitrogen becomes available to plants through microbial activity. 13-0-0

BLOOD MEAL 12-0-0, 50 LB BAG



ITEM NO.	PRICE
3164	\$79.50

A fast release source of organic nitrogen. It should only be used on plants that have a high nitrogen requirement. Can also be used in compost piles to increase the speed of the decomposition process and also tends to act as a deer repellent.

PEANUT MEAL 8-1-1, 50 LB BAG



ITEM NO.	PRICE
3008	\$31.50

Medium release nitrogen.

POTASSIUM

SULFATE OF POTASH 0-0-52 SOLUBLE, 50 LB BAG



ITEM NO.	PRICE
4332	\$47.95

Is a mined rock that provides potassium and readily available sulfur. Soluble form for fertigation.

0-0-50 SULFATE OF POTASH OMRI LISTED

ITEM	SIZE	PRICE
4920	50 LB BAG	\$28.50
10219	1 TON	\$1,125.00

0-0-50 SOP Granular OMRI. A white granule that provides 50% potash and 17% sulfur to crops. It is chloride-free and has a low salt index, less than half that of Muriate of Potash. Potassium Sulfate is suitable for applications into fertility systems primarily for grapevines, tree crops, and vegetables.

0-0-22 SUL-PO-MAG 50 LB BAG, OMRI LISTED

ITEM NO.	PRICE
4895	\$37.00

Made of a soluble sulfate of potash magnesia. Apply the crushed mineral in areas where magnesium and potassium are deficient and calcium is abundant. Soil pH will remain the same.

PLEASE SEE PAGE 17 FOR LIQUID FERTILIZER OPTIONS. WE ARE ALWAYS ADDING TO OUR INVENTORY.

PHOSPHORUS

BONE CHAR 0-12-0, 50 LB BAG



ITEM NO.	PRICE
3010	\$25.00

Burned bone meal used primarily for water purification and refining sugar but also supplies the soil with phosphorus and calcium.

CALPHOS 0-3-0 20% CA, 50 LB BAG

ITEM	NAME	PRICE
4331	ROCK PHOSPHATE, 50 LB BAG	\$21.95

Pure mined rock phosphate for all flowering plants. Rock phosphate promotes root regrowth and is all natural and easy to apply. MAY BE LIMITED AVAILABILITY - PLEASE CONFIRM AVAILABILITY AT ORDER TIME.

ORGANIC PRODUCTS

MICRO/MACRO NUTRIENTS

WORM CASTINGS, 30 LB BAG



ITEM NO.	PRICE
4400	\$35.50

WORM CASTINGS, 30 LBS. This soil amendment provides a rich mixture of micronutrients, microbes and organic matter. It has an almost equal percentage of nitrogen, phosphorus and potassium. Calcium and magnesium are present as well. Use as a plant top dressing or add it to potting mix, houseplants, and raised beds.

ARAGONITE RAW, 50 LB BAG



ITEM NO.	PRICE
13023	\$15.50

Apply to the soil for a highly available source of calcium and trace minerals. Made of marl, which comes from the ocean.

KELP MEAL, 50 LB BAG

ITEM NO.	PRICE
3570	\$63.00

Conditions the soil, builds soil life, retains moisture and stimulates root and plant growth. It also improves yields and reduces the effect of drought and frost. Kelp Meal is made from dehydrated *Ascophyllum nodosum* seaweed, and it is not water soluble. The nutrients must be released by microbial activity.

MANGANESE SULFATE 0-0-0-18-32, 55 LB



ITEM NO.	PRICE
10511	\$73.75

For soils deficient in Manganese, apply this fast acting source of Manganese to the soil preplant or at planting.

SULPHUR



ITEM	DESCRIPTION	PRICE
2399	PASTILLE, 90%, 50 LBS	\$25.00
4309	TIGER, 90%, 50 LBS	\$23.50

Improved handling, high quality degradability and performance, soil amendment for alkaline soils, reduces soil pH. OMRI Listed.

BORON 10%, 0-0-0-10, 50 LB BAG

ITEM NO.	PRICE
4539	\$20.00

Derived from sodium calcium borate, non-acid forming. Side dress plants or broadcast across the garden.

AZOMITE GRANULATED NATURAL TRACE MINERALS, 44 LB BAG



ITEM NO.	PRICE
3446	\$26.75

Granulated AZOMITE is a natural mineral product mined from an ancient deposit in central Utah that is highly rich in trace minerals. A typical analysis reveals the presence of over 70 trace minerals that are both essential and beneficial to all plants. These minerals are often deficient in the soil (even the richest potting soil) and commonly

neglected in fertilizers. Adding Granulated AZOMITE to the soil increases the trace minerals plants need, and gives a big boost in fruit and vegetable yield, flowering, and overall health and vigor of plants. Granulated AZOMITE is certified for organic use and is sold in a convenient 44-lb bag for your lawn, garden, trees, or field crops in a non-dusty granule, suitable for use in broadcast spreaders or by hand. It is compatible for all organic gardening or farming programs.

SOIL & PLANT ENHANCERS

SELENIUM 0.06%, 50 LB BAG



ITEM NO.	PRICE
4537	\$13.95

Provides selenium for soil fertility.

CRAB & LOBSTER SHELL, 44LBS



ITEM NO.	PRICE
10226	\$42.00

Crab flour retains moisture in the soil and builds the organic matter. It also gives the roots something to grab onto and wrap around for a food source, creating a deeper root system. Will help eliminate ants, grubs, fungus, and root nematodes keep slugs and snails off and choke out weeds and keep moles, voles, mice, etc. from digging up bulbs and root vegetables.

DON'T FORGET TO CHECK OUT OUR SPECIAL VENDOR PAGES ON PAGES 15, 16, 19

ORGANIC PRODUCTS

SULFUR

ITEM NO.	DESCRIPTION	PRICE
2399	Pastille 90%, 50 LB Bag	\$25.00
4309	Tiger 90% 50 LB Bag	23.50

MENEFEE HUMATES, COARSE, 50 LB BAG

ITEM NO.	PRICE
3744	\$27.00

This rich, humus based granular soil conditioner improves acidity levels and acts as an organic chelator, which helps the plants utilize the nutrients in the soil. It also stimulates microbial growth. When used with balanced fertilization, Menefee Humate can significantly improve poor soils.

ZEOLITE, 50 LB BAG



ITEM NO.	PRICE
5118	\$33.25

Will cut fertilizer and water costs by holding the nutrients and water in the root zone until the plant is ready to utilize them, requiring less fertilizer and water to be applied. When used properly, Zeolite can also yield impressive results in regards to faster germination times, faster growth rates, larger plants, and crop yields and reduced fertilizer and water applications.

FUNGICIDES

ROOTSHIELD PLUS WP, 1 LB



ITEM NO.	PRICE
4753	\$275.00

Grows on roots, shielding them against root-damaging fungi, controls up to 12 weeks, and prevents control of major root diseases including soilborne Phytophthora sp. 0 hour REI 0 day PHI.

PURESPRAY GREEN



ITEM	DESCRIPTION	PRICE
10390	2.5 Gallon	\$25.00
10391	30 Gallon	\$300.00

Reduces the risk of leaf burn, the only spray oil listed by OMRI for use in organic production in the National Organic Program. Apply throughout the growing season, when done, it biodegrades leaving no harmful chemical residues.

MILSTOP, 5 LBS

ITEM	PRICE
4119	\$69.95

Potassium bicarbonate based with added surfactants for superior performance.

KALIGREEN, 5 LB BAG



ITEM NO.	PRICE
4235	\$68.50

Kaligreen is a contact-type fungicide for the control of powdery mildew. It contains micro-encapsulated potassium bicarbonate as the active ingredient and direct contact with the fungus is necessary for control. Potassium ion balance in the fungus cell is broken by Kaligreen; cell walls collapse, shrinking the cells and destroying the fungus.

DOUBLE NICKEL 55, 5 LB BAG



ITEM NO.	PRICE
3181	\$169.50

For use on fruit and vegetable crops as a broad spectrum preventive biofungicide for control of fungal and bacterial plant diseases. Can be applied up to and including the day of harvest.

REGALIA 2.5 GALLON



ITEM NO.	PRICE
2636	\$169.00

Regalia stimulates the plant's innate ability to fight diseases and delivers better yield and improved harvest quality. Offers preventative activity and early control of yield-robbing diseases and is recommended for use in specialty crops.

NU-COP HB, 10 LB

ITEM	PRICE
4080	\$60.00

Nu-Cop HB provides the most bio-available copper ions of any copper fungicide on the market to provide better disease control. For use on fruits, vines, berries, vegetables, nuts, and several field crops.

SERENADE ASO, 2.5 GAL.



ITEM	PRICE
2130	\$99.75

Applied as a preventative fungicide. Provides fungal and bacterial protection for all sized gardens. Use on roses, vegetables, fruits, flowering plants, trees and shrubs. Controls powdery mildew, rust, gray mold and

BADGE X2, 10 LB BAG



ITEM	DESCRIPTION	PRICE
2935	Organic	\$70.00

Advanced copper technology, Badge X2 is a low load dry copper formulation that is a mixture of two high purity copper salts, copper oxychloride and copper hydroxide. Known for its fast action and crop safety, possesses highly micronized and uniform copper particles resulting in increased adhesion to the plant surface. Highly water soluble dry formulation.

ORGANIC PRODUCTS

INSECTICIDES

ENTRUST SC, 1 QT



ITEM NO.	PRICE
2447	Call

Produced through the fermentation of spirosad, Entrust SC provides control of a huge range of insects. Registered for use on organically produced crops, it demonstrates good activity against pests like army worms, thrips, leaf-miners, codling moth, cherry fruit flies and Spotted Wing Drosophila. Provides pest specific control with a relatively low toxicity to nontarget organisms, including many beneficial insects. It won't cause a flare in mites, aphids, or other secondary pests. It is the only OMRI listed product that effectively controls worms, thrips and leaf-miners. Four hour re-entry interval.

ORG SLUGGO 1% IRON PHOSPHATE, 50 LB BAG



ITEM NO.	PRICE
10714	\$132.50

Contains 1% iron phosphate and 99% inert ingredients. Considered safe for humans and pets. Ingestion of Sluggo by slugs or snails will cause them to cease feeding, become less mobile and die.

MYCOTROL ESO, 1 QUART



ITEM NO.	PRICE
4505	\$103.00

Controls adult and immature stages of aphids, thrips, whitefly and more. Can be used in greenhouses, nurseries, for vegetables, landscaping and interiorscaping. Highest spore concentration in a Beauveria-containing insecticide. Unique mode of action- spores infect directly through the insects cuticle.

DIATOMACEOUS EARTH, 50 LBS

ITEM NO.	PRICE
4838	\$27.50

This fossilized diatom flour is abrasive and absorptive, razor sharp at the microscopic level, physically wears through insects' waxy outer cuticle. Absorbs insect's body fluids until it dies from dehydration, insects cannot develop immunity, less, odorless and permanent.

SURROUND WP 25 LB

ITEM NO.	PRICE
2450	\$34.00



Derived from kaolin clay, Surround WP forms a barrier film that acts as a broad spectrum crop protectant. It is labeled to control insect pests and disease while protecting against sunburn and heat stress. Coats the plants with a white powder film that creates a hostile environment for insects and mites and acts as an irritant and the film creates a physical barrier to insects

like psylla. For use on trees such as apples, pears, peaches, citrus, berries, and some field crops. Needs to be applied before pests arrive.

PYGANIC, 1 QUART



ITEM	DESCRIPTION	PRICE
4116	1.4 II, QUART	Call
2446	1.4 II, GALLON	Call
11725	5.0 EC, QUART	Call
2387	5.0 EC, GALLON	Call

PyGanic provides immediate insect control for organic farming and provides immediate control of more than 40 insects on over 200 crops. It's active ingredient is a botanical extract from a species of chrysanthemum plant family called pyrethrum. Pyrethrum provides fast knockdown and control of a broad spectrum of crop-damaging insects including aphids, leafhoppers, thrips, mites, beetles, Lepidoptera and whitefly.

DIPEL DF 1 LB



ITEM NO.	DESCRIPTION	PRICE
2487	1 LB	\$18.95
4982	5 LB	\$78.00

Dissolves better in water than wettable powders. Granulated, no dust or clumping when mixed. Specific to leaf eating caterpillars, DiPel controls gypsy moth tent caterpillars, cabbage looper, tomato hornworm, leafroller, and more. For use on vegetables, fruits, flowers, ornamentals, and lawns. Harmless to humans, animals, and beneficial insects.

TRILOGY (NEEM OIL), 2.5 GALLONS

ITEM NO.	PRICE
10838	\$125.00

Trilogy prevents fungal attack of plant tissue and contact activity to mite pressure on the plant.

AZAGUARD, 32 OUNCE

ITEM NO.	PRICE
12187	\$145.68

Broad spectrum insecticidal control on over 300 insect species.

AZERA

ITEM NO.	DESCRIPTION	PRICE
4560	QUART	\$95.00
4058	GALLON	\$325.00

Controls insects through three modes of action: contact, ingestion and insect growth regulatory activity.

BOTANICARD 22 WP, 1 LB

ITEM	DESCRIPTION	PRICE
4632	BOTANIGARD 22 WP EPA#82074-2, 1 LB	\$74.95

SUPPRESS HERBICIDE EC, 2.5 GALLON



ITEM NO.	PRICE
10222	\$175.00

A broad spectrum contact herbicide for post-emergent, non-selective weed control for use in and around all agricultural food and non-food crops. The formulation is a non-volatile, emulsifiable concentrate that provides rapid, effective control for various weeds.

ORGANIC PRODUCTS



Although we would love to have all Vermont Compost products in stock, our inventory is driven by popularity. We are able to get any VC product with enough advance notice.

VERMONT COMPOST FORT LIGHT COMPOST BASED POTTING SOIL

ITEM	SIZE	PRICE
4354	20 QUARTS	\$11.95
4355	60 QUARTS	\$29.85
4356	2 YARD SLING	\$611.00

Made for organic growers who want a compost-based growing mix. Uses include seed germination, transplanting vegetable and flower starts, and transplanting houseplants.

VERMONT COMPOST FORT VEE ALL PURPOSE COMPOST BASED POTTING MIX

ITEM	SIZE	PRICE
4359	20 QUARTS	\$11.95
4360	60 QUARTS	\$29.85
4361	2 YARD SLING	\$611.00

A compost-based soil with the handling and watering characteristics of a peat-perlite mix. Particularly good for growers using smaller celled flats or hanging baskets. Blended from composted manure and plant materials. Uses include seed germination, transplanting vegetable and flower starts, and transplanting houseplants.

VERMONT COMPOST SCREENED MANURE COMPOST

ITEM	SIZE	PRICE
10227	20 QUARTS	\$7.25
11638	2 YARD SLING	\$370.00

This compost blend is approved for use on certified organic farms and is the basis of all of the soil mixes at Vermont Compost. Premium compost comprised of carefully sourced, high-quality ingredients: a fully mature composted blend of bovine, equine, and avian manures, hardwood bark, late cut hay, spoiled silage, animal bedding, food residuals.

PLEASE INQUIRE ABOUT ADDITIONAL SIZES OF VERMONT COMPOST PRODUCTS.

BUILD YOUR DREAM GARDEN



*Model 749
w/ Rotary Plow*

Build raised beds with a BCS Two-Wheel Tractor and Rotary Plow attachment!



Four spiral blades spin at 290 RPM on a vertical shaft, easily busting sod or hardpan soil.



Rather than inverting soil layers like a bottom plow, the Rotary Plow chunks the soil and throws it to the right.

With other attachments, BCS will till, chip limbs, mow, blow snow, and more!



- All-gear driven.
- Front & rear mount attachments.
- Lifetime transmission warranty.

www.bcsamerica.com



TWO-WHEEL TRACTORS ONE TRACTOR. MANY USES. ALL MODELS AVAILABLE

BCS TRACTOR: HARVESTER 722

\$2,795.00



One of BCS's most popular models, the Harvester 722 is an excellent choice for those who want a combination of performance and versatility and don't foresee the need for the larger range of attachments powered by the Professional Series models. The 722 is powered with a Honda GX240 engine, two forward and reverse speeds, and an additional third transport speed when in rear-mount attachment mode. Ideal for adding an array of attachments such as the 26" Rear-Tine Tiller, 45" Sickle Bar Mower, Chipper/Shredder, Log Splitter, Dozer Blade and more. This model is limited in brush mowing applications due to its lack of a third working speed and Differential Drive. Battery not included.

- Easy-to-engage, shuttle-type reverse
- Anti-vibe handlebars that instantly adjust both vertically and side-to-side
- Fast transport speed
- Roto Tiller not included

BCS TRACTOR: PROFESSIONAL SERIES POWERSAFE 739

\$3,795.00



The PowerSafe model 739 features the coveted third working speed, giving owners increased operating efficiency with a faster, 2.7 MPH mowing speed. In addition to its three forward and three reverse speeds, the 739 also features turn-on-a-dime maneuverability with Differential Drive with Lockout.

The 739 features the Honda GX340 engine, available in recoil or electric start. The 739's PowerSafe clutch differs from standard models by utilizing a hydro-mechanical "wet" clutch instead of the spring-loaded, double-cone clutch. More difficult to overheat sitting in an oil bath and cooled by circulated oil instead of air, it's also better suited for implements requiring higher torque, such as the Flail Mower or Chipper/Shredder. The PowerSafe clutch is longer-lasting, backed by a five-year warranty for non-commercial users. Get smoother shifting, safer operation, and immediate stoppage when the clutch lever is released. As with all PowerSafe models, the 739 does not have a transport speed.

- Differential Drive with Lockout
- PowerSafe clutch for longer life and smoother operation
- Separate control to turn engine off
- Battery not included for electric start tractors
- Roto Tiller not included
- Three working speeds in both directions
- Stops power to the implement when the safety lever is released without shutting down the engine

BCS TRACTOR: PROFESSIONAL SERIES BCS 853 ELECTRIC

\$4,975.00



Powered by a Honda GX390 engine with recoil and electric start options, the 853 is BCS' most versatile tractor. Combining the best of both worlds, it offers a third working speed AND a fourth transport speed for maximum versatility. The BCS 853 gives you sufficient horsepower for all of the BCS implements, while also having the option of riding transport attachments like the utility trailer. In addition to the Differential Drive with Lockout being standard on all BCS Professional Series models, the 853 also features individual wheel brakes for increased maneuverability—especially helpful when making frequent turns. Transport speed can only be applied in rear-mount mode (tiller) on the 853.

- Fast transport speed for all rear-mount attachments
- Individual wheel brakes for turning and parking.
- Anti-vibe handlebars that instantly adjust both vertically and side-to-side
- Roto Tiller not included
- Differential Drive with Lockout
- Easy-to-engage, shuttle-type reverse
- Battery not included for electric start tractors

BCS TRACTORS: WITH DOZENS OF ATTACHMENTS



REAR TINE TILLER ATTACHMENT, 20" REAR TINE TILLER ATTACHMENT, 26"

\$735.00
\$795.00

- Tines rotate 50% faster than competitive brands at a rate of 20 rotations per wheel revolution
- Tine speed can also be adjusted to a 10:1 rotation ratio when in second gear
- Planar wedge in center of tiller breaks up center soil, leaving no un-tilled strip down the middle
- Tine disconnect with lockout stops tines from spinning during transport or when in reverse for safe operation
- Four tine depth settings, maximum of 8" tilled depth
- Replacement tine kits available



MODEL 749 (PS)

\$4575 RECOIL
\$4975.00 ELECTRIC

749 utilizes three forward and three reverse working speeds and Differential Drive with Lockout for increased maneuverability. The third working speed gives increased production efficiency, especially in mowing applications. As with all PowerSafe models, the 749 does not have a transport speed.

One of the main advantages model 749 has over smaller models, is individual wheel brakes for increased maneuverability.

- Differential Drive with Lockout
- Two wheel brakes on both handlebars
- PowerSafe clutch for longer life, smoother operation
- Stops power to the implement when the safety
- Separate control to turn the engine off



320 POWER HARROW, 32"

\$2400.00

The Power Harrow is the preferred seedbed preparation tool by many market gardeners. While the traditional BCS Rear-Tine Tiller mixes the soil with its vertically rotating tines, the Power Harrow's knives turn horizontally, stirring the soil like an eggbeater.

- Helps preserve soil structure by creating a larger particle size than that produced by the tiller
- Reduces weed seed germination by not bringing a new generation of seeds to the surface
- Gently levels and compacts the bed with its metal mesh roller

Now featuring the exclusive adjusting "Josephine" lever, the Power Harrow is easy to turn at the end of rows. The easy-to-use lever enables the operator to quickly reach the transport position at the end of the row. After the turn, the desired depth is re-established by

returning the lever handle to its previous notch. The Power Harrow's tine depth can be easily adjusted from 0 inches to 5 inches and also includes an integrated tang at the PTO connection point. The integrated tang has a wider bolt hole for the female tractor bushing, which provides a side-to-side "float" on uneven terrain. The gentle compaction of the mesh roller improves the performance of mechanical seeders. The roller also benefits the landscape industry by leveling uneven ground.

Required Accessory: Bumper Weight Kit for easier turning at the end of the row. A Quick Hitch Bushing is required.



360 ROTARY PLOW

ROTARY \$1495.00
SWIVEL ROTARY \$2195.00

This unique attachment is world-renowned for its superior performance, versatility and easy handling. Designed in Italy and nicknamed the "Groundblaster", the Rotary Plow accomplishes a multitude of tasks efficiently and effectively.

Four spiral blades spin at 290 RPMs on a vertical shaft, digging effortlessly into all types of soil — including hardened, rock-filled dirt that has yet to be broken. Debris is discharged to the right side, allowing the operator to build raised beds with multiple passes. The Rotary Plow engages the ground up to 12" deep, and can be regulated by a depth wheel that also provides easy transportation. The Rotary Plow can accomplish these tasks and more:

- Break new ground
- Power compost cover crops
- Build raised beds
- Create drainage ditches
- Power hilling
- Required Accessory: Wheel Extensions

EQUIPMENT

SUPER DELUXE FLATBED MULCH LAYER



Model SL43 with optional Drip Attachment



Model SL5450 Combination Sweet Corn Model

OUR TOP OF THE LINE SUPER DELUXE MULCH LAYERS FEATURE:

Heavy duty spring loaded drag gives a smooth, pressed seed bed and eliminates pot holes.

Furrow openers on bottom of drag give a consistent depth furrow and can't be pushed out of line by rocks.

High speed dirt shields

Drag is easy to remove for laying clear plastic over top of planted sweet corn or raised beds

Adjustable spring tension on plastic roll, 3" roller and 16" rubber tire press wheels keep plastic under constant pressure resulting in uniform and tightly laid mulch.

The cover disks are independently spring loaded and are fully adjustable.

Extra roll carrier enables machine to carry 2 - 4000' rolls of plastic mulch.

COMBINATION MODEL

Pull type with large transport wheels converts easily to 3 Pt Hookup by pulling 3 pins and removing the hitch. Spring assisted lever makes it easy to raise and lower the machine by hand when using it as a pull type. With used rubber tires and new rims. Steel transport wheels are optional for additional \$ 60.00

A FREIGHT CHARGE WILL APPLY TO ALL PRICES LISTED.

Model SL43	3 Pt Hookup	Adjustable, Lays 4 or 3 ft plastic	\$ 1030.00
Model SL54	3 Pt Hookup	Adjustable, Lays 5 or 4 ft plastic	1140.00
Model SL4300	Combination Model	Adjustable, Lays 4 or 3 ft plastic	1525.00
Model SL5450	Combination Sweet Corn Model	Adjustable lays 4 & 5 ft. plastic over sweet corn ridges. Furrow Opening Disks included.	1525.00
	SLP04+SLP02	Optional 4' Drag & Hangers for Model SL5450 for laying 4 ft. plastic flat	160.00

OPTIONAL ACCESSORIES

DRIP IRRIGATION ATTACHMENT	Fully adjustable drip feed-in tube. Roll carrier shaft is mounted on ball bearings, this prevents shaft from tearing into drip roll hubs. Adjustable brake gives accurate tension control and prevents drip roll from unwinding freely when machine stops.	SLA1	\$ 160.00
Double DRIP IRRIGATION ATTACHMENT		SLA2	280.00
ADJUSTABLE ROW MARKERS	Fits on all models	SLA4	90.00
CUSHIONED SEAT	Allows a helper to ride along to watch machine and change rolls	SLA3	110.00
FURROW OPENING DISKS	To lay clear plastic over planted sweet corn	SLA5	254.00
Stainless Steel Dry Fertilizer Hopper	To put granular fertilizer in the row (see page 24)	SLA8	465.00

OUR FREIGHT DISCOUNTS SAVE YOU \$\$\$ ON SHIPPING

COMPACT RAISED BED MULCH LAYER



RB448 with Drip Attachment



Spring loaded covering disks



With Double Drip



RB436 with Drip Attachment

Designed for use with compact tractors in high tunnels and fields where close spacings are desirable.

Features: Crowned bed is higher in center. Teflon lined bed press gives a smooth, pressed seed bed and eliminates pot holes.

Adjustable tension on plastic roll and independent spring loaded press wheels ensure plastic is stretched tightly.

Large cover disks are independently spring loaded and are fully adjustable to insure that plastic is covered securely.

Drip Irrigation Attachments feature adjustable feed in tube and tension adjustment. Flat free/foam filled press wheels.

Model RB448 Adjustable to lay 3 or 4 ft. wide plastic, Forms 4" high x 20 or 30" wide bed, 30-60hp recommended. \$ 1675.00

RBA1 Drip Irrigation Attachment for RB448 \$160.00 RBA12 Double Drip Irrigation Attachment for RB448 \$270.00

RBA4 Adjustable Row Markers for RB448 or RB436 \$ 148.00

Model RB436 Lays 3 ft. wide plastic, Forms 4" high and 20" wide bed, 20-40hp recommended. \$ 1230.00

RBA11 Drip Irrigation Attachment for RB436 160.00 RBA121 Double Drip Irrigation Attachment for RB436 270.00

Dirt shields standard on RB448, Optional on RB436 RBA2 \$ 80.00

Stainless Steel Dry Fertilizer Hopper

To incorporate granular fertilizers in the soil under 4' wide plastic mulch. Wheel drives off of plastic roll for consistent fertilizer flow.

For granular fertilizer. It will not work with powder.

Approximate 100-120 pounds capacity.

Adjustable flow, to control fertilizer rate.

(Fits year 2015 and newer models)

RBA5 SS Fertilizer Hopper for RB448 \$ 465.00

RBA5R SS Fertilizer Hopper for RBR440 465.00

Trailer Type for pulling with horses.

Goose neck tongue for easy turn around. Pulls easily with 2 horses.

Large spring loaded disks and large roller to shape and press bed make it easier to pull than typical bed press layers. Dual springs on the lift assembly ease the process of lifting the machine at the end of the row.

Floating rear discs are fully adjustable to assure good coverage.

Model RBR440 Lays 4' wide plastic and forms 4" high x 32" wide bed.

Black steel transport wheels are standard. **\$ 2260.00**

RBA1R Drip Irrigation Attachment 160.00

RBA12R Double Drip Irrigation Attachment 270.00

RBA4R Adjustable Row Markers 148.00



RoHand II Picking Assistant

Item #	Description	Price
RH02	Planting, Maintaining & Picking Assistant	\$4,599.00

RoHand II

Break Production Records While Lying Down on the Job!

Solar-Charged Cart for Endless Hours of Easy Operation



- ✓ Robust Speed Control for Soft Start/Stop and Overheat Protection.
- ✓ Foot-Controlled Variable Speed and Steering Keeps both Hands Free for Higher Productivity.
- ✓ Dual Gear Motors and Cleated Drive Tires Provide Torque and Traction for the Most Challenging Field Conditions.
- ✓ Compact Lithium Ion Battery for Years of Trouble-Free Service.
- ✓ Fully Adjustable Operator Platform and Head Support for All-Day Comfort.

- ✓ 4-Wheeled Design Adds Stability and Allows Easy On/Off Access from Both Sides of the Machine.

- ✓ Storage for up to 7 Strawberry Flats.

- ✓ Roll-Down Shade for Protection from Hot Sun or Rain.

Plant, Maintain & Harvest Your Produce

Jang JP-1 Push Seeder

- Accurately singulates a wide variety of raw and pelletized seeds with quick change seed rollers and easy adjustments
- Over 40 roller sizes available for various planting needs
- Weighs 25 lbs.
- Adjustable handle for height and offset
- Quick release hopper
- Clear plastic hopper to view seed level
- Adjustable depth control
- Hopper volume = 0.26 gal
- Singulates and spaces small seeds; saving time and money
- Seed sizing gauge on hopper lid for ease of roller selection
- No wasted seeds - can work with small amount in hopper



Item #	Description	Price
MSJ1	Jang JP-1 Push Seeder	\$380.00

Roller Pricing

A-6	\$ 23	R-24	\$ 26
AA-5	\$ 23	S-4	\$ 31
BL-32	\$ 23	U-4	\$ 31
C-6	\$ 33	X-4	\$ 21
C-12	\$ 28	X-6	\$ 21
F-6	\$ 29	X-12	\$ 33
F-12	\$ 23	X-24	\$ 25
F-24	\$ 23	XY-4	\$ 31
G-5	\$ 25	XY-12	\$ 31
G-12	\$ 29	XY-24	\$ 31
I-2	\$ 28	XY-36	\$ 41
J-4	\$ 23	XY-12	\$ 31
J-8	\$ 23	XY-24	\$ 31
L-12	\$ 23	XY-36	\$ 41
L-24	\$ 25	Y-4	\$ 31
L-6	\$ 23	Y-6	\$ 21
L-12	\$ 23	Y-12	\$ 21
L-24	\$ 25	Y-24	\$ 25
M-6	\$ 23	YX-4	\$ 31
MA-12	\$ 23	YX-6	\$ 21
MU-4	\$ 23	YX-12	\$ 21
MU-6	\$ 21	YX-24	\$ 25
MU-12	\$ 23	YY-6	\$ 21
MU-24	\$ 25	YY-12	\$ 21
MM-12	\$ 23	YY-24	\$ 25
MM-24	\$ 25	YY-32	\$ 21
N-6	\$ 31	YYX-4	\$ 25
Q-6	\$ 23	YYX-36	\$ 31
Q-12	\$ 21	Z-Blank	\$ 21
R-12	\$ 21	Custom	\$ 41

We are currently not stocking all rollers. But we can get them with a few weeks.

Spacing Chart for JP Series Seeders

* Spacing may change due to soil conditions

		Number of Teeth in Each Sprocket									
		14	14	13	13	11	11	11	10	10	9
Rear Sprocket											
Front Sprocket		9	10	10	11	10	11	13	13	14	14
Number Of Holes in Seed Roller	3 Hole	20	18	17	15	14	13	11	10	9	8
	4 Hole	15	14	13	12	11	10	8	7.5	7	6
	6 Hole	10	9	8	7.5	7	6.5	5.5	5	4.5	4
	12 Hole	5	4.8	5	4	3.5	3	2.8	2.5	2.5	2
24 Hole		2.5	2.5	2	2	1.8	1.5	1.3	1	1	0.5

* Shaded area shows inches between seeds

Seed Name / Seed of Comparable Size:	Recommended Roller	Seed Name / Seed of Comparable Size:	Recommended Roller	Roller	Hole Size	
					mm	Inches
Arugula	YX	Lettuce (Raw)	XY	A	13.5	17/32
Basil	YYJ	Mache	F	AA	12	15/32
Bean-Green	N	Mustard	YYJ	B	10	25/64
Beet	LJ	Okra	LJ	C	11	16-Jul
Broccoli	Y	Onion (Coated)	MJ	R	9	23/64
Cabbage	Y	Onion (Raw)	X	G	9	23/64
Carrot	Y	Pea	BL	Q	8	5/16
Carrot (coated)	MJ	Pepper	MJ	LJ	7.5	19/64
Cauliflower	Y	Radish	X	LJ	7	17/64
Cilantro	MJ	Rutabaga	Y	LJ	6	15/61
Chia	YYJ	Sorghum	MJ	MM	6	15/64
Collard	Y	Sorghum (Coated)	LJ	MJ	6	15/64
Corn	A, AA, N	Soy	BL	M	5	13/64
Cotton	C	Spinach	F	F	5	13/64
Cucumber	J	Sunflower	Send Samples	X	4	5/32
Cut Flower	Send Samples	Swiss Chard	LJ	Y	3.5	9/64
Flax	LJ	Tree Seed	Send Samples	YYJ	3	1/8
Kale	X	Turnip	YYJ	YX	2.5	7/64

Kreher Enterprises

Kreher's Farm Fresh Eggs is a family farm in upstate New York. We began composting in 1989 as an alternative to handling and storing raw manure as well as eliminating weed seeds. We then pelletize, dry and crumble the compost into a granular flow able time release fertilizer. Our KPF fertilizer is available in the all-purpose nutritionally balanced 5-4-3 with 9% calcium. A high K 4-3-10 blend, a high nitrogen 8-2-2. Also a 7-2-6 blend with slow release Nitrogen. All blends are available in 50# bags and totes. We also offer bulk sales of the 5-4-3 and the 4-3-10.



5-4-3	
Nitrogen	5%
% Soluble	2%
% Insoluble	3%
Phosphorus (P205)	4%
Potassium (K20)	3%
Micronutrients	
Calcium	160 LB/ton
Magnesium	13.90 LB/ton
Sulfur	14.60 LB/ton
Trace elements	
Boron	
Iron	
Manganese	
Copper	
Zinc	

- Excellent nutritional value
- Improves soil structure
- Performs well from start to finish
- Readily available nutrients
- Consistent finished product
- Low odor-low dust
- Approved for organic use
- Composted from laying hen manure to help increase micro-biology



We are a valued dealer for Rain Flo equipment.

We are able to match Rain Flo's catalog and website pricing plus freight.

Please remember to order your Rain Flo equipment in advance to allow for lead time.



2020 Machinery Price List

Model 2600 Series II RAISED BED Mulch Layer

2600A	Model 2600 with Auto RO-TRAK.....	1,825 Lb. Shipping Weight	\$ 5,400.00
2600M	Model 2600 with Manual RO-TRAK.....	1,775 Lb. Shipping Weight	\$ 4,800.00
2600-3ROW	Model 2600 Three Row Machine with flex hitch Tool Bar		\$ 16,900.00
2600BO	Bedder only, forms 4" to 8" high bed and 20" to 44" wide bed.....		\$ 3,550.00
3ROW-TBO	18' x 6" x 6" Tool Bar ONLY for three row machines		\$ 2,650.00

OPTIONAL ATTACHMENTS

142	Center of bed fillers with shear bolt.....	set	\$ 175.00
DRIP1	Drip irrigation attachment, with roll brake.....	For stainless steel down pipe, add \$ 40.00	\$ 285.00
DRIP2	Double drip irrigation attachment for two drip lines in one bed		\$ 385.00
2600CPP	Crowned raised bed		\$ 130.00
FII-GD-2600	Stainless steel dry fertilizer attachment, ground drive with speed selection		\$ 1,900.00
FII-HYD	Stainless steel dry fertilizer attachment, hydraulic drive for 3-row machines		\$ 1,800.00
604C	Manual row markers for 3-row machines		\$ 365.00
2600FA	Fumigation attachment, for weed control		\$ 500.00

Model 2550 Series II RAISED BED Mulch Layer

2550A	Model 2550 with Auto RO-TRAK.....	1,625 Lb. Shipping Weight	\$ 4,975.00
2550M	Model 2550 with Manual RO-TRAK.....	1,575 Lb. Shipping Weight	\$ 4,400.00
2550-3ROW	Model 2550 Three Row Machine with flex hitch Tool Bar		\$ 15,700.00
2550BO	Bedder only, forms 3" to 7" high bed and 20" to 34" wide bed, w/o plastic		\$ 3,150.00
3ROW-TBO	18' x 6" x 6" Tool Bar ONLY for three row machines		\$ 2,650.00

OPTIONAL ATTACHMENTS

2-142	Center of bed fillers with shear bolt.....	set	\$ 175.00
DRIP1	Drip irrigation attachment, with roll brake.....	For stainless steel down pipe, add \$ 40.00	\$ 285.00
DRIP2	Double drip irrigation attachment for two drip lines in one bed		\$ 385.00
2550CPP	Crowned raised bed		\$ 130.00
FII-GD-2550	Stainless steel dry fertilizer attachment, ground drive with speed selection		\$ 1,900.00
FII-HYD	Stainless steel dry fertilizer attachment, hydraulic drive for 3-row machines		\$ 1,800.00
604C	Manual row markers for 3-row machines		\$ 365.00
2550FA	Fumigation attachment, for weed control		\$ 500.00

Model 480 RAISED BED Mulch Layer

480A	Model 480 with Auto RO-TRAK.....	2,250 Lb. Shipping Weight	\$ 7,100.00
480-3ROW	Model 480 Three Row Machine with flex hitch Tool Bar		\$ 22,100.00
480-TBO	18' x 6" x 6" Tool Bar ONLY for three row machine		\$ 2,650.00

OPTIONAL ATTACHMENTS

DRIP1	Drip irrigation attachment, with roll brake.....	For stainless steel down pipe, add \$ 40.00	\$ 285.00
DRIP2	Double drip irrigation attachment for two drip lines in one bed		\$ 375.00
HYDD	Hydraulic Cover Disk Adjustment		\$ 750.00
604C	Manual row markers for 3-row machines		\$ 365.00

2 YEAR WARRANTY ON ALL RAIN-FLO EQUIPMENT
All Machine Prices Include Domestic Crating, FOB East Earl



2020 Machinery Price List

MODEL 2400 RAISED BED Plastic Mulch Layer

2400.....Model 2400 Mini Layer 1,025 Lb. Shipping Weight \$ 2,850.00

OPTIONAL ATTACHMENTS

2400 DRIP1..... Single Drip Irrigation Attachment.....For Stainless Steel Down Pipe Add \$40.00..... \$ 285.00
 2400 DRIP2..... Double Drip Irrigation Attachment..... \$ 385.00
 718SO..... Stainless Steel Drip Down Pipe Only..... \$ 72.00
 775S..... Center of Bed Fillers..... \$ 110.00

MODEL 345 SERIES II FLAT BED Mulch Layer

345FL..... Model 345 Machine 875 Lb. Shipping Weight..... \$2,075.00

345-3ROW..... Model 345 Three Row Machine with flex hitch Tool Bar \$ 8,400.00

OPTIONAL ATTACHMENTS

345 DRIP1..... Single Drip Irrigation Attachment.....For Stainless Steel Down Pipe, Add \$38.00..... \$ 285.00
 345 DRIP2..... Double Drip Irrigation Attachment..... \$ 385.00
 518SO..... Stainless Steel Drip Down Pipe Only..... \$ 67.00
 580..... Depth wheels to lay clear plastic over sweet corn..... \$ 190.00
 604C..... Manual row markers for 3-row machines..... \$ 365.00

CHALLENGER 1800 MULCH LIFTER

1800.....MODEL 1800 Standard Shear Bolt.....850 lb. Shipping Wt..... \$ 2,250.00

460..... Replacement plow shears, Left and Right (18" Deep-Suck)..... (Set) \$ 48.00

430..... Replacement disk blades and bolts..... \$ 25.00

459..... Replacement Side Disk Hub With Bolts..... \$ 68.00

50..... Replacement wheel, tire, and bearings..... \$ 52.00

Automatic Reset

#1800A.....MODEL 1800 Automatic Reset.....1,095 lb. Shipping Wt..... \$ 2,800.00

DRIP TAPE APPLICATOR

Model# 68185SDI.....5-Row 4"-18"SDI Applicator..... 4,290 Lb. \$9,100.00

Model# 6818SDI.....3-Row 4"-18"SDI Applicator..... 3,015 Lb. \$6,900.00

Model# 4810SDI.....3-Row 0-10"SDI Applicator..... 1,450 Lb. \$3,900.00

Model# 3803SDI.....3-Row 0-3"SDI Applicator..... 1,015 Lb. \$2,800.00

OPTIONAL ATTACHMENTS

RCD..... Optional Rear Closure Disk, For All Models 50 lb ea. \$ 145.00ea

2 YEAR WARRANTY ON ALL RAIN-FLO EQUIPMENT
 All Machine Prices Include Domestic Crating, FOB East End



2020 Machinery Price List

MODEL 1600 SERIES II WATER WHEEL PLANTER

1600.....3-Point Planter	1,100 lb. Shipping Weight	\$ 2,650.00
1600T.....3-Point & Trailer Combination	1,200 lb. Ship Wt	\$ 2,950.00
1600-3ROW	Model 1600 Three Row Machine with flex hitch Tool Bar	\$10,600.00
1600-TBO	18' x 6" x 6" Tool Bar ONLY for 3-Row Model 1600	\$ 2,650.00

OPTIONAL ATTACHMENTS

390.....	Top Rack Behind Tanks	\$ 120.00
390B.....	Wider Racks For Styrofoam Trays	\$ 175.00
379C.....	Side Ladder	\$ 90.00
340B.....	3rd or 4th Seat with double tray shelf.....each	\$ 260.00
327A.....	3rd & 4th Wheel Plumbing	\$ 55.00
384A.....	Trailer Hitch Kit Upgrade For 3-Point Planter	\$ 340.00

MODEL 1200 WATER WHEEL PLANTER

1200.....3-Point Planter	675 lb. Shipping Weight	\$1,850.00
1200T.....3-Point & Trailer Combination	750 lb. Shipping Wt.....	\$ 2,050.00

OPTIONAL ATTACHMENTS

TT1200	Top Rack Between Tanks	\$ 105.00
850C.....	Trailer Hitch Kit Upgrade For 3-Point Planter	\$ 210.00

PLANTING WHEELS FOR ABOVE PLANTERS

Part #355 (Specify Spacing) Planting Wheels With Spikes Welded in Place

Planting Wheels; 12", 15", 18", 24", 30", 36", 42", 48", 52", 60", 62", 72" with C Spikes....12" D Strawberry.....	\$ 135.00
Wheels not Standard Spacing or Spikes.....	\$ 160.00
Wheel Spacing Under 12".....	\$ 175.00

Planting Wheels with Adjustable Spike Spacing & Size (Order Snap-on Spikes Separate)

Spacing Below Based On "C" Spike; May Vary if Larger or Smaller Spike is Used

Without Spikes

Super Wheel for Snap-On Spike #355-S24								\$ 135.00
Plant Spacing	8"	16"	22"	28"	40"	77"		
Number Of Spikes Per-Wheel	12	6	4	3	2	1		
Super Wheel for Snap-On Spike #355-S26								\$ 135.00
Plant Spacing	6"	12"	17"	31"	45"	86"		
Number Of Spikes Per-Wheel	18	9	6	3	2	1		
Super Wheel for Snap-On Spike #355-S30								\$ 135.00
Plant Spacing	5"	10"	14"	19"	27"	35"	51"	98"
Number Of Spikes Per-Wheel	24	12	8	6	4	3	2	1

Extra Grommets Only #GROMMET.....\$ 0.58

Extra Snap Pins Only #239CLP.....\$ 0.08

GROMMETS INCLUDED FREE WITH EACH SUPER WHEEL!!

Also includes free snap pins to secure spikes if any trouble is experienced with the spikes popping out because of rocks, etc.

Planter Wheel Spike Sizes

Width @ Top →	← 2" →	← 1 1/2" →	← 1 1/4" →	← 1 1/8" →	← 1" →	← 1" →
Length →	↑ 6" ↓	↑ 5 1/2" ↓	↑ 4 1/2" ↓	↑ 4" ↓	↑ 3 1/2" ↓	↑ 2 1/2" ↓
Base →	← 4" →	← 3 1/4" →	← 2 3/4" →	← 2 1/4" →	← 2" →	← 1 3/4" →
Snap-On Spike →	3" Pots #392A/ \$9.00	2 1/2" Pots #392B/ \$8.00	*Standard* 50 to 72 Count tray #392C/ \$4.50	72 to 96 Count tray #392D/ \$4.50	96 to 128 Count tray #392E/ \$4.50	Seeds Welded wheels only. Not available with super wheels



EQUIPMENT



PL180 SUNDOWN BROADCAST SPREADER, 3 POINT HITCH, 350 LB

Category 1, 540 rpm. Corrosion proof poly hopper, stainless steel spreading disc with 4 steel vanes. Choice of 3 spread patterns, full center, left or right side. Spreading rates from 30-900 lbs per acre. Optional spread width limiter. Features a strong corrosion proof poly hopper. These spinner units have double levers and stainless steel slides which allow for spreading 180° or 90° to the right or left. They are ideal for even spreading fertilizer, seed, salt, and other flow-able materials. 350 lb. capacity, 5.9 cubic ft., 4.7 bushel capacity, spreading width up to 49'.

ITEM	PRICE
4351	\$550.00



PL400 SUNDOWN BROADCAST SPREADER, 3 POINT HITCH, 650 LB

Category 1, 540 rpm. Corrosion proof poly hopper, stainless steel spreading disc with 4 steel vanes. Choice of 3 spread patterns, full center, left or right side. Spreading rates from 30-900 lbs per acre. Optional spread width limiter. Features a strong corrosion proof poly hopper. These spinner units have double levers and stainless steel slides which allow for spreading 180° or 90° to the right or left. Ideal for spreading fertilizer, seed, salt, and other flow-able materials. 650 lb. capacity, 10.4 cubic ft., 8.3 bushel capacity, up to 49' spreading width.

ITEM NO.	PRICE
4352	\$595.00



SPREADER-HAND CRANK/COMM #3100/40 LB CAP

The 3100 Professional Hand Crank spreader is your ideal broadcast spreader when you need to spread granular material in wet areas, over uneven terrain, or in places a push spread could not go. With the EV-N-SPRED® PRO Dual Port Adjustable Shut-Off System, the user can infinitely balance the spread pattern based on material size, weight, and flight characteristics, and the Super-duty high-speed gearbox, spread widths of 15 ft./4.5 m. are common. Epoxy powder coated tubular steel chassis with integrated stand, wide comfortable carrying straps.

ITEM NO.	PRICE
2021	\$139.99



TEYME

Teyme's Cannon Sprayers are designed for application from a distance, allowing for the treatment of difficult to access crops.



DVTS CANNON SPRAYER

- Great for vegetables, grain, vineyards, and fruit trees
- Effective range of horizontal treatment up to 131 ft.
- Hydraulic left-right rotation from +85° to -15°
- Flexible variable hydraulic inclination
- Proportional distribution
- 20" double fan and fourteen jets
- Lift-mounted tanks from 105 to 264 gal. and trailed from 264 to 1056 gal.

Teyme's Airblast Sprayers are efficient and cost-effective, reducing drift as well as application time.

ASM1 AIRBLAST SPRAYER

- Great for vineyards and fruit trees
- Lift-mounted machine with reinforced steel frame
- High density polyethylene tanks from 53-158 gal.
- Two levels of mixing (pressure/return) achieve a constant and homogeneous mixture.
- Rinsing auxiliary tank (10%) and sanitary water tank
- 3-Point air flow rates up to 45,438 CFM
- 3-Point air units from 24" to 32"
- Three levels of filtering

J.S. Woodhouse Co., Inc. Since 1843
WOODHOUSE

EQUIPMENT

EARTHWAY® GARDEN SEEDER

An ideal row crop seeder, the 1001-B is a tool that takes the guesswork out of planting any row crop. Install one of the seed plates that best fits your seed, then adjust the depth of planting on the ground opener, and then set your 30" long row marker for the desired width, then fill the seed hopper with seeds and you're all set to begin.

Six Standard Seed Plates

(included with seeder): **ERT10**

Sweet Corn, **ERT12** Peas, **ERT11** Beans, **ERT07** Radish, **ERT08** Carrots and **ERT09** Beets.

Additional Seed Plates: **ERT34** Lima Beans, **ERT35** Popcorn, **ERT39** Broccoli, **ERT37** Lettuce & **ERT33** Cucumber.

Fertilizer attachment for Side Dressing.

Easily attaches to all Earthway garden seeders. Applies fertilizer above ground or below to a depth of 2".



ERT001
with ERT45



Item #	Description	Price
ERT001	Earthway® Garden Seeder, 12 Lbs.	\$99.50
ERT005	Fertilizer Applicator, 3 Lbs.	\$58.00
ERT45	Seed Plate Storage Case, mounts on	\$20.50
ERT06	Standard Seed Plate, Set of 6	\$23.20
ERT41	Additional Seed Plate, Set of 5	\$22.50
See desc. Individual Seed Plates, specify when ordering		\$6.50

EARTHWAY® HIGH WHEEL CULTIVATOR

The EarthWay® 6500W Kentucky Style High Wheel Cultivator features solid oak handles and a 24" steel wheel.

Three standard tools are included: Five tine cultivator, moldboard plow, and twin end plow.



ERT6500W



ERT60132

Item #	Description	Price
ERT6500W	Earthway® High Wheel Cultivator	\$130.00
ERT60132	Optional Weed Slicing Hoe, 2 Lb.	\$30.50

EARTHWAY® SEEDER SPREADER

- 20 Lb. Hopper capacity— zippered top, rustproof nylon construction
- Contoured molded base
- Adjustable shoulder strap
- Rocking agitator
- Spring loaded rate adjustment/shut-off



Item #	Description	Price
800	Earthway® Seeder/Spreader, 4 Lbs.	\$45.99

Item #	Description	Price
MGS01	Hand Planter, 8 Lbs.	\$58.95

CHAMPION SEEDER

Designed to direct seed beans into plastic mulch.

May also work for some other crops. 6" spacing with the option of removing every other spike for 12" spacing.

Has Earthway hopper

with 6 standard seed plates. See Earthway Seeder description.



Item #	Description	Price
CS001	Champion Seeder	\$639.00

POLYPLANTER

ITEM #	DESCRIPTION	PRICE
12252	Polyplanter Jr., 12 cup	\$550.00
12253	Polyplanter Jr., 6 cup	\$495.00

The Polyplanter Junior is a hand seeder that can be used by one person. The Junior will enable you to sow numerous seeds through plastic and o bare ground.



STAKE DRIVER

Heavy Duty Steel 2" ID pipe. 5/8" Handles.



Item #	Description	Price
TSD1	Stake Driver	\$27.95

STAKE PULLER

Lightweight tool to pull wooden stakes. Aluminum—only 4.5 lbs!



Item #	Description	Price
11726	Stake Puller	\$85.99

A freight charge may apply to the prices listed above.

SOLO 475 BACKPACK SPRAYER 4 GALLON



ITEM NO.	PRICE
2570	\$99.99

High-density polyethylene tank with ultra-violet inhibitors allows for unmatched durability and ultra-violet protection. Features a large 4.25" opening with filter basket. Shut-off valve and wand overall length of 28" for hard-to-reach places. 4' of high-pressure hose. Padded shoulder straps for greater comfort. The model 475 is capable of producing up to 60 psi, with its rugged connecting rod actuated diaphragm pump. The diaphragm is made of high-quality Viton for its resistance to harsh chemicals and abrasion and its long life expectancy. By design the diaphragm is able to pass small abrasive particles without damage to the pump assembly. The diaphragm pump is ideal for handling chemicals in wet table powder form, as well as liquid formulations.

SOLO 425 BACKPACK SPRAYER, 4 GAL



ITEM NO.	PRICE
123	\$95.99

High-performance piston pump for increased pressure capabilities. Extra large (4.25in) opening for easier filling & cleaning. 28" unbreakable wand & shut off valve. 48in high-pressure hose. Padded shoulder straps.

SOLO 417 BACKPACK MIST BLOWER



ITEM NO.	PRICE
12986	\$189.95

Solo 417 features a 4.5 gallon tank. Maintenance free 11V 7.2Ah lithium-ion battery, quick recharge in less than 3 hours. Adjustable pressure and output volume with two-step toggle switch. Whisper quiet and emissions free.

AG SPRAY ECONOMY SPOT SPRAYER, 25 GAL



ITEM NO.	PRICE
4387	\$119.99

25 Gallon corrosion resistant polyethylene tank, in tank filter system, 12 volt high-flow pump; 1.0 GPM; 35 PSI, economy handgun delivers up to 15 ft. horizontal spray, 15 ft. of 3.8 in. rubber hose, 8 ft. heavy duty wire harness with battery clips, tank drain, Roundup Ready.

ATV SPOT SPRAYER, 15 GALLON CAP



ITEM NO.	PRICE
1477	\$171.99

AG South Gold SC-15SS-GTNS Spot Sprayer, 15 Gal Polyethylene Tank. 15 gallon container, polyethylene tank, 15' hose length, 5" fill opening. 12V, 7A, 60 PSI, 2.1 gpm diaphragm pump. Pump includes 15" hose, handgun with adjustable tip, 96" lead wire, for insecticides and herbicides. Roundup Ready.

SOLO 430 HANDHELD SPRAYER



ITEM NO.	CAPACITY	PRICE
4151	1 Gallon	\$37.99
5051	2 Gallon	\$41.99
3901	3 Gallon	\$44.99

Designed for general purpose spraying. Viton seals, long hose, large pump handle and funnel top for easy filling. Includes an assortment of four nozzles. Adjustable for spraying a steam to a mist; Flat Fan for area and row application; Hollow Cone for shrubs and bushes; and Jet Stream for additional reach.

15" POLY 100PSI TRIGGER SPRAY GUN



ITEM NO.	PRICE
4029	\$13.99

15" Poly trigger spray gun, 3/8" barb inlet connection, 100 PSI max.

WE CARRY AN EXTENSIVE SUPPLY OF REPLACEMENT PARTS FOR SOLO SPRAYERS. PLEASE INQUIRE AND WE WILL ASSIST YOU IN FINDING THE RIGHT PART.

Battery Operated 12V Sprayers

All Units Feature: 12V Shurflo pump set at 100 PSI. 15' Hose with spray gun. Angled swivel nozzle, stream to mist. Connected wire leads with fused switch.

Spray Caddy: Battery-powered unit on 10" wheels. Includes 12V battery and regulated charger that prevents overcharging the battery. A convenient six gallon container that lifts out to fill and clean. Sprays approx. 18 gal / charge.

Portable Sprayers: Yellow tank (15 or 25 gal.), same components as spray caddy. Connects to 12 Volt battery. Ideal to mount on a garden cart, ATV, etc.

Item #	Description	Price
SUP5	Spray Caddy, 6 gal. tank	\$330.00
1477	Portable Sprayer, 15 gal. tank	\$195.00
SUP25	Portable Sprayer, 25 gal. tank	\$220.00



Superior Tech



AUTHORIZED DISTRIBUTOR OF MECHANICAL TRANSPLANTER CO.



These versatile top-of-the-line seeders are perfect for home gardens and farm markets. Units accurately singulate a wide variety of raw and pelletized seeds with quick change seed rollers/plates and easy adjustments. Multiple roller sizes are available for various planting needs. With clear, durable plastic hoppers to view seed levels and adjustable depth control, Push- and Toolbar-Mounted Seeders from Mechanical Transplanter let you plant quickly and accurately, saving time and money.

Contact us for more information & affordable pricing. Stop by our retail store to check out floor models and options.

Competitively Supplying Your Growing Needs
INFO@PROGRESSIVEGROWER.COM (508) 273-7358

DRAMM® MINI AUTO FOG™

The Dramm Mini AutoFog is an easy to use, low volume chemical applicator designed with smaller greenhouses in mind. It can treat 5,000 sq. ft. automatically without an operator present. It can easily apply a wide variety of chemical formulations using a highly concentrated spray solution. A specially designed nozzle generates billions of micro-particles (0.05 - 10.0 microns) that fill the entire treatment area with active chemical. These tiny particles ensure complete and even coverage of all plant surfaces. This "low-volume" method of applying chemical solutions eliminates costly run-off and reduces the amount of chemical needed. 24 Hour timer, starts and stops automatically. Durable oilless compressor for even supply of air. 60 rpm mechanical agitation—keeps chemicals in suspension.

Standard Treatment Area: Up to 5,000 sq. Ft. (7,000 sq ft with circulation fans)

Nozzle: Air atomizing, outputs 8 liters in 4 hours.

Adjustable Nozzle Height: 5-7 ft.

Tank size: 8 Liters (8.45 quarts)



Item #	Description	Price
DFA10	110 Volt Mini AutoFog™	\$3150.00

DRAMM® K-10 PORTABLE PULSFOG®

The PulsFOG thermal fogger is perfect for the rapid application of greenhouse chemicals. Designed to expel chemicals at great distances and speed, reduces application time and ensures even coverage of all surfaces with a highly dense, visible fog.

Perfect for the application of insecticides, fungicides, and disinfectants.

Propels chemical: 45 ft with NutriFog, 100 ft with VK-1 (more with the help of circulation fans)



Item #	Description	Price
DFP10	25 Hp 2.6 gallon Thermo Fogger	\$2,795.00

PULSFOG® DILUENT SOLUTIONS: For best results, the PulsFOG requires the use of carrier solutions- or fog enhancer's. These solutions help to create more even particle size, distribute the solution throughout the area, and retard evaporation of fog droplets. Some chemicals may not require additional carrier solutions due to their formulation. Check with your chemical supplier for more in-depth information.

NUTRIFOG

This carrier is a 10-3-3 Foliar Fertilizer. It can be used with all chemical formulations. It is safe on ornamentals, fruits & vegetables.

Do not use more than five times in one month on the same crop.

Rates for NutriFOG:

- 0.25 Quart NutriFOG Solution
- 1.75 Quarts Water
- Apply above mix into 10,000 square feet of area

VK-1 CARRIER SOLUTION

For use with E.C. chemicals only (emulsifiable concentrate). Never Mix Water with VK-1. Plants should be dry and remain dry for 8 hours. VK-1 mixtures will be airborne for approx. 6 hours. It is very effective for flying insects: white fly, thrips, and leaf minor.

Rates for VK-1: 1 Quart VK-1 Carrier Solution

- Chemical for 10,000 Square Feet
- Apply above mix into 10,000 square feet of area

Item #	Description	Price
DFPNF	NutriFog, 5 gallon pail	\$299.00

Item #	Description	Price
DFPK1	VK-1, 5 gallon pail	\$225.00

CHEMILIZER PROPORTIONAL INJECTOR, 11 GPM

The big advantage of this unit is that the chemical pump takes all the abuse of the chemicals and is easy to disassemble or replace by hand. Parts are inexpensive, too. The water powered motor is never contaminated by any chemicals and comes with a 2-year warranty. This proportional fertilizer injector automatically compensates for any change in water pressure or flow to provide a constant mix at 1:100 rate.

Max Temperature: 100° F **Standard pump:** fixed ratio 1:100.

Flow Rate: 1.2 – 660 gph (0.02 – 11 gpm) **Operating Pressure:** 3 – 85 psi.

Connections: 3/4" male hose thread.

Item #	Description	Price
CPI12	Chemilizer Unit (Model CH9000-210), 1:100	\$240.00
12268	Bypass for Chemilizer, FHT x MHT, this plumbing comes with three valves, filter, and check valve.	\$60.00
CPI120	Cart Unit: Includes Chemilizer, bypass, 6 gal. tank, and push cart.	\$395.00



DOSMATIC SUPERDOS PROPORTIONAL INJECTORS

SuperDos operates without electricity to precisely inject liquid concentrates into a water supply line using fluid flow as the power source. SuperDos is designed with a patented internal mixing chamber that promotes homogeneous mixing, while segregating harsh chemicals from critical internal components. These proportional fertilizer injectors automatically compensate for any change in water pressure or flow and provide a constant mix at the rate you set. **Replacement parts in stock. We service in store.**



Item #	Description	Injection Ratios	Flow Rates	Operating PSI	Price
DSD20	SuperDos 20, 1" MPT	1:40 – 1:500	0.05 – 20 gpm	5 – 100	\$365.00
DSD20Bypass	On/off handle for DSD20	-	-	-	\$36.00
12608	SuperDos 30, 1" MPT, On/off handle installed	1:40 – 1:500	0.15 – 30 gpm	5 – 100	\$495.00
DSD45	SuperDos 45, 1 1/4" MPT, On/off handle installed	1:40 – 1:500	0.50 – 45 gpm	5 – 100	\$740.00

MIXRITE PROPORTIONAL INJECTOR, 11 GPM

This fixed ratio 1:100 offers an alternative to the Chemilizer with similar specifications.

This proportional fertilizer injector automatically compensates for any change in water pressure or flow to provide a constant mix at 1:100 rate. **Standard pump:** fixed ratio 1:100. **Flow Rate:** 10.2 – 660 gph (0.17 – 11 gpm)

Operating Pressure: 6 – 120 psi. **Connections:** 3/4" male thread.

Also available upon request: 22 GPM, 45 GPM and 110 GPM units.

Item #	Description	Price
MR11	MixRite Unit (Model 556AG), 1:100	\$228.00
DOS1	Bypass for MixRite, FHT x MHT, this plumbing comes with three valves, filter, and check valve.	\$60.00
11717	Cart Unit: Includes MixRite, bypass, 6 gal. tank, and push cart.	\$383.00

MixRite



HANDHELD PH & EC METERS

PH Meters: Easily measure pH and temperature.

EC Meters: Easily measure EC (electrical conductivity), TDS (total dissolved solids), and temperature. Often used to determine if an injector is working correctly.

Item #	Description	Price
PHM080	Economy pH meter, 0.2 pH accuracy,	\$52.00
PHM200	Professional pH meter, 0.02 pH accuracy, waterproof	\$80.00
PHMST	PH Meter Storage Solution, 2oz Bottle	\$7.50
PHMBS	7.0 PH Buffer Solution, 20ml packet	\$2.00
13009	Economy EC meter, +/- 2% accuracy	\$35.00
13008	Professional EC meter, +/- 2% accuracy, waterproof	\$63.00
13007	EC Meter Calibration Solution, 20ml packet, 1000PPM	\$2.00



DOSATRON® PROPORTIONAL INJECTORS

Dosatron® has been serving the horticulture industry for over 35 years and has established itself as the industry standard. Durable and reliable, these units come with common wear parts included. These water powered proportional fertilizer injectors automatically compensate for any change in water pressure or flow and provide a constant mix at the rate you set. Ratio is easy to adjust by hand with lock to ensure your setting isn't changed accidentally. Ideal for fertilizers, fungicides, acids and more. Maximum Temperature: 104° F

Wear part replacement kits in stock.



Item #	Description	Injection Ratios	Flow Rates	Operating PSI	Price
13208	D25F1, 3/4" MPT (Our most precise 11 gpm unit)	Fixed 1:100	0.04 – 11 gpm	4.3 – 85	\$, \$275.95
DOS110	Cart Unit: DOS11, bypass, 6 gal. tank, and push cart.	–	–	–	\$, \$431.95
13209	Dosatron D14M22, 3/4" MPT	1:50 – 1:500	0.04 – 14 gpm	4.3 – 85	\$338.00
DOS140	Cart Unit: DOS14, bypass, 6 gal. tank, and push cart.	–	–	–	\$493.00
DOS1	Bypass assembly for DOS11 and DOS14; FHT x MHT includes three valves, filter, and check valve.	–	–	–	\$60.00
DOS20	Dosatron D45RE15, 1" MPT, On/off handle installed	1:66 – 1:500	0.4 – 20 gpm	7 – 70	\$495.00
DOS40	Dosatron D8RE2, 1 1/2" MPT, On/off handle installed	1:50 – 1:500	2.2 – 40 gpm	2.2 – 116	\$780.00

MIXRITE 568AG WATER POWERED PROPORTIONING PUMP



ITEM NO.	PRICE
5038	\$235.00

Made with chemically resistant nylon and a reinforced fiberglass body, the parts are easily replaceable. High operating range from 2.9 PSI to 120 PSI, it has hose barbs with swivel for easy installation. Fixed injection is .8%, flow rate is from .08 to 11 gallons per minute, includes a 7', 3/8" inlet tubing with foot valve strainer.

MIXRITE 571 WATER POWERED PROPORTIONING PUMP



ITEM NO.	PRICE
2809	\$317.00

.38 - 2.5oz/gal with On/Off. Accurate dispensing, uses only 20% of pressure to drive the pump, no electricity required, low maintenance and easy to adjust. Made of chemically resistant nylon and a fiberglass body, all seals are specifically designed to withstand car-wash additives, the parts are easily replaceable, hose barbs with swivel for easy installation, and injection from 500:1 to 1:10.

MIXRITE 66AG FERTILIZER INJECTOR



ITEM NO.	PRICE
2840	\$239.00

Designed for water flow up to 11 GPM and a wide array of chemical and other additives. A true hydraulically powered ejector. No electricity is required. A true proportioning injector. Automatically adjusts the rate of injection to maintain the same fertilizer proportions.

MIXRITE TF-5-002 FERTILIZER INJECTOR



ITEM NO.	PRICE
2810	\$495.00

MixRites are water driven injectors that use water pressure as the power source, not electricity. A proportional amount of additive is injected into the water line regardless of flow variation, creating a homogenized solution. All seals are designed to withstand harsh chemical additives and the body is made of chemically resistant nylon-fiberglass body.

MIXRITE TF-10-002-1.5 FERTILIZER AND CHEMICALS INJECTOR



ITEM NO.	PRICE
2811	\$730.00

The TF 10 Series are designed for medium water flow for fertigation, pesticide, and other in-line additives. They are intended for typical fertilizers, pesticides, and agriculture or irrigation additives. They are not designed for strong acids, alkalines, or solvents. The TF 10 is designed for water flow up to 45 gpm and has 1.5" NPT threaded connection for in-line mounting.

PVC Ball Valves



Item #	Size	Price
Threaded:		
11417	½" FPT	\$1.98
10826	¾" FPT	\$2.60
10827	1" FPT	\$3.95
11418	1¼" FPT	\$4.95
10684	1½" FPT	\$6.75
10818	2" FPT	\$8.40

Item #	Size	Price
Socket:		
11419	½" SOC	\$1.98
11420	¾" SOC	\$2.60
11421	1" SOC	\$3.95

PVC Union Ball Valves



Item #	Size	Price
11422	½" SOC	\$6.07
11423	¾" SOC	\$6.84
11424	1" SOC	\$9.52

Brass Ball Valves, FPT



Item #	Size	Price
11425	½" FPT	\$5.50
11426	¾" FPT	\$7.25
11427	1" FPT	\$11.00
11428	1¼" FPT	\$17.00
11429	1½" FPT	\$23.00
11430	2" FPT	\$32.00

Brass Ball Valves, Insert



Item #	Size	Price
11431	¾"	\$11.30
11432	1"	\$14.50
11433	1¼"	\$23.80

Brass Swing Check Valve

Full flow, FPT x FPT



Item #	Size	Price
11434	½" FPT	\$6.50
11435	¾" FPT	\$7.00
11436	1" FPT	\$9.75
11437	1¼" FPT	\$14.50
11438	1½" FPT	\$17.25
11439	2" FPT	\$24.50

Brass Boiler Drain Valves

MPT inlet x Male Garden Hose Thread outlet.



Item #	Size	Price
11440	½" MPT Base	\$4.50
11441	¾" MPT Base	\$4.75

Frost-Proof Hydrants

High capacity, top-quality blue hydrants from Boshart Industries. Bury Depth: 3'. MHT outlet x FPT inlet (listed below as size.)



Item #	Size	GPM	Price
11442	¾"	20	\$78.00
11443	1"	28	\$88.00

Brass Hydrant Fittings:

Item #	TEE, Insert x MPT	Price
11444	¾"	\$7.50
11445	1"	\$8.75
11446	1" x ¾"	\$9.00

Item #	Ell, Insert x MPT	Price
11448	¾"	\$6.00
11449	1"	\$8.50
11450	1" x ¾"	\$8.50

Pressure Regulators

These pre-set regulators maintain constant pressure and automatically adjust to flow conditions. **Note:** If water is turned off or flow drops below the flow GPM range these regulators will not regulate the flow.



Item #	Size	PSI	GPM Range	Price
3020	¾" FPT	20	0.5-15	\$8.90
PR 007355	¾" FPT	35	0.5-15	\$8.90
4447	1" FPT	20	2-20	\$11.50
11452	1" FPT	35	2-20	\$11.50
10689	1½" MPT	20	7-35	\$30.50
10406	1½" MPT	35	7-35	\$30.50

Plastic Spin-Clean Filters



Even well water, or other sources of clean water require filtration for irrigation, especially for permanent or reusable systems. Two-piece threaded housing with O-ring seal for easy maintenance. Strong, stainless steel screens. High Pressure: up to 80 PSI. Ball valve for flushing. All repair parts in stock. **Standard Screen:** 150 mesh (100 microns). 200 mesh optional.

Item #	Size	Max Flow	Price
10402	¾" MPT	9 GPM	\$19.50
10403	1" MPT	18 GPM	\$19.80
10404	1½" MPT	55 GPM	\$140.00
10401	2" MPT	90 GPM	\$150.00

Plastic Screen Filter

Lightweight stainless steel screen. Housing threads apart for easy screen removal for cleaning. 155 mesh standard. Replacement screens in stock.



Item #	Size	Max Flow	Price
10417	¾" FHT x MHT	7 GPM	\$10.50

Battery Operated Controllers

Commercial grade, waterproof, constructed of high impact plastic, these controllers operate on two AA alkaline batteries for up to 3 years. No AC power source required! Fully featured automatic, semi-automatic and manual operation easily programmed with five buttons and easy to read LCD display. Connection: 2 wire.



Single Station with Valve (For specs on valves see listing below.)

Item #	Description	Price
11453	Controller with 3/4" valve	\$100.00
11454	Controller with 1" valve	\$101.00
11455	Propagation Controller with 1" valve	\$108.90
11456	Controller with 1 1/2" valve	\$168.30
11457	Controller with 2" valve	\$177.10

Multiple Station (Order valves separately below.)

Item #	Description	Price
11458	Four Station Controller with waterproof cables	\$94.95
11459	Six Station Controller with waterproof cables	\$104.95

Battery Operated Valves, 2 Wire DC

Heavy duty plastic valves with DC latching solenoid for the above controllers. They feature a manual flow control valve and are normally closed. Connections are all FPT x FPT. Operating Pressure: 10 – 150 PSI.



Item #	Description	Flow Range	Price
11460	3/4" DC Solenoid Valve	0.1 – 28 GPM	\$39.95
11461	1" DC Solenoid Valve	0.2 – 35 GPM	\$42.95
11462	1 1/2" DC Solenoid Valve	20 – 135 GPM	\$82.95
11463	2" DC Solenoid Valve	30 – 160 GPM	\$89.95

Toro® EVOLUTION® AG Series Controller (Use with 24VAC valves)

Introducing a simple, intuitive and economical controller that gives agricultural and horticultural growers the features they need now! The EVOLUTION® AG, built on the award-winning Evolution platform, allows for modular expansion, fertilizer injection, pulse irrigation, **propagation and misting schedules**, along with the freedom to program valves to your specific needs: from 1 second to 24 hours. Full Toro Support for programming questions —please call: 877-345-8676. Features a lockable, weather-resistant case. Can run 3 separate programs. Adjust schedules +/- by percentage. Schedule Options: Weekly, Interval, or Looping. Automatic or manual operation.

Optional accessories (not in stock): Wireless soil sensor, wireless weather sensor, wireless handheld remote, wireless auxiliary relay, Smart Connect® plug-in receiver.



Item #	Description	Price
10464	Four Station Evolution Controller	\$217.50
11465	4 Station Module (to add-to controller)	\$39.95
11466	12 Station Module (to add-to controller)	\$114.95

Indoor 6 Station AC Controllers

Requires 120 volt AC input and has 24 VAC output for valves, has one 9 volt battery for backup and programming. Fully featured automatic, semi-automatic and manual operation easily programmed with four buttons and easy to read LCD display. AC valves sold separately, see below.



Item #	Description	Price
10456	Six Station AC Controller	\$54.95

Electric Solenoid Valves, 24 VAC

These heavy duty plastic valves have manual flow control valve and are normally closed. All connections are FPT.

Operating Pressure: 10 – 150 PSI.

11468



Item #	Description	Flow Range	Price
10457	3/4" AC Solenoid Valve, 24V	0.1 – 28 GPM	\$20.00
11468	1" AC Solenoid Valve, 24V	0.2 – 35 GPM	\$20.50
11469	1 1/2" AC Solenoid Valve, 24V	20 – 140 GPM	\$61.50
11471	2" AC Solenoid Valve, 24V	30 – 170 GPM	\$68.50

Battery Garden Hose Controller

This heavy duty plastic garden hose controller has standard FHT x MHT connections. Operates on one 9V battery, which can last up to one year. Automatic and manual operation. Easy to set with four buttons and an easy to read LCD display. Max Pressure 80 PSI. Flow rate up to 5 gpm at 30 PSI.



Item #	Description	Price
9847	B09D Battery Garden Hose Controller	\$44.95

Mechanical Garden Hose Timer

The Dramm® garden hose timer is simple to use, just turn the dial to desired watering time (up to 2 hours) and the timer will automatically stop the water flow at the time you set. Max flow rate: 5 GPM.



Item #	Description	Price
10808	Mechanical Garden Hose Timer	\$18.95

Blue Layflat

This general purpose blue layflat is a lightweight, tough, and economical water discharge hose great for main supply lines. It will not rot or mildew and coils flat for easy storage.

Item #	Description	Max PSI	Roll Wt.	Price	3+ Rolls
LAY015	1½" x 300' Blue Layflat	80 PSI	48 Lbs.	\$94.00	\$90.50
3643	2" x 300' Blue Layflat	80 PSI	63 Lbs.	\$106.00	\$102.00

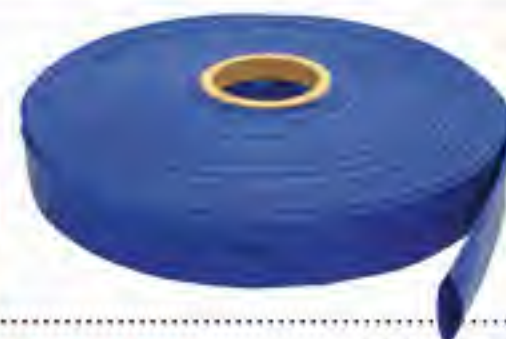

Blue Stripe® Oval Hose

Blue Stripe® Oval Hose is a lightweight economical tubing made from premium grade polyethylene. Can be punched. Used with insert fittings and clamps.



Item #	Description	Max PSI	Roll Wt.	Price
FPT1515	1½" x 150' Oval Hose	21 PSI	16 Lbs.	\$41.00
FPT2015	2" x 150' Oval Hose	21 PSI	24 Lbs.	\$47.50

Black Poly Pipe

This semi-rigid black utility poly tubing is useful for underground, well, or high pressure applications. Not punchable.



Item #	Description	PSI Rating	Price	Ship Via
11473	¾" x 100'	100 PSI	\$20.00	Ground
11474	1" x 100'	100 PSI	\$24.00	Freight
10178	1" x 300'	100 PSI	\$69.00	Freight

Other sizes and PSI ratings available, order 1-2 weeks in advance. Call for pricing.

Toro® Aqua-Traxx® Drip Tape

Typically used as a single year alternative to Blueline (see below), but isn't pressure compensating. Engineering-grade virgin resins and seamless construction add durability. The PBX Advantage increases durability, clog resistance and uniformity to set Aqua-Traxx apart from lesser drip tapes. For other sizes, spacings, and thicknesses contact: Nolt's Produce Supplies (717.656.9764)

Item #	Description	Spacing	Flow/100'	Flow/Emitter	Price	10+
11475	Aqua-Traxx® 10 mil, 6,000 ft.	18"	0.38 GPM	0.34 GPH	\$150.00	\$145.00
11476	Aqua-Traxx® 10 mil, 6,000 ft.	24"	0.28 GPM	0.34 GPH	\$150.00	\$145.00
11477	Aqua-Traxx® 10 mil, 6,000 ft.	36"	0.29 GPM	0.53 GPH	\$150.00	\$145.00



BlueLine® PC Pressure Compensating Dripline

18MM (¾") Orchard Tubing with Built-In Emitters

Features a unique, built-in flow regulated emitter, providing a constant discharge over a pressure range of 15-60 PSI. The emitter is inseparably welded to the inside wall of the tubing as it is extruded in the manufacturing process. Emitters are factory installed at pre-determined intervals. This one-piece construction prevents damage and loss of drippers, eliminates hole punching and handling damage, reduces installation costs.

BlueLine™ PC may be hung on a wire, laid on the surface or buried. Typically used in orchards, vineyards, over top of containers/mum pots, nurseries, or buried in fields for subsurface applications. **Stock Flow: 0.53 GPH per emitter.**

Item #	Description	Emitter Spacing	Price
DRP1812	18 MM (¾") x 1000'	12" spacing	\$160.00
DRP1818	18 MM (¾") x 1000'	18" spacing	\$135.00
DRP1824	18 MM (¾") x 1000'	24" spacing	\$120.00
DRP1830	18 MM (¾") x 1000'	30" spacing	\$115.00
DRP1836	18 MM (¾") x 1000'	36" spacing	\$110.00
DRP16	Plastic Stake to secure ½" tubing		\$0.22

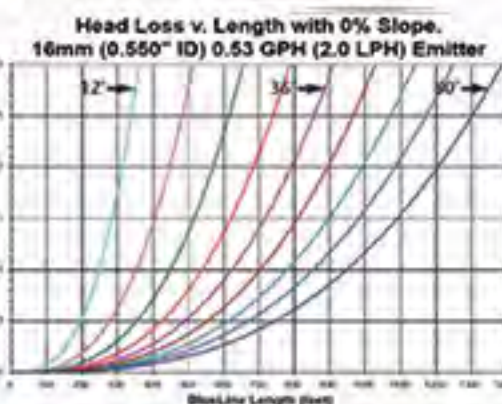

Raised inlets ensure that sediment deposits at the bottom of the tube do not enter the emitter.



Streamlined nature of the emitter encourages debris to pass by rather than enter the inlets.

Blue Stripe® Orchard Tubing

This lightweight polyethylene tubing is punchable and is often used for a lateral distribution & supply hose for on-line drippers, weighted drip tubes, micro-sprinklers and can be used as a headline for small drip tape systems.



Item #	Description	Max PSI	Roll Wt.	Price
BPT0051	½" x 100' Orchard Tubing	68 PSI	5 Lbs.	\$14.50
BPT0055	½" x 500' Orchard Tubing	68 PSI	22 Lbs.	\$39.00
BPT0059	½" x 1,000' Orchard Tubing	68 PSI	44 Lbs.	\$78.00
DRP16	Plastic Stake to secure ½" tubing	-	-	\$0.22
BPT0071	¾" x 100' Orchard Tubing	54 PSI	8 Lbs.	\$19.00
BPT0075	¾" x 500' Orchard Tubing	54 PSI	36 Lbs.	\$57.00
BPT0102	1" x 250' Orchard Tubing	53 PSI	24 Lbs.	\$50.00

White Orchard Tubing

White exterior, which reflects the sun and keeps the water cooler.

Item #	Description	Max PSI	Roll Wt.	Price
WPT0055	½" x 500' Orchard Tubing	68 PSI	22 Lbs.	\$57.00
WPT0075	¾" x 500' Orchard Tubing	54 PSI	36 Lbs.	\$76.00

PC Anti Drain Drippers

These can be punched into orchard tubing and are used in vineyards, orchards, as well as nurseries and greenhouses. Anti-drain and pressure compensating.

Operating Pressure: 15–60 PSI.



Item #	Description	Price	500+
12478	Blue, 0.5 GPH w/Nipple for Spiders	\$0.25	\$0.22
10679	Gray, 1.0 GPH w/Nipple for Spiders	\$0.25	\$0.22
11846	Red, 2.1 GPH w/Nipple for Spiders	\$0.25	\$0.22
NDT005	WPJC Netafim Red, 0.5 GPH w/Barb	\$0.32	\$0.29
NDT010	WPJC Netafim Grey, 1.0 GPH w/Barb	\$0.32	\$0.29

White Spider Assemblies

Multi-outlet device for PCD drippers.

These four outlet assemblies are commonly used for mums and other potted plants. They have straight stakes which allows for easy removal from established plants. Use with above PCD drippers.



Item #	Description	Pack of 10	Case of 100
12479	Spider, 4 x 18" tubes	\$9.60	\$86.00
12480	Spider, 4 x 24" tubes	\$9.90	\$89.00
12481	Spider, 4 x 30" tubes	\$10.40	\$93.00
12482	Spider, 4 x 36" tubes	\$10.80	\$97.00

Spider Components

Make your spiders to water anywhere from 1 to 6 pots per dripper using 1/8" spaghetti tubing (below).



Tees, crosses, and adapters can be combined.

Item #	Description	1-99	100+
12897	Single Outlet Adapter	\$0.07	\$0.06
12899	Two Outlet Tee	\$0.09	\$0.07
NGEFM2	Two Outlet Cross	\$0.09	\$0.07
12759	Four Outlet Cross	\$0.14	\$0.12
NMD82	Dripper Stake, Elbowed	\$0.12	\$0.11
NMD80	Dripper Stake, Straight	\$0.10	\$0.09

Spaghetti Tubing

Item #	Description	Dimensions	Price
12837	Black 1/8" x 100'	0.187" OD x 0.118" ID	\$7.00
12833	Black 1/8" x 1000'	0.196" OD x 0.126" ID	\$37.50
WVT00121	White 1/8" x 1000'	0.196" OD x 0.126" ID	\$48.00
BVT0018	Black 3/16" x 100'	0.250" OD x 0.170" ID	\$7.50
BVT00181	Black 3/16" x 1000'		

Barb to Barb Couplings



Item #	Description	1-99	100+
TB 125	1/8" Barb Couplings	\$0.10	\$0.08
TB 170	3/16" Barb Couplings	\$0.10	\$0.08

Netafim™ Pot Drippers



SlimLine EZ Close Assemblies combines the benefits of:

- One-hand, EZ close shut-off of individual baskets – prevents water and fertilizer spillage and waste
- Snag-free slim design for easy retrieval from plants at harvest – no more lost weights
- 94% flow uniformity – from the first basket to the last

For 1 gph or custom length:

Assemble your own using NDT00 weight, NDT00121 tubing and NDT005 or



Item #	Description	25-475	500+
NDT24	Pot Dripper, 24" tube, 1/2 gph	\$0.76	\$0.72
12910	Pot Dripper, 36" tube, 1/2 gph	\$0.81	\$0.77
NDT48	Pot Dripper, 48" tube, 1/2 gph	\$1.04	\$0.99
NDT001	Slimline Plastic Weight/Shutoff	\$0.38	\$0.34

JAIN On/Off Twist Weights

These plastic on/off twist weights come with 0.060" ID tubing. Not pressure compensating, used for fast watering. Max of 50' row lengths when using 1/2" supply line.



Item #	Description	1-99	100+	500+
13086	On/Off Twist Weight, 24" tube	\$0.63	\$0.58	\$0.56
COT36	On/Off Twist Weight, 36" tube	\$0.65	\$0.60	\$0.58
COT48	On/Off Twist Weight, 48" tube	\$0.67	\$0.62	\$0.60

Pressure Compensating, 0.5 GPH

Same as above but with PC 0.5 GPH MicroFlappers® elbow. Uniform flow regardless of pressure, elevation, and length of supply line. Operating Pressure: 15–45 PSI.

Item #	Description	50-450	500+
COT136	PC On/Off Twist Weight, 36" tube	\$0.95	\$0.92

You can assemble your own by using COT24, COT36, or COT48 drippers (above), COT905 emitters (below) & 1.5" length of BVT0012 0.118" ID tubing (previous column).

Item #	Description	1-99	100+
COT905	0.5 GPH Emitter, 90° Ell	\$0.25	\$0.22

Pot Spray Stakes

Provides consistent flow and 160° spray pattern. Unique positioning arrow for indicator of flow.

Use 1/8" or 3/16" couplings & spaghetti tubing.



Item #	Description	1-99	100+
PSS05	Pot Spray Stake, 6.4 GPH, Black	\$0.15	\$0.14
PSS10	Pot Spray Stake, 10.5 GPH, Blue	\$0.15	\$0.14
PSS15	Pot Spray Stake, 16.0 GPH, Green	\$0.15	\$0.14

Goof Plugs

Plugs holes 1/8" – 1/4" in diameter in poly tubing.



Item #	Description	Price
5150	Goof Plugs. Pack of 10	\$0.50

NaanDan Jain® Modular Group Performance Micro-Sprinklers and Sprayers

Sprinkler Selection Chart • All sprinklers calculated at 3' spacing.

Spreader or Spinner	Flow Rate	Height	Bench or Bed Width														
			4'	5'	6'	7'	8'	10'	12'	14'	15'	16'	18'	20'	22'	24'	
Yellow Flat	Low	2'	G	O	O	O	-	-	-	-	-	-	-	-	-	-	-
		4'	-	-	O	O	O	-	-	-	-	-	-	-	-	-	-
	High	2'	Y	Y	Y	B	-	-	-	-	-	-	-	-	-	-	-
		4'	-	-	B	B	-	-	-	-	-	-	-	-	-	-	-
Green Kiwi	Low	4'	-	-	-	-	-	-	-	O	O	O	O	G	-	-	-
		6'	-	-	-	-	-	-	-	O	O	O	O	O	O	-	-
	High	4'	-	-	-	-	-	-	-	B	B	B	B	-	-	-	-
		6'	-	-	-	-	-	-	-	B	B	B	B	B	-	-	-
Black Round	Low	4'	-	-	-	-	-	O	O	-	-	-	-	-	-	-	-
		6'	-	-	-	-	G	O	O	-	-	-	-	-	-	-	-
	High	4'	-	-	-	-	Y	Y	Y	-	-	-	-	-	-	-	-
		6'	-	-	-	-	Y	Y	Y	Y	-	-	-	-	-	-	-
Black Single Wing	Low	10"	-	-	-	-	-	O	O	O	O	-	-	-	-	-	-
	High	10"	-	-	-	-	-	-	B	B	B	B	-	-	-	-	-
Orange Oblong	Low	10"	-	-	-	-	-	-	-	-	-	-	Gy	Gy	Gy	G	-
	High	10"	-	-	-	-	-	-	-	-	-	-	-	O	O	O	O

NAANDANJAIN

A JAIN IRRIGATION COMPANY

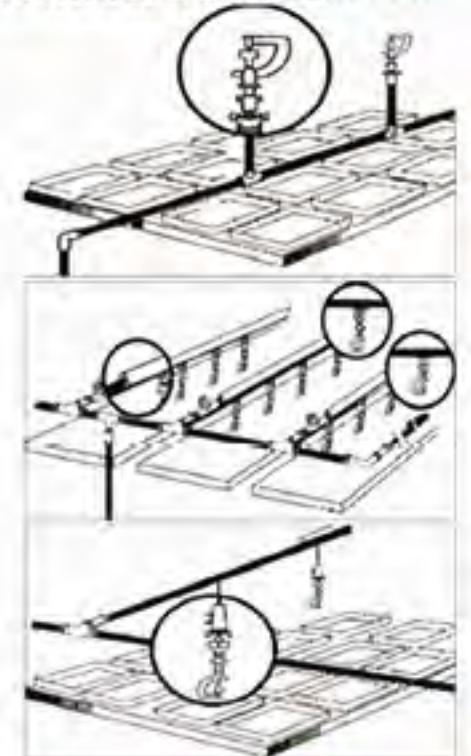

Greenhouse Hanging Assembly Includes: • Nozzle, • Spinner, • Bridge, • LPD, • Stabilized Hanging Tube Length Price 24" \$3.72 36" \$3.82 48" \$3.92	Bridge Assembly (Butterfly) Includes: • Nozzle, • Spinner, • Bridge, • Butterfly Price \$1.57	Upright Assembly Includes: • Nozzle, • Spinner, • Bridge, • Stabilized Hanging Tube • 12" Stake Tube Length Price 24" \$3.02 36" \$3.12 48" \$3.22	Bridge Assembly Includes: • Nozzle, • Spinner, • Bridge Price \$1.17
Nozzle & Anti-mist Specify Color Item # Description Price NMS0* Nozzle \$0.25 NMS6* Antimist \$0.28	Spreaders Item # Size Price NMS5* Specify Color \$0.32	Spinners Item # Size Price NMS4* Specify Color \$0.32	Bridge Item # Description Price NMS3 Bridge \$0.60
Stabilized Hanging Tubes, (Tube, stabilizer and butterfly mount) Plastic Stakes, 12" (See Upright Assembly for use illustration) Item # Size Price NMS124 24" Tube \$1.25 NMS136 36" Tube \$1.35 NMS148 48" Tube \$1.45 NMS314 12" Stake \$0.60	Butterfly Mount Item # Description Price NMS33 Butterfly Mount \$0.40	1/2" Male Threaded Base Item # Description Price NMS35 1/2" Male Base \$0.70	Agri-Connector 1/2" FPT x 3/16" Barb Item # Description Price NMS1 Agri-Connector \$0.75
LPD (Anti-Drip) Opens at 20 PSI Closes at 9 PSI Item # Size Price NMS2 LPD (Anti-Drain) \$1.30	3/16" Barb Connector Item # Size Price TB 170 3/16" Barb \$0.10	3/16" Black Vinyl Tubing To make custom length tubes. Item # Description Price BVT0018 3/16" x 100' \$7.50 BVT00181 3/16" x 1000' \$52.00	

GREENHOUSE SUPPLY

NaanDan Jain® Foggers/Misters

Performance Micro-Sprinklers and Sprayers

Commonly used for propagation, cooling and humidification in greenhouses. Contact us for design information. **Recommended Pressure: 35 – 45 PSI.** For mounting/hanging options see Modular Group Sprinklers/Sprayers on page 33.



Installation Recommendations:

One fogger should be used for every 2.5 square feet. The cross with four foggers will cover an area up to 10 square feet (3 – 4 feet wide).

Foggers should be installed at a height of 3 – 5 feet above the propagation material.

The spacing between the fogger assemblies should be 3 feet.

Multiple flow rates available for different precipitation rates.

3' – 4' Bench: One line above the center.

6' – 7' Bench: Two lines with crosses are required.

To prevent dry edges on a single bench (no other benches within 2') the cross should not be further than 1' from the edge. In some instances two lines may be required on a 4' bench.

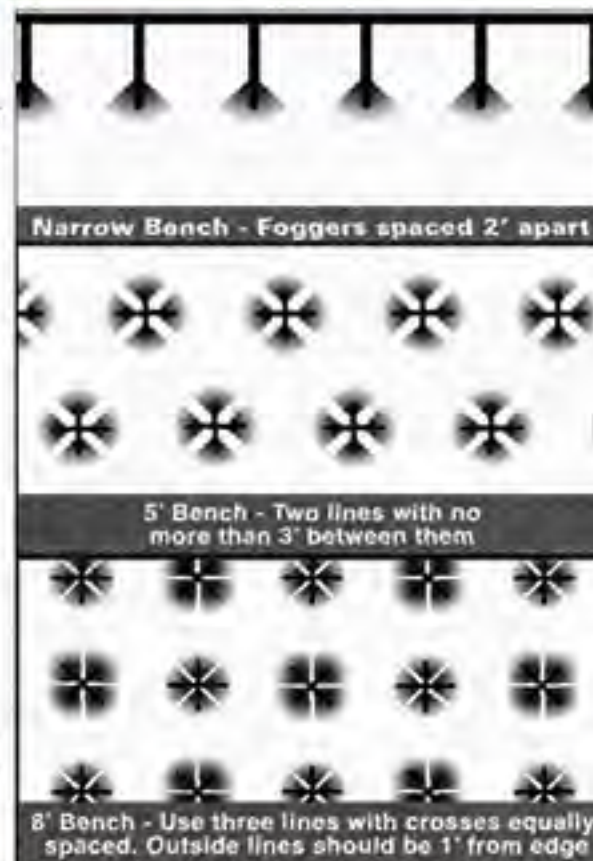

Item #	Description	Price
NMF018	Blue Fogger, 1.8 GPH	\$1.00
NMF036	Orange Fogger, 3.6 GPH	\$1.00
NMF054	Red Fogger, 5.4 GPH	\$1.00
NMF072	Black Foggers, 7.2 GPH	\$1.00
NMF2	LPD (Anti-Drip), Opens at 55 PSI, Closes 35 PSI	\$1.30
NMFX	4 Way Cross	\$1.35
NMFT	2 Way Tee	\$1.30
NMF45	45° Angle Adapter	\$0.45
NMFP	Plug	\$0.40

Senninger® Mini-Wobblers

Low-angle trajectory & good droplet size reduce wind drift and distortion of the spray pattern. Space & stagger these sprinklers at 30% less than listed diameter for uniform coverage.



Operating Pressures: 15-25 PSI (Upright); 20-25 PSI (Inverted).
Connections: 1/2" MPT.

mini-Wobbler, Upright

Diameter calculated at 1.5' height.

Nozzle Color	Light Blue		Beige		Gold		Lime		Lavender	
	Nozzle Size	#4 1/16"	#5 5/64"	#6 3/32"	#7 7/64"	#8 1/8"	Nozzle PSI	GPM	DIA.	GPM
15	0.42	26.5	0.64	31.0	0.95	33.0	1.30	35.0	1.67	35.5
20	0.50	28.0	0.75	33.5	1.10	36.0	1.51	37.5	1.95	38.5
25	0.56	28.0	0.84	35.0	1.25	37.0	1.69	38.5	2.18	43.0

i-mini-Wobbler, Inverted

Diameter calculated at 6' height.

Nozzle Color	Beige		Gold				
	Nozzle Size	#5 5/64"	#6 3/32"	Nozzle PSI	GPM	DIA.	GPM
20	0.75	32.0	1.10	34.0			
25	0.84	32.5	1.25	34.5			

Riser Assembly 1/2" FPT x barb. Use DTFAP07 punch. Use 1/2" or 3/4" pipe or 5/16" rod for stake.

Item #	Description	Price
13173	W/36" tube	\$3.70
WOR148	W/48" tube	\$3.80

Senninger® Xcel-Wobblers

The Xcel-Wobbler uses Senninger's off-center rotary-action technology. It provides an extremely uniform and instantaneous application pattern over a large area at lower pressures, and with very low evaporative loss and wind drift. Wobblers are designed for nursery irrigation and frost protection. Wobblers installed in test bed withstood winds up to 25 MPH and temperatures as low as 18°. They are an excellent sprinkler for small diameters from 35 to 56 feet. The Xcel has less vibration than earlier models. **Connection:** 1/2" MPT.

Operating Pressures: 10 – 25 PSI.

Space & stagger these sprinklers at 30% less than listed dia. for uniform coverage.



Diameter at 1.5' height.

Nozzle Color	Gold		Lavender		Turquoise		Red		Blue		Orange	
	Nozzle Size	#6 3/32"	#8 1/8"	#10 5/32"	#12 3/16"	#14 7/32"	#16 1/4"	Nozzle PSI	GPM	DIA.	GPM	DIA.
10	0.78	36.5	1.40	42.0	2.22	44.5	3.23	46.0	4.40	47.0	5.61	48.0
15	0.95	41.0	1.71	46.5	2.72	49.0	3.96	50.5	5.39	51.0	7.88	52.5
20	1.10	45.0	1.98	47.0	3.14	50.5	4.57	52.0	6.23	53.0	9.63	55.0
25	1.23	46.0	2.21	51.5	3.51	53.5	5.11	54.5	6.97	55.5	11.01	56.5

Upright mini-Wobbler®

Item #	Description	Price
13127	Upright mini-Wobbler, #4 Blue Nozzle	\$3.95
13128	Upright mini-Wobbler, #5 Beige Nozzle	\$3.95
13129	Upright mini-Wobbler, #6 Gold Nozzle	\$3.95
13130	Upright mini-Wobbler, #7 Lime Nozzle	\$3.95
13132	Upright mini-Wobbler, #8 Lavender Nozzle	\$3.95

Inverted mini-Wobbler®:

WOI05	Inverted mini-Wobbler, #5 Beige Nozzle	\$3.95
WOI06	Inverted mini-Wobbler, #6 Gold Nozzle	\$3.95

Replacement Nozzles:

WOT04	#4 Blue Nozzle for mini-Wobbler	\$0.50
WOT05	#5 Beige Nozzle for mini-Wobbler	\$0.50
WOT06	#6 Gold Nozzle for mini-Wobbler	\$0.50
WOT07	#7 Lime Nozzle for mini-Wobbler	\$0.50
WOT08	#8 Lavender Nozzle for mini-Wobbler	\$0.50

Item #	Description	Price
4850	Xcel-Wobbler, #6 Gold Nozzle	\$7.50
4962	Xcel-Wobbler, #8 Lavender Nozzle	\$7.50
13170	Xcel-Wobbler, #10 Turquoise Nozzle	\$7.50
WOBX12	Xcel-Wobbler, #12 Red Nozzle	\$7.50

Replacement Nozzle:

WOB06	#6 Gold Nozzle for Xcel-Wobbler	\$0.50
WOB08	#8 Lavender Nozzle for Xcel-Wobbler	\$0.50
4963	#10 Turquoise Nozzle for Xcel-Wobbler	\$0.50
4964	#12 Red Nozzle for Xcel-Wobbler	\$0.50
WOB14	#14 Blue Nozzle for Xcel-Wobbler	\$0.50
120 24	#16 Orange Nozzle for Xcel-Wobbler	\$0.50

Black Woven Ground Cover

This UV stabilized, woven cloth is extremely strong and far superior to sheet plastic. This woven polypropylene fabric that is permeable to air and water, yet blocks weeds effectively. **3.2 - 3.3 oz./sq. yd. with stripes every foot.**

Item #	Size	1-5	6+	Weight
3794	3' x 300'	\$45.95	\$42.95	25 Lbs.
3698	4' x 300'	\$61.95	\$56.95	33 Lbs.
2964	6' x 300'	\$92.95	\$83.95	50 Lbs.
2996	10.5' x 300'	\$158.95	\$143.95	87 Lbs.
2765	12.5' x 300'	\$192.95	\$175.95	104 Lbs.
2766	15.5' x 300'	\$238.95	\$217.95	130 Lbs.

White Woven Ground Cover

Same as the black ground cover above except the fabric is white with black stripes every foot. **3.2 oz./sq. yd.**

Item #	Size	Price	Weight
11314	3' x 300'	\$62.95	25 Lbs.
11315	6' x 300'	\$118.95	50 Lbs.
11316	12' x 300'	\$236.95	104 Lbs.
11317	15' x 300'	\$294.95	130 Lbs.

Steel Sod Staples



Item #	Description	Price	5+
3640	HD Staples, 8" x 1", 8 gauge, 500/box	\$39.95	\$38.95
10298	Staples, 6" x 1", 11 gauge, 1,000/box	\$35.95	\$33.95

Black Knitted Shade Cloth, 50% Shade



In Stock. Made from 100% UV stabilized polyethylene with a lock stitch construction that keeps edges from unraveling.

The material to be cut to exact size on job site with household scissors. "Clip-its" to hold material are supplied at no extra charge, enough for 4' spacing on length of both sides. *Shipping Weight: 40 lbs/100'.*

Item #	Description	1 - 94'	95'+
12303	26' Shade Cloth, 50% Black Knitted	\$3.95	\$3.40
12487	34' Shade Cloth, 50% Black Knitted	\$4.95	\$4.30
4277	Plastic Clip-its (folds & clamps to secure)	\$0.29	-

Custom sizes and other shade percentages are also available. Allow two weeks for delivery on custom orders. Call us for pricing. Available shade

White Thermal Blanket

A white, non-woven, needle punched polypropylene fabric. Provides 10°+ frost protection, but transmits light, mostly used to overwinter or cover dormant nursery stock. **2.5 oz./sq. Yd.**

Item #	Description	Price
12484	White Thermal Blanket, 6' x 250'	\$115.95
12485	White Thermal Blanket, 12' x 250'	\$228.95
12486	White Thermal Blanket, 15' x 250'	\$282.95



Tufflite® Greenhouse Plastic

Manufactured by Berry Plastics, Tufflite™ products offer high clarity to allow the most light possible. They also feature tri-layer extrusion and dust resistance.



Tufflite IV™ is a high clarity, 4 year, 6 mil, high-quality greenhouse covering.

Tufflite IV™, Clear, 6 mil, 4 year					
Item #	Size	Price	Item #	Size	Price
3464	14' x 100'	\$122.95			
3187	20' x 100'	\$175.95			
4452	24' x 100'	\$210.95	4391	24' x 150'	\$316.95
4350	28' x 100'	\$246.95			
3463	32' x 100'	\$281.95	11502	32' x 150'	\$422.95
3186	36' x 110'	\$348.95	11503	36' x 150'	\$474.95
2658	40' x 100'	\$351.95	4265	40' x 150'	\$527.95
4127	42' x 100'	\$359.95	10921	42' x 150'	\$524.95
2660	48' x 100'	\$422.95	4240	48' x 150'	\$633.95
10339	50' x 100'	\$439.95	10340	50' x 150'	\$659.95
11501	56' x 100'	\$492.95	11504	56' x 150'	\$738.95

Tufflite Infrared™ is a 4 year, 6 mil, energy saving greenhouse covering. Features Drip-Less™ technology, along with an additive that retains infrared waves, which improves nighttime heat retention. Also is light diffusing – reduces shadows. Use for the bottom layer in double layer

Tufflite Infrared™, Clear, 6 mil, 4 year					
Item #	Size	Price	Item #	Size	Price
4454	24' x 100'	\$242.95			
4491	28' x 100'	\$283.95			
3188	32' x 100'	\$323.95	11508	32' x 150'	\$485.95
111505	36' x 110'	\$400.95	11509	36' x 150'	\$546.95
3184	40' x 100'	\$404.95	4264	40' x 150'	\$606.95
10192	42' x 100'	\$424.95	11510	42' x 150'	\$637.95
2755	48' x 100'	\$485.95	4239	48' x 150'	\$728.95
10506	50' x 100'	\$505.95	11511	50' x 150'	\$758.95
11507	56' x 100'	\$566.95	11512	56' x 150'	\$849.95

Tufflite Nursery Clear™

Tufflite Nursery Clear™, 4 mil, 1 year					
Item #	Size	Price	Item #	Size	Price
10777	24' x 100'	\$101.95	3642	24' x 150'	\$152.95
2757	32' x 100'	\$135.95	12440	32' x 150'	\$202.95
2756	40' x 100'	\$169.95	4442	40' x 150'	\$256.95

Tufflite White Copoly, 70% Shade

A 4 mil, 1 season, greenhouse covering. Can be used for over-wintering, often used for dormant stock or on storage structures.

Tufflite White Copoly, 4 mil, 1 year					
Item #	Size	Price	Item #	Size	Price
11513	24' x 100'	\$101.95	11515	24' x 150'	\$152.95
4951	32' x 100'	\$135.95	11516	32' x 150'	\$202.95
11514	40' x 100'	\$169.95	11517	40' x 150'	\$256.95

KlerksKoolLite Plus



This 4 year, 6 mil, UV stabilized covering allows 84% light transmission, yet lowers greenhouse air temperature by 10 degrees compared to traditional greenhouse films. Also features light diffusion (53%), 2 sided anti-condensate, and IR additives that re-radiate nighttime infrared heat.

KoolLite Plus, 6 mil, 4 year					
Item #	Size	Price	Item #	Size	Price
11518	32' x 100'	\$422.95	11522	32' x 150'	\$633.95
11519	36' x 100'	\$474.95	11523	36' x 150'	\$712.50
11520	42' x 100'	\$554.95	11524	42' x 150'	\$831.95
11521	48' x 100'	\$633.95	11525	48' x 150'	\$950.95

All Klerks greenhouse film also available. Allow 3 - 4 weeks.

Poly Patch Greenhouse Tape

A rugged patching tape for preventive maintenance in areas of extra stress and is perfect for mending greenhouse rips and tears. Clear, polyethylene tape with a medium tack acrylic-based adhesive with a white poly coated release



Item #	Description	Price
12491	Poly Patch Tape, 2" x 48'	\$7.95
2770	Poly Patch Tape, 4" x 48'	\$14.95
2769	Poly Patch Tape, 6" x 48'	\$22.95

Inflation Blowers

For inflating double layered film on greenhouses.

120Vac. Pre wired with 8 ft cord.



Item #	Description	Price
3465	3 Bolt Blower, 60 CFM, 0.15A (18 W)	\$61.95
3466	3 Bolt Blower Mounting Kit	\$18.95
2921	4 Bolt Blower, 148 CFM, 0.5A (60 W)	\$74.95
3467	4 Bolt Blower Mounting Kit	\$18.95

Air Jumper Tube

Air jumper tubes with twist coupling ends. Used to jump air from main inflated part to side curtains and endwalls.



Item #	Description	Price
4262	24" Air Jumper Tube	\$16.95
4263	48" Air Jumper Tube	\$17.95

Battery Powered Inflation Fan

Brushless 12VDC, 0.22A (2.64 W) fan. Inflation unit includes a wirelock frame and clamps to connect to battery. 77 CFM.

Item #	Description	Price
11526	12V Muffin Fan Inflation Unit	\$76.95
11527	Replacement 12V Muffin Fan	\$28.95

Greenhouse Spacer Blocks

These spacer blocks are used to create an air layer between two layers of poly without the need for an inflation blower or electricity. They are commonly used where electricity is unavailable.



Item #	Description	Price	100+
11489	Greenhouse Spacer Block	\$5.95	\$5.70

White Felt Tape

White, 1/8" thick felt with an acrylic-based adhesive. Use to cover sharp edges or rough surfaces. Protects greenhouse hoops and components from wearing and tearing greenhouse film.

Item #	Description	Price
11490	White Felt Tape, 1 1/2" x 48'	\$18.95

White Vinyl Batten Tape

For securing plastic film to end walls, wood frame greenhouses, cold frames, etc. Just staple every 3-4" holding tape tight. 3/4" wide x 1/32" thick, 500 ft roll.

Item #	Description	Price
4773	3/4" x 500' Batten Tape	\$34.95

WireLock Poly Fastener

Poly fastener system that also works with shade cloth, insect and bird netting, etc. ZigZag wires lock the material in the WireLock channel. (ZigZag wire sold separately, see below). Can be used to splice poly. Can be formed to the top of curved bows. Holds to 4 layers poly and 2 layers ZigZag wire.



Item #	Description	Price	20+	60+
4213	8' Aluminum Single WireLock	\$6.95	\$6.45	\$5.25
4128	12' Aluminum Single WireLock	\$9.95	\$8.95	\$7.75

ZigZag Wire

For use with wirelock poly fasteners. Our Zig Zag wire is made from .085" diameter heavy duty, stainless steel spring wire double-tempered to allow for a better return to original shape.

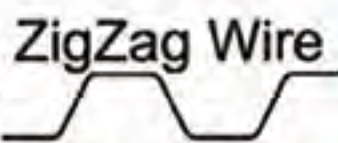

Item #	Description	Price	50/Bndl (200')
4129	4' ZigZag Wire	\$0.95	\$0.85ea=\$42.50

Double WireLock

Commonly used at the top of roll up sides which eliminates the need to run a supporting board vs single WireLock. Order ZigZag wire separately.



Item #	Description	Price	10+
10207	8' Aluminum Double WireLock	\$16.95	\$15.45
GFA1080	12' Aluminum Double WireLock	\$24.00	\$21.80

Polycarbonate Sheeting

Clear twin-wall 8 MM polycarbonate sheeting. The perfect glazing choice for any greenhouse covering, translates its many unique features into cost saving benefits. Heavy Gauge: Increased strength. Improved hail protection. Anti Fog: prevents condensation buildup. Improved light transmission 10 year warranty. **Install with UV protected side toward exterior!**



Item #	Description	Price	10+
4615	4' x 8' Polycarbonate Sheet, 8 MM	\$46.50	\$45.00
11491	4' x 10' Polycarbonate Sheet, 8 MM	\$57.00	\$55.00
5083	4' x 12' Polycarbonate Sheet, 8 MM	\$67.40	\$65.00
11492	4' x 14' Polycarbonate Sheet, 8 MM	\$77.80	\$75.00

We can custom order any length sheets (maximum 48').

Aluminum Extrusions for Polycarbonate

For 8 MM Polycarbonate sheeting. Double H is used to join two pieces. Single h is used to hold down edge or cover end.



Item #	Description	Price	20+
10493	12' Double H Extrusion	\$12.95	\$12.15
10494	12' Single h Extrusion	\$10.95	\$10.40

Tape and Washers for Polycarbonate

10145 is a 1" neoprene/metal bonded washer. Use with fasteners when securing polycarbonate. Aluminum tape can be used to close the top of polycarbonate. Vent tape is used to cover bottom of polycarbonate keeps bugs and dirt out while draining water and letting air in.



POL010

POLA

POLV

Item #	Description	Price
10145	1" Metal/Neoprene Washers, 100/bag	\$8.50
11495	2" x 150' Aluminum Foil Tape	\$10.95
11496	1 1/2" x 108' Vent Tape	\$27.95

End Bow WireLock

Use on gable end arch (bends to fit curved arch). Attach to top of arch with #12 x 1" Tek screws every 12" (see page 39). Cut polycarbonate to fit curve and slide underneath flange.



Item #	Description	Price
11497	12' End Bow Wirelock	\$16.95

Slide Clamps

This 3" wide pipe strap, no holes, is used for attaching double WireLock to greenhouse arches.



Item #	Description	Price
11498	1 1/2" Slide Clamp fits 1.315" OD pipe	\$1.95
11499	1 5/8" Slide Clamp fits 1.66" OD pipe	\$1.95
11500	2" Slide Clamp fits 1.9" OD pipe	\$1.95

Stainless Steel Screws

Tek Screws Hex head. Self drilling into metal.

Item #	Description	Bag Qty	Price	5+
12492	#10 x 3/4" SS Tek Screw	100/Bag	\$8.80	\$8.00
11594	#12 x 1" SS Tek Screw	100/Bag	\$12.20	\$11.00
11595	#12 x 1 1/2" SS Tek Screw	100/Bag	\$16.30	\$15.00
11596	5/16" Hex Driver Bit for above	-	\$2.00	-
11597	#14 x 1" SS Tek Screw	50/Bag	\$10.00	\$9.00
11598	3/8" Hex Driver Bit for above	-	\$2.50	-

Tek Screws Philips pan head. Self drilling through aluminum extrusions into wood.

Item #	Description	Box Qty	Price	5+
12513	#10 x 1 1/2" Philips Tek Screw	100/Box	\$15.50	\$14.00

Wood Screws with Washer 1/4" Hex head.

Item #	Description	Bag Qty	Price	5+
11600	#9 X 1 1/2" Wood Screw	250/Bag	\$30.00	\$27.00
11601	1/4" Hex Driver Bit for above	-	\$2.00	-

Deck Screws Star drive – no slipping. Bit included in each box.

Item #	Description	1 Lb. Box	Price	5+
11602	#9 x 1 1/2" Deck Screw	167 pieces	\$16.00	\$14.75
11603	#9 x 2" Deck Screw	124 pieces	\$16.00	\$14.75
11604	#9 x 2 1/2" Deck Screw	86 pieces	\$16.00	\$14.75

Cross Connectors

Don't Drill! Cross-Connect! Unique, 2-piece aluminum connector retains 100% of your frame's strength.



Item #	Description	Price	50+
10003	Connects 1.315" to 1.315" pipe	\$1.90	\$1.70
11579	Connects 1.315" to 1.66" pipe	\$2.00	\$1.80
11580	Connects 1.315" to 1.9" pipe	\$2.15	\$1.95

Metal Pipe Straps

These heavy-duty, 3 hole metal pipe straps are used to fasten purlins, windbraces, baseboards, etc. Has a predrilled hole on the round part of the strap for a third tek screw to keep it from sliding.



Item #	Description	Price	250+
10008	1" Pipe Strap, fits 1.315" OD pipe	\$0.45	\$0.40
10004	1 1/4" Pipe Strap, fits 1.66" OD pipe	\$0.50	\$0.45
11581	1 1/2" Pipe Strap, fits 1.9" OD pipe	\$0.55	\$0.48
GPS020	2" Pipe Strap, fits 2.375" OD pipe	\$0.60	\$0.55

Black Nylon Cable Ties, UV Treated

Item #	Length	Tensile Strength	Max Bundle Dia.	Bag Qty	Price
BCT04	4"	18 Lbs.	3/4"	100/Bag	\$2.50
14453	8"	40 Lbs.	2"	100/Bag	\$4.50
BCT11	11"	50 Lbs.	3"	100/Bag	\$6.00
BCT14	14"	120 Lbs.	4"	100/Bag	\$9.00

Gatorshield® Square Tubing

This heavy-duty 1 3/4" GatorShield® galvanized steel square tubing has Allied's superior, triple-layer rust and corrosion resistant product protection. Uses include: framing greenhouse gable ends, greenhouse benches, doors, etc.



Item #	Description	Price	25+
11658	1 3/4" Square Tubing, 13' 4" long	\$34.50	\$33.00

Splicer for Square Tubing

Fits inside 1 3/4" square tubing. Secure with tek screws. 8" length.

Item #	Description	Price
11583	Coupler for 1 3/4" Square Tubing	\$1.85

Metal End Wall Angle

Ell for connecting square tubing at right angles. Angle is 1 1/2" x 2" with three holes for fasteners. Tek screws are the recommended fastener.

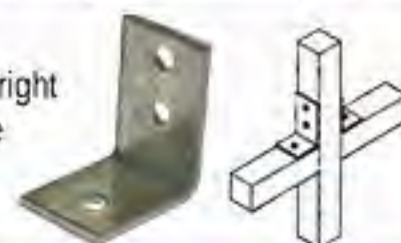

Item #	Description	Price	100+
11584	Metal End Wall Angle	\$0.60	\$0.50

Brace Bands

Item #	Description	Price
11585	1.315" Brace Band	\$0.55
11586	1.66" Brace Band	\$0.60
10164	1.9" Brace Band	\$0.70
GN 1	5/16" Galv. Nut	\$0.05
GCB015	5/16" x 1-1/2" Galv. Carriage Bolt	\$0.13



End Wall Framing Brackets

Used to attach end wall framing to the gable end arch. Works with any wood or metal square tubing end walls. Size indicates size of brace band, match to your arch size.



Item #	Description	Price
10005	1.315" End Wall Framing Bracket	\$2.90
11587	1.66" End Wall Framing Bracket	\$3.00
11588	1.9" End Wall Framing Bracket	\$3.00

Extension Hangers

Heavy-duty S-hooks

Made from 10 gauge galvanized steel, these S-hooks can hold up to 35 pounds. 1 3/4" hooks on each end.

Item #	Description	Price
11589	6" S-hooks, 100/Box	\$17.80
4899	12" S-hooks, 100/Box	\$21.70
11590	15" S-hooks, 100/Box	\$23.70
11591	18" S-hooks, 100/Box	\$25.50
10319	24" S-hooks, 100/Box	\$29.70
11592	30" S-hooks, 100/Box	\$33.60
4900	36" S-hooks, 100/Box	\$37.50

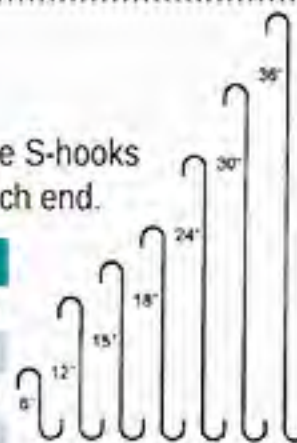

Greenhouse Roll Up Sides

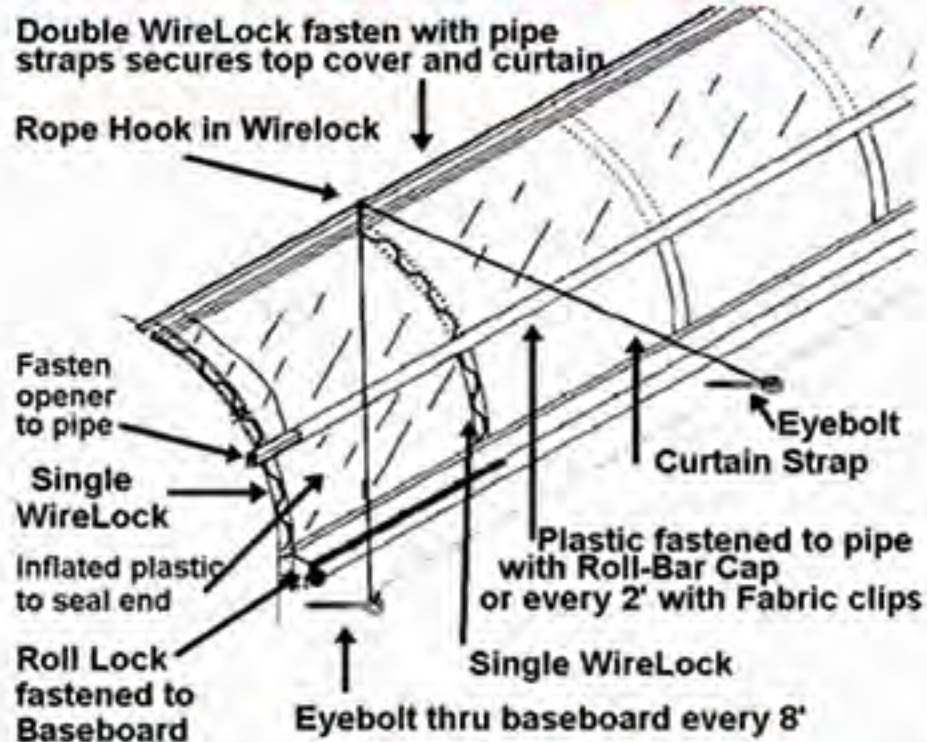

Use with Double WireLock & ZigZag Wire.

1.315" Galvanized Swedged Pipe, 17 ga.

For purlins or roll up pipe. 12' plus 3" swedge.

Item #	Description	Price	10+
3639	1.315" Purlin, 12' 3" length	\$11.95	\$11.45

Roll Bar Cap

Securely holds single or double layer plastic to 1.315" OD. roll pipe. Fasten with #12 x 1" Tek screws every 12"

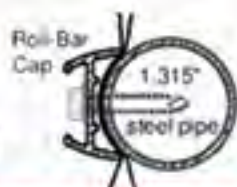

Item #	Description	Price	24+
10196	8' Roll Bar Cap	\$4.95	\$4.70

Aluminum Fabric Clips

Fastening plastic or shade cloth to pipe is a snap with fabric clips. Space every 2' on roll



Item #	Description	Price	100+
11569	3/4" Fabric Clip, fits 0.92" OD pipe	\$1.00	\$0.95
11570	1" Fabric Clip, fits 1.315" OD pipe	\$0.85	\$0.80
11571	1 1/4" Fabric Clip, fits 1.66" OD pipe	\$1.05	\$1.00

Side Clasp Roll Bar

Posi-Clasp's 2" OD aluminum Side Clasp Roll Bar is the "all-in-one" roll bar. This roll bar can be used on curtain systems up to 200'. Works great with Roll-Lock. The SCRBS uses Zig-Zag Wire (not included) to clasp one or two layers of curtain material into the built-in WireLock groove, allowing it to maintain its round shape as the curtain is rolled up.



Item #	Description	Price	8+
10994	12' Side-Clasp Roll Bar	\$28.95	\$27.95

Aluminum Roll-Lock

The Posi-Clasp Roll-Lock extrusion, creates a fully secured seal at the bottom of the roll up sides. Because of its superior seal it is recommended to use on heated structures. Enhances wind control and extends poly life. Splice plates are included.



Item #	Description	Price
GFA5RL	8' Aluminum Roll-Lock	\$27.25
GFA5RL1	12' Aluminum Roll-Lock	\$39.37

Roll Pipe Installation Aids

Hangers (RPHRL & RPH2x) make roll bar installation quicker, easier & more uniform. Pipe hanger sets uniformly support 96' feet of roll pipe during installation. Hangers can be moved along greenhouse as installation progresses. Roll pipe deflector is for 2" baseboard. Install when not using Roll-Lock to deflect roll pipe out over edge of baseboard.



Item #	Description	Price
11574	Roll Pipe Hanger, for over Roll-Lock, set of 9	\$37.95
11575	Roll Pipe Hanger, fits 2" baseboard, set of 9	\$19.95
11576	Roll Pipe Deflector, for 2" baseboard, set of 9 does 96'	\$19.95

Zinc Eye Bolts & Screws

Item #	Description	Price
10194	5/16" x 3" Eye Bolt, for baseboard w/o Roll-Lock	\$0.72
ZEB06003	3/8" x 6" Eye Bolt, for baseboard w/ Roll-Lock	\$1.12
ZES04003	5/16" x 4" Eye Screw, for baseboard w/o Roll-Lock	\$0.82

Curtain Rope & Rope Hooks

Black Braided Curtain Rope, 1/4", 100% polyester. Aluminum Rope Hook inserts into WireLock without fasteners. Open hook for 1/4"



Item #	Description	Price
10237	1/4" x 350' Black Curtain Rope	\$37.95
10193	Aluminum Rope Hook, Pack of 25	\$29.95

Curtain Strapping

Item #	Description	Price
11577	2" x 600' Black Curtain Strapping, UV resistant	\$36.95

Handheld Poly Sealer

Seal 2 layers of poly together at curtain ends to allow roll up sides to inflate. Required for automatic inflation of Roll Up/Lockdown Systems that use the Roll-Lock extrusion. Features: 6" sealing length with teflon coated jaws. Seals PE, PVC, Cello, Mylar, and more. 115 volt, 25 watt



Item #	Description	Price
11578	Handheld Poly Sealer, 6" jaws	116.95

Manual Gear Crank Operator Packages

5:1 Ratio, internal brake. Needs to be reached from the ground. Uses 1" OD guidepipe. Rolls up to 96'. Not for use with Roll Lock (use HD cranks).



Item #	Description	Price
10190	5:1 Gear Crank, fits 1.315" roll pipe	\$86.95
10191	6' Guidepipe & Hanging Hardware for GFAM04	\$19.95

7:1 Ratio, Heavy-duty, internal brake. Includes 24" crank handle. Rolls up to 120', works with Roll-Lock. Fits 1.315" guidepipe and roll pipe.



13:1 Ratio, Heavy-duty, internal brake. Includes 24" crank handle. Rolls up to 240', works with Roll-Lock. Fits 1.315" guidepipe and roll pipe.



11551

11548

Item #	Description	Price
4772	7:1 Gear Crank with 30" crank handle	\$139.95
11547	13:1 Gear Crank with 30" crank handle	\$183.95
11548	14" Drill Crank (For GFAM07 & GFAM13)	\$23.95
11550	120" Crank handle (For GFAM07 & GFAM13)	\$52.95
11551	Loop Handle (For GFAM07 & GFAM13)	\$41.95

Steel Swivel Lock & Hand Crank

Simple roll up crank. Includes locking universal joint and hand crank. Use 1.315" pipe to connect the pieces (not included). Pipe should be long enough so that handle locks against the ground. Only recommended for rollup sides or doors that are 36' or shorter.

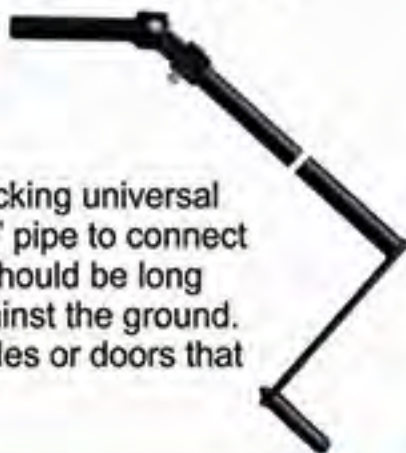

Item #	Description	Price
10724	Hand Crank & Swivel Lock	\$27.95

Manual Gear Crank for Doors

Doesn't require a guide pipe and allows the roll pipe to touch the ground. Ideal for doors or curtains that don't reach to the end of the structure. Stays attached to the roll pipe and is held at the correct height by securing handle to sidewall. 7:1 ratio with internal brake. Fits 1.315" roll pipe. 1.66" adapters also available.



Item #	Description	Price
GFAM07LH3	7:1 Gear Crank with 3' long handle	\$166.95

Low Voltage Controllers

For ventilation control on roll up sides and roof vents with low voltage motor packages. 110VAC input, 24VDC output. Also controls heaters and fans. All controllers have manual override.



GFA5VCU2



GFA5VC40



GFA5VCU4

Item #	Description	Price
GFA5VCU2	Controller; 1 stage of rollups (1 or 2 motors) + 2 stages dry contacts for heaters, fans, etc.	\$795.00
GFA5VC40	Touchscreen Controller; 2 stages of rollups (3 motors) + 2 stages contacts for heaters, fans, etc. With timed weather and humidity override. Rain, humidity & wind sensors not included.	\$1165.00
GFA5VCU4	Controller; 4 stages of rollups, or 3 stages rollups (3 motors) + 2 stages dry contacts for heaters, fans, etc.	\$1475.00
GFA5CIB	Contact to run fans, max 25 amps	\$122.50
GFA5VHS	Optional Humidity Sensor (override)	\$239.95

Also available: Solar powered controllers and interface boxes to accept signals from other controllers. Call for prices.

Low Voltage Motor Operator Packages

Energy efficient yet powerful! 24VDC motors for above controllers. Rolls up to 6 x 200' curtain. Includes roller guide, adapter for 1.315" roll pipe and guidepipe hardware. Use 1.315" guidepipe.



Item #	Description	Price
11558	60NM, rolls up to 5' x 200' curtain	\$274.95
11559	Limit Switch, required if using with Roll-Lock	\$98.95

Solarside® Woven Curtain Poly

Great for rollup curtains, rollup doors or gable end covering.

- More durable and puncture resistant than 6mil poly.
- Lightweight and extremely strong
- Diffuses light evenly
- UV Stabilized
- 87% Light transmission
- 6.8 oz/sq. yd.



Priced and sold by the linear foot.

Item #	Description	1'-99'	100'-199'	200'+
FRS06	6' Solarside Reinforced Poly	\$2.00	\$1.88	\$1.78
FRS13	13' Solarside Reinforced Poly	\$3.88	\$3.66	\$3.46

Greenhouse Doors

Greenhouse doors, ready to install. High quality aluminum construction with two polycarbonate windows.

Optional: Tempered glass for top window.

Allow 4-6 weeks lead time.

Except sizes marked with #, which we try to keep in stock.

Single Sliding: Optional – add \$14.50 for Bottom Seal Brush

All Polycarbonate		With Temp. Glass Top Half	
DSS 200	3' x 7'	\$490.00	DSSGT200 3' x 7' \$505.00
DSS 201	3' x 8'	\$530.00	DSSGT201 3' x 8' \$550.00
DSS 202	4' x 7' #	\$530.00	DSSGT202 4' x 7' \$550.00
12277	4' x 8' #	\$575.00	DSSGT203 4' x 8' \$605.00

Includes: Standard Latch, Brushes (two sides & top), Aluminum Track & Rollers, 2 Pull Handles, 1 Stay Roller, and 1 Door Guide

Double Sliding: Optional – add \$29.00 for Bottom Seal Brush

All Polycarbonate		With Temp. Glass Top Half	
DDS 250	3' x 7'	\$760.00	DDSGT250 3' x 7' \$795.00
DDS 251	3' x 8'	\$825.00	DDSGT251 3' x 8' \$870.00
13281	4' x 7' #	\$840.00	DDSGT252 4' x 7' \$890.00
11754	4' x 8' #	\$915.00	DDSGT253 4' x 8' \$975.00

Includes: Standard Latch, Brushes (two sides & top), Aluminum Track and Rollers, 4 Pull Handles, 2 Stay Rollers, 1 Cane Bolt, 1 Door Stay and Fasteners.

Single Hung

All Polycarbonate		With Temp. Glass Top Half	
DSH 100	3' x 7' #	\$505.00	DSHGT100 3' x 7' # \$520.00
DSH 101	3' x 8'	\$535.00	DSHGT101 3' x 8' \$555.00
12601	4' x 7' #	\$540.00	13328 4' x 7' \$560.00
DSH 103	4' x 8'	\$570.00	DSHGT103 4' x 8' \$600.00

Includes: Commercial Lever Latch, 1 Door Stop, 1 Bottom Sweep & Fasteners. **Outswing with hinges on left (outside).**



Pictured: 3' x 7' Double Hung (view from inside of the door)

Double Hung

All Polycarbonate		With Temp. Glass Top Half	
DDH 150	3' x 7'	\$785.00	DDHGT150 3' x 7' # \$810.00
DDH 151	3' x 8'	\$835.00	DDHGT151 3' x 8' \$875.00
DDH 152	4' x 7'	\$840.00	DDHGT152 4' x 7' \$880.00
DDH 153	4' x 8'	\$905.00	DDHGT153 4' x 8' \$965.00

Includes: Commercial Lever Latch, 2 Door Stops, 2 Bottom Sweeps, 1 Pull Chain, 1 Cane Bolt Fasteners and Center Astragal. **Main door is Outswing with hinges on left (outside).**

Basic Roll-up Doors for High Tunnels

We can quote based on the size needed. Up to 9'x23' for our 30' structures.

Use: 6.8 oz woven curtain poly, single wirelock across the top, 2 runs (center and bottom) of 1.6" galvanized pipe with roll-bar cap and a low wall gear crank or swivel lock and hand crank for smaller doors.

Pictured: Basic roll-up doors with swivel lock and hand crank and regular 6 mil plastic.



DCBI Corrugated Metal Roll-up Doors

26-gauge galvanized, polar white, grade E hard steel curtain with 5/8" ribbed corrugation. All models listed below are wind rated at 90 plus MPH. Unlike most other brands these doors have corrugated drum to prevent misalignment and for quieter operation. 9-1/2 to 12" drum diameter (depending on door size). For more info visit www.dcbi.com. We can custom order most any size. Also available with interior Mylar insulation. Call for quotation.

Item #	Description	Price
MRD1609	16' wide x 9' high, HD Series 3000 w/chain hoist, wind clips, ACE guide system	\$1600.00
MRD1209	12' wide x 9' high, HD Series 2500 with chain hoist & ACE guide system	\$1100.00
MRD1009	10' wide x 9' high, Series 690, 16ga galv steel guides & windbar, no chain hoist	\$600.00
MRD0808	8' wide x 8' high, Series 650, 18-gauge galv steel guide system, no chain hoist	\$475.00



Aluminum Shutters



These aluminum shutters from J&D are designed to be used as an inlet, but may also be used for free-air exhaust. Nylon bushings, solid shafts, drawn cup-type sleeves on all movable linkages.

Item #	Description	Price
JAS16	16" Single Panel Shutter	\$54.95
4925	24" Single Panel Shutter	\$72.95
JAS30	30" Single Panel Shutter	\$96.95
JAS36	36" Double Panel Shutter	\$111.95
JAS40	40" Double Panel Shutter	\$138.95
11704	42" Double Panel Shutter	\$154.95
12298	48" Double Panel Shutter	\$176.95
JAS54	54" Double Panel Shutter	\$209.95
JAS60	60" Double Panel Shutter	\$264.95



For rough opening size for shutters: add 1/2" to shutter size (both dimensions).

Shutter Motor Kits

Works with all the above shutters. 115/230V. Includes: motor, lever arm, chain, s-hooks, tension springs, mounting bracket and assembly hardware.



Item #	Description	Price
10481	Shutter Motor Kit	\$78.95

Univent Automatic Opener

Can be adjusted to open at between 60°-70°F. Fully open at 86°F. Works on 30" & smaller aluminum shutters (see above). Opens window/vent up to 18". Lifts up to 33 lbs.



Item #	Description	Price
JAS1A	Univent Automatic Opener	\$47.95
JAS1AH	Hardware to mount to above shutters	\$2.00

Shutter & Slantwall Fans



Shutter Fan, shown above left: features heavy-duty combination motor mounted/safety guard with bright easy-to-clean zinc-chromate finish.

Slantwall Fan, shown above right: features galvanized box, Direct drive motors, except 11610 and 11611 are belt drive, wire mesh guard. 11611 features cone for better performance.

Item #	Size	CFM	HP/RPM	Rough Opening	Price
11605	12"	970	1/10 hp/1,625	12-5/8"	\$155.95
11606	16"	1,440	1/10 hp/1,625	16-5/8"	\$166.95
4926	20"	3,140	1/3 hp/1,725	20-5/8"	\$220.95
11607	24"	4,640	1/2 hp/1,725	24-5/8"	\$253.95
11608	30"	6,770	1/2 hp/825	30-5/8"	\$336.95
11609	30"	7,100	1/2 hp/825	38"H x 37"W	\$480.95
11610	36"	9,700	1/2 hp belt drive/525	42"H x 41"W	\$833.95
11611	50"	21,600	1 hp belt drive/588	57"H x 55"W	\$1002.95

Circulation Fans



With 10' cord, pre-wired for 115 volts, single phase. Totally enclosed, maintenance-free, direct drive high-efficiency motors have completely sealed ball bearings. Motors are variable speed capable (controller must be sourced separately).



Item #	Description	Price	4+
11543	20" EZ-Breeze Fan, 1,680 CFM 1/10 hp, 1.08 amps	\$126.95	\$123.95
JHF12 and JHF20: Front can be opened for cleaning.			
11783	12" Green Breeze Fan, 970 CFM 1/10 hp, 1.12 amps	\$132.95	\$129.95
4805	20" Green Breeze Fan, 3,650 CFM 1/3 hp, 3.52 amps	\$179.95	\$174.95

Circulation Fan HESSAIRE

This 12" Hessaire circulation fan features industrial grade aluminum blades. Guards are powder coated. Bracket included. Single phase, 115V, 1.0A, 1/10 hp motor. **1,085 CFM**



Item #	Description	Price
11544	12" Hessaire Circulation Fan	\$87.95

Euroemme Heavy-Duty Exhaust Fans

Centrifugal shutter system keeps the efficiency of the fan at peak all the time by keeping the shutters fully open. Shutters do not have to be cleaned regularly. Heavy duty galvanized shutters are tightly closed when the fan is not in operation, preventing any air leakage. Considering the effect of dirty shutters on the other slant wall fans, the efficiency of the Euroemme fan is 15-25% better than any other fan.



Item #	Size	CFM @ 0" Static Pres.	Motor	Rough Opening	Price
11545	36"	11,650	1/2 hp	43"	Call for price & availability
11546	50"	20,500	1 hp	54 1/2"	Call for price & availability

A complete ventilation system is essential for all greenhouse applications.

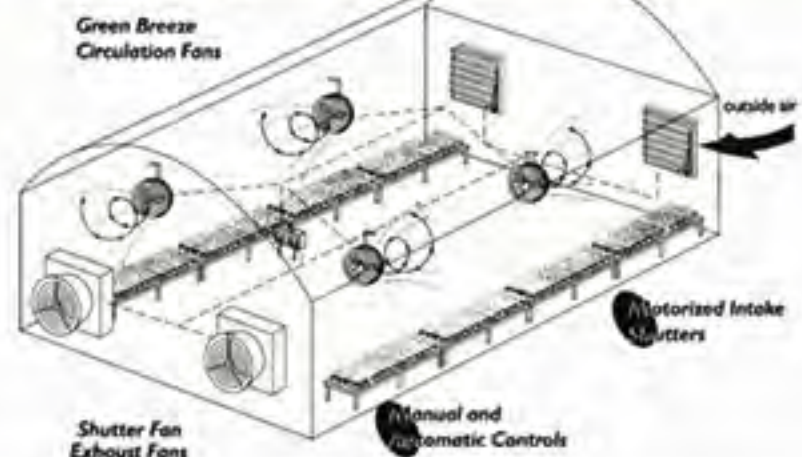

Modine Gas-Fired Unit Modine Model PTP

Stainless Steel Heat Exchangers for longer life. 80% Efficiency. Modine's horizontal power vented PTP unit heater line. Electronic Ignition with 100% shutoff and continuous retry. Power vent does not require vertical vent pipe.



Item #	BTU/hr Input/Output	CFM	Vent Size	Weight	Price
MPTP150*	150,000/120,000	2,140	4"	165 Lbs	\$995.00
MPTP175*	175,000/140,000	2,725	4"	210 Lbs	\$1,065.00
4906*	200,000/160,000	2,870	4"	220 Lbs	\$1,132.95
MPTP250*	250,000/200,000	3,995	6"	265 Lbs	\$1,395.00
MPTP300	300,000/240,000	4,545	6"	270 Lbs	\$1,575.00

Modine Model PDP

80% Efficiency. Modine's vertical power vented PDP unit heater line. Electronic ignition with 100% shutoff and continuous retry. Power vent does not require vertical vent pipe.



Item #	BTU/hr Input/Output	CFM	Vent Size	Weight	Price
MPDP150	150,000/120,000	2,180	5"	168 Lbs	\$995.00
MPDP175	175,000/140,000	2,550	5"	175 Lbs	\$1,059.95
11564	200,000/160,000	2,870	5"	239 Lbs	\$1,112.95
11563	250,000/200,000	3,700	6"	239 Lbs	\$1,379.95

All Modine heaters are for LP gas (propane) unless otherwise specified. ITEM #'s MARKED * ARE ALSO STOCKED FOR NATURAL GAS. Specify when ordering by adding "N" to the item #'s (e.g. MPTP150N) We can also order other models for natural gas (4-6 weeks leadtime)

Thermostats

These corrosive environment thermostats can be wired for heating or cooling. Up to 240Vac. SS sensor. Temperature range: 40°-100°F.

Item #	Description	Price
4774	Single Stage Thermostat	\$29.95
10483	2 Speed Thermostat	\$129.95
11565	2 Stage Thermostat	\$108.95
ECCW005	Waterproof Cord Connector	\$3.85



4774

Twister Exhaust Fan

For Convection Tubing (will reduce CFM) Galvanized Exhaust/Tube Fan, has center hinged galvanized butterfly shutter that can easily be removed for tube applications.



Item #	Description	Price
11568	24" Fan, 4820 CFM, 1/3 hp motor	\$301.95

When ordering please specify Propane or Natural Gas



Modine Effinity93

Modine Model PTC. With Stainless Steel Heat Exchangers for longer life. At 93% efficiency, Modine's Effinity⁹³ is the most efficient condensing unit heater in North America. Direct Spark Ignition. Power Exhaust. High Efficiency Separated Combustion. Use PVC Vent pipe, use same size pipe for combustion air inlet. (Do not draw combustion air out of greenhouse.) Drains an acidic condensate. *Vent and drain must be installed properly.*



Item #	BTU/hr Input/Output	CFM	Vent Size	Weight	Price
MPTC085	85,000/79,050	1,650	3"	125 Lbs	\$1,945.00
MPTC135	135,000/125,550	2,160	3"	165 Lbs	\$2,745.00
MPTC180	180,000/167,400	3,020	4"	215 Lbs	\$2,945.00
MPTC215	215,000/199,950	3,865	4"	265 Lbs	\$3,475.00
MPTC260	260,000/241,800	4,585	4"	265 Lbs	\$3,695.00

Modine Hot Dawg

Electronic Ignition with 100% shutoff and continuous retry. Power vent does not require vertical vent. 80% Efficiency.



Item #	BTU/hr Input/Output	CFM	Vent Size	Weight	Price
MHD045*	45,000/36,000	720	3"	60 Lbs	\$649.95
MHD075*	75,000/60,000	1,160	3"	85 Lbs	\$749.95
MHD100*	100,000/80,000	1,490	4"	125 Lb	\$865.00
MHD125*	125,000/100,000	1,980	4"	128 Lb	\$895.00

Convection Tubing Ken-Bar

Kenbar convection tubing is made from clear polyethylene and is protected with a strong ultraviolet inhibitor. The plastic is formulated for maximum light penetration and for durability in a greenhouse environment.



Convection Tubing Punch Positions

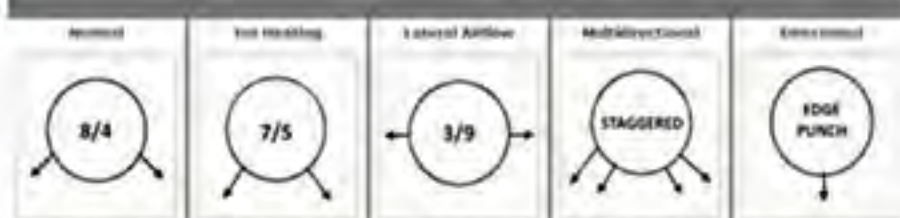

8/4 punch is standard unless otherwise specified. For staggered or edge punch add \$0.12/ft.

Item #	Description	Price
GCT612	12" Dia. Tubing, 6 mil 3 year	\$0.85
GCT618	18" Dia. Tubing, 6 mil 3 year	\$1.10
GCT624	24" Dia. Tubing, 6 mil 3 year	\$1.35
GCT630	30" Dia. Tubing, 6 mil 3 year	\$1.59

Small Order Up charge on orders less than \$50.

NON-STOCK Greenhouse Frames

These frames feature 2-3/8" arches and 6' arch spacing. Contact us for pricing on custom frames or other lengths.

30' Gothic Greenhouse, 5' Straight Sides

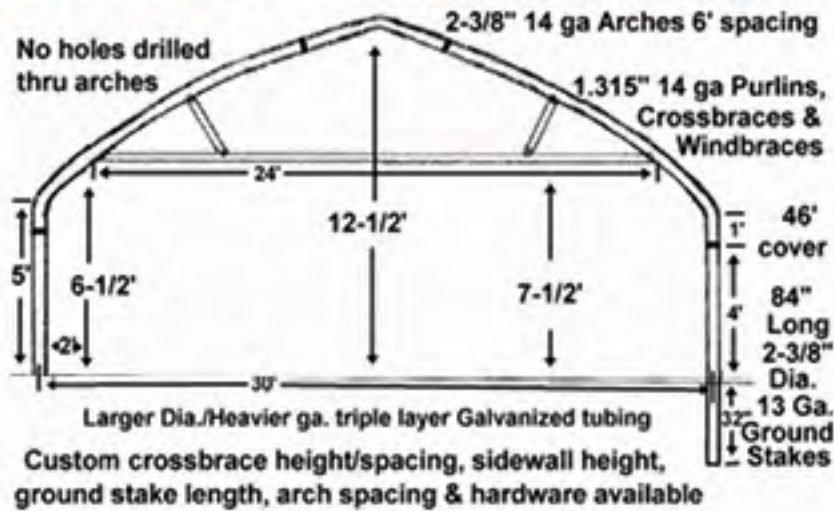

This 30' frame includes crosstie assembly on each arch except end arches, and has 5 purlins and 4 wind braces. Hardware: cross connectors & pipe straps for fastening purlins, bolts & pipe straps for baseboard end wall brackets, assembly instructions and stake driver.

Size	Price
30' x 48'	\$2,200.00
30' x 72'	\$3,250.00
30' x 96'	\$4,150.00

34' Gothic Greenhouse, 5' Straight Sides

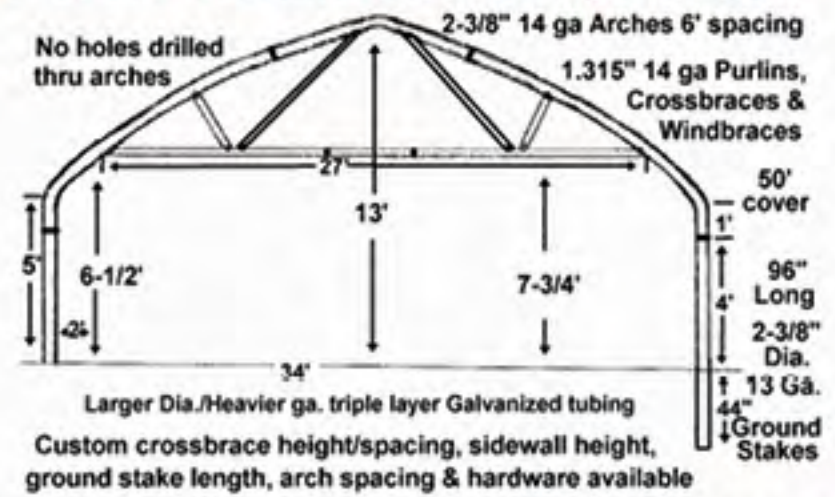

This 34' frame includes crosstie assembly on each arch except end arches, and has 7 purlins and 4 wind braces. Hardware: cross connectors & pipe straps for fastening purlins, bolts & pipe straps for baseboard, end wall brackets, assembly instructions and stake driver.

Size	Price
34' x 72'	\$4,250.00
34' x 96'	\$5,300.00
34' x 144'	\$7,800.00
34' x 198'	\$10,000.00



Greenhouse (High Tunnel) Sample Packages

These high tunnel packages include two layers of plastic, inflation blower, plastic for end walls, and two roll-up sides. Frame includes all hardware & parts required for assembly including lugs & straps to fasten baseboard and a detailed construction manual.

Some other basic items that you will need to obtain include: Doors, Treated lumber to frame end walls (2x4 and/or 4x4) and for baseboards (2x8 or 2x10). You may also need electrical wiring, propane and water plumbing.

Add-ons we stock: Roll-Lock to secure roll-up pipe (recommended if heating), heaters, exhaust and circulation fans, intake shutters, black ground cover, polycarbonate twin wall sheeting, temperature alarms, purlins for hanging baskets, etc.

These are sample quotes and can be customized to your requirements. Contact us for custom quotes or quotes on other sizes.

21' x 48'

Qty	Unit	Item #	Item Description	Rate	Amount
1	ea	C2148	21x48' Peaked Greenhouse Frame	1,890.00	1,890.00
1	ea	T4636110	36x110' 6 Mil 4 Year Tufile IV Plastic	316.80	316.80
1	ea	T4614	14x100' 6 Mil 4 Year Tufile IV Plastic	112.00	112.00
1	ea	GGAS00	3/4"x500 Batten Tape	31.50	31.50
1	ea	GEA1480	4 Bolt Blower KIT 148 CFM w/Cord 115V	68.00	68.00
1	ea	GEA1481	4 Bolt Blower Mounting Kit	17.00	17.00
8	Pcs	GFA1	8" Single WireLock Base	5.70	51.30
8	Pcs	GFA1090	12" DOUBLE WireLock Base	22.00	176.00
2	100 Pcs	GFA2121	1" #12 SS Self Drilling TEK Screw	12.20	24.40
2	50/BUND	GFA104	4" ZigZag Wire	36.00	72.00
2	ea	GFA104	GCS-18 S-1 GearCrank w/1.315" adapter	79.00	158.00
2	ea	GFA104P	6" Guide Pipe Assy. for S-1 GearCrank	16.00	32.00
12	ea	GFA5RH	Aluminum Rope Hooks	27.00	324.00
14	ea	ZES04003	4" Zinc Plated Eye Screw 5/16"	0.65	9.10
1	250' Roll	GFA3CR	1/4" Rope Need/Braid Black 100% polyester	34.75	34.75
10	ea	FC 010	1" Fabric Clip, Fits 1-3/8" OD Pipe	0.80	8.00
8	ea	GGP1312175	1-3/8" 17ga 147" Sweelged Purlin Pipe	10.40	83.20
1	ea	GFA3RPH2X	Roll-pipe Hanger for 2" Baseboard, 9PK	17.50	17.50
Total:				\$ 2,736.05	

30' x 72'

Qty	Unit	Item #	Item Description	Rate	Amount
1	ea	C3072	30x72' Gothic Greenhouse Frame	3,610.00	3,610.00
1	ea	T4648150	48x150' 6 Mil 4 Year Tufile IV Plastic	576.00	576.00
1	ea	T4614	14x100' 6 Mil 4 Year Tufile IV Plastic	112.00	112.00
1	ea	GGAS00	3/4"x500 Batten Tape	31.50	31.50
1	ea	GEA1480	4 Bolt Blower KIT 148 CFM w/Cord 115V	68.00	68.00
1	ea	GEA1481	4 Bolt Blower Mounting Kit	17.00	17.00
8	Pcs	GFA10	12" Single WireLock Base	8.55	68.40
12	Pcs	GFA1090	12" DOUBLE WireLock Base	19.80	237.60
2	100 Pcs	GFA2121	1" #12 SS Self Drilling TEK Screw	12.20	24.40
120	ea	GFA104	4" ZigZag Wire	0.72	86.40
2	ea	GFA104	GCS-18 S-1 GearCrank w/1.315" adapter	79.00	158.00
2	ea	GFA104P	6" Guide Pipe Assy. for S-1 GearCrank	16.00	32.00
1	25/Pk	GFA5RH	Aluminum Rope Hooks	27.00	27.00
20	ea	ZES04003	4" Zinc Plated Eye Screw 5/16"	0.65	13.00
1	250' Roll	GFA3CR	1/4" Rope Need/Braid Black 100% polyester	34.75	34.75
74	ea	FC 010	1" Fabric Clip, Fits 1-3/8" OD Pipe	0.80	59.20
12	ea	GGP1312175	1-3/8" 17ga 147" Sweelged Purlin Pipe	10.40	124.80
1	ea	GFA3RPH2X	Roll-pipe Hanger for 2" Baseboard, 9PK	17.50	17.50
Total:				\$ 5,292.75	

21' x 72'

Qty	Unit	Item #	Item Description	Rate	Amount
1	ea	C2172	21x72' Peaked Greenhouse Frame	2,130.00	2,130.00
1	ea	T4636150	36x150' 6 Mil 4 Year Tufile IV Plastic	432.00	432.00
1	ea	T4614	14x100' 6 Mil 4 Year Tufile IV Plastic	112.00	112.00
1	ea	GGAS00	3/4"x500 Batten Tape	31.50	31.50
1	ea	GEA1480	4 Bolt Blower KIT 148 CFM w/Cord 115V	68.00	68.00
1	ea	GEA1481	4 Bolt Blower Mounting Kit	17.00	17.00
8	Pcs	GFA1	8" Single WireLock Base	5.70	51.30
12	Pcs	GFA1090	12" DOUBLE WireLock Base	19.80	237.60
2	100 Pcs	GFA2121	1" #12 SS Self Drilling TEK Screw	12.20	24.40
2	50/BUND	GFA104	4" ZigZag Wire	36.00	72.00
2	ea	GFA104	GCS-18 S-1 GearCrank w/1.315" adapter	79.00	158.00
2	ea	GFA104P	6" Guide Pipe Assy. for S-1 GearCrank	16.00	32.00
1	25/Pk	GFA5RH	Aluminum Rope Hooks	27.00	27.00
20	ea	ZES04003	4" Zinc Plated Eye Screw 5/16"	0.65	13.00
1	250' Roll	GFA3CR	1/4" Rope Need/Braid Black 100% polyester	34.75	34.75
74	ea	FC 010	1" Fabric Clip, Fits 1-3/8" OD Pipe	0.80	59.20
12	ea	GGP1312175	1-3/8" 17ga 147" Sweelged Purlin Pipe	10.40	124.80
1	ea	GFA3RPH2X	Roll-pipe Hanger for 2" Baseboard, 9PK	17.50	17.50
Total:				\$ 3,637.25	

30' x 96'

Qty	Unit	Item #	Item Description	Rate	Amount
1	ea	C3096	30x96' Gothic Greenhouse Frame	4,695.00	4,695.00
1	ea	T4648	48x190' 6 Mil 4 Year Tufile IV Plastic	584.00	584.00
1	ea	TES48	48x190' 6 Mil 4 Year Tufile infrared Plastic	441.60	441.60
1	ea	T4614	14x100' 6 Mil 4 Year Tufile IV Plastic	112.00	112.00
1	ea	GGAS00	3/4"x500 Batten Tape	31.50	31.50
1	ea	GEA1480	4 Bolt Blower KIT 148 CFM w/Cord 115V	68.00	68.00
1	ea	GEA1481	4 Bolt Blower Mounting Kit	17.00	17.00
8	Pcs	GFA10	12" Single WireLock Base	8.55	68.40
16	Pcs	GFA1090	12" DOUBLE WireLock Base	19.80	316.80
3	100 Pcs	GFA2121	1" #12 SS Self Drilling TEK Screw	12.20	36.60
3	50/BUND	GFA104	4" ZigZag Wire	36.00	108.00
2	ea	GFA104	S-1 GearCrank w/1.315" adapters	79.00	158.00
2	ea	GFA104P	6" Guide Pipe Assy. for S-1 GearCrank	16.00	32.00
1	25/Pk	GFA5RH	Aluminum Rope Hooks	27.00	27.00
20	ea	ZES04003	4" Zinc Plated Eye Screw 5/16"	0.65	13.00
1	250' Roll	GFA3CR	1/4" Rope Need/Braid Black 100% polyester	34.75	34.75
100	ea	FC 010	1" Fabric Clip, Fits 1-3/8" OD Pipe	0.75	75.00
16	ea	GGP1312175	1-3/8" 17ga 147" Sweelged Purlin Pipe	10.00	160.00
1	ea	GFA3RPH2X	Roll-pipe Hanger for 2" Baseboard, 9PK	17.50	17.50
Total:				\$ 6,800.05	

21' x 96'

Qty	Unit	Item #	Item Description	Rate	Amount
1	ea	C2196	21x96' Peaked Greenhouse Frame	2,750.00	2,750.00
1	ea	T4636110	36x110' 6 Mil 4 Year Tufile IV Plastic	316.80	316.80
1	ea	TES36110	36x110' 6 Mil 4 Year Tufile infrared Plastic	264.32	264.32
1	ea	T4614	14x100' 6 Mil 4 Year Tufile IV Plastic	112.00	112.00
1	ea	GGAS00	3/4"x500 Batten Tape	31.50	31.50
1	ea	GEA1480	4 Bolt Blower KIT 148 CFM w/Cord 115V	68.00	68.00
1	ea	GEA1481	4 Bolt Blower Mounting Kit	17.00	17.00
8	Pcs	GFA1	8" Single WireLock Base	5.70	51.30
16	Pcs	GFA1090	12" DOUBLE WireLock Base	19.80	316.80
3	100 Pcs	GFA2121	1" #12 SS Self Drilling TEK Screw	12.20	36.60
3	50/BUND	GFA104	4" ZigZag Wire	36.00	108.00
2	ea	GFA104	GCS-18 S-1 GearCrank w/1.315" adapter	79.00	158.00
2	ea	GFA104P	6" Guide Pipe Assy. for S-1 GearCrank	16.00	32.00
1	25/Pk	GFA5RH	Aluminum Rope Hooks	27.00	27.00
20	ea	ZES04003	4" Zinc Plated Eye Screw 5/16"	0.65	13.00
1	250' Roll	GFA3CR	1/4" Rope Need/Braid Black 100% polyester	34.75	34.75
100	ea	FC 010	1" Fabric Clip, Fits 1-3/8" OD Pipe	0.75	75.00
16	ea	GGP1312175	1-3/8" 17ga 147" Sweelged Purlin Pipe	10.40	166.40
1	ea	GFA3RPH2X	Roll-pipe Hanger for 2" Baseboard, 9PK	17.50	17.50
Total:				\$ 4,693.47	

30' Gothic Greenhouse (or High Tunnel) Frame



See page 47 for more frame specifications.

21' Peaked High Tunnels:

- 10 1/2' to peak, 5' Straight Sidewall.
- Arches: 1.66" x 14 gauge, Stakes: 1.9" x 13 gauge.
- Purlins & windbraces: 1.315" x 17 gauge
- Crossties are optional.

L Series Packs (Inserts) Standard 1020 Size

Call for price on 8+ full skids.

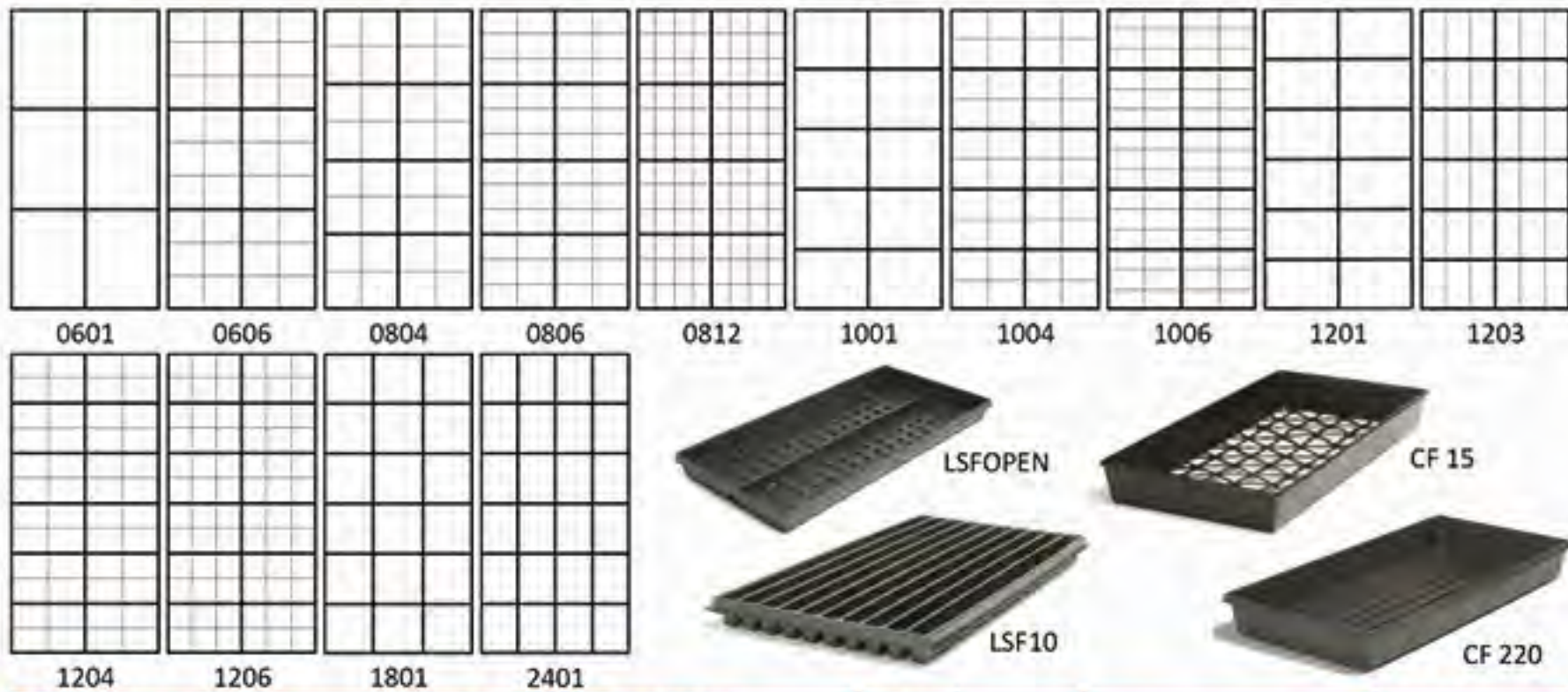

L Series Packs (Inserts) Standard 1020 Size (20.85" x 10.42")					Skid Qty	Mfg Code	Cell Dimensions			Pack Volume	
Item #	Description	Sheets/Cs	1-5 Cs	6-31 Cs			Length	Width	Depth	Liquid	Cu. In.
3452	601, 6 packs of 1 cell	100	\$51.75	\$56.25		L601	6.44	4.85	2.33	1.13 qt 65.05	
4207	606, 6 packs of 6 cells	100	\$43.50	\$47.95		L606	2.35	2.15	2.33	1.91 pt 55.10	
3494	804, 8 packs of 4 cells	100	\$43.50	\$47.95		L804	2.35	2.35	2.33	1.48 pt 42.72	
3495	806, 8 packs of 6 cells	100	\$43.50	\$47.95		L806	2.35	1.55	2.33	1.34 pt 38.81	
10321	812, 8 packs of 12 cells	100	\$51.75	\$56.25		L812	1.52	1.13	2.33	- -	
11059	1001, 10 packs of 1 cell	100	\$51.75	\$56.25	Ask	L1001	4.80	3.85	2.33	- -	
11061	1004, 10 packs of 4 cells	100	\$48.65	\$52.95	for	L1004	2.40	1.85	2.33	1.09 pt 31.44	
11062	1006, 10 packs of 6 cells	100	\$48.65	\$52.95	price	L1006	1.85	1.75	2.33	0.99 pt 28.63	
11063	1201, 12 packs of 1 cell	100	\$49.75	\$54.95		L1201	4.85	3.15	2.33	1.01 pt 29.29	
11064	1203, 12 packs of 3 cells	100	\$49.75	\$54.95		L1203	3.15	1.55	2.33	0.89 pt 25.81	
10641	1204, 12 packs of 4 cells	100	\$43.50	\$47.95		L1204	2.35	1.45	2.33	0.87 pt 25.14	
10409	1206, 12 packs of 6 cells	100	\$48.65	\$57.95		L1206	1.55	1.55	2.33	0.75 pt 21.60	
3496	1801, 18 packs of 1 cell	100	\$48.65	\$56.95		L1801	3.10	3.10	2.33	0.64 pt 18.55	
11065	2401, 24 packs of 1 cell	100	\$51.75	\$54.50		L2401	3.10	2.25	2.33	0.44 pt 12.75	

L Series Super Jumbo/Deep Packs, Stnd 1020 Size (20.85" x 10.42")					Skid Qty	Mfg Code	Cell Dimensions			Pack Volume	
Item #	Description	Sheets/Cs	1-5 Cs	6-31 Cs			Length	Width	Depth	Liquid	Cu. In.
4443	606, 6 packs of 6 cells	100	\$49.75	\$54.95	Ask	L606SJ	2.35	2.15	3.13	1.29 qt 74.69	
3451	804, 8 packs of 4 cells	100	\$53.75	\$58.95	for	L804SJ	2.46	2.47	3.05	1.55 pt 44.44	
2805	806, 8 packs of 6 cells	100	\$53.75	\$58.95	price	L806SJ	2.35	1.60	3.12	1.64 pt 47.27	
11067	1204, 12 packs of 4 cells	100	\$49.75	\$53.95		L1204D	2.63	1.72	2.75	1.02 pt 29.41	

L Series Trays, Carrying Trays and Seeder Trays (Standard 1020 size)

Item #	Description	Pcs/Cs	1-5 Cs	6-Skid	Skid Qty	Mfg Code	Length	Width	Depth
3492	Lightweight Solid Side, Web Bottom	50	\$24.50	\$23.50	54	IL1020SS	21.13	10.67	2.39
3595	Heavy Duty, Almost Solid Side, Web Bottom	50	\$33.95	\$32.95	48	Beldin 694213	21.13	10.65	2.40
2806	NCR Tray, Solid Side with Bottom Drain Holes	100	\$60.95	\$58.95	32	L1020NCR	21.22	10.80	2.33
4397	NCRN Tray, Solid Side and Bottom, NO Holes	100	\$61.95	\$59.95	32	L1020NCRN	21.22	10.80	2.33
11068	NCR Tray, Solid Side with Bottom Drain Holes, same as CF 22, but 50% thicker plastic	75	\$89.95	\$87.95	32	L1020NCR- HD	21.22	10.80	2.33
11069	Open Seeder Tray, Solid Side, Slitted Bottom	100	\$112.95	\$109.95	32	136ST	21.22	10.80	1.38
4529	10 Row Seeder Tray, Solid Side, Slitted Bottom	100	\$119.95	\$116.95	32	PSEED10	21.50	11.00	1.25

Square Pots



Press Fit, Landmark Plastics							Dimensions		Volume	
Item #	Description	Pcs/Cs	1-5 Cs	6-Skid	Skid Qty	Mfg Code	Dia.	Depth	Liquid	Cu. In.
4770	2.25 Square	1,920	\$82.00	\$81.00	36	225P	2.19	3.00	0.306 pt	8.85
3438	3.00 Square	800	\$39.00	\$38.00	52	3PF800	2.63	2.25	0.375 pt	10.8
3534	3.00 Square Deep	800	\$38.00	\$37.00	48	3PD800	2.63	3.50	0.59 pt	17.09
11254	3.25 Sq. Extra Deep	400	\$29.50	\$28.50	72	3PXD400	3.00	4.25	0.83 pt	23.98
4766	4.00 Square	450	\$33.50	\$32.50	48	4PF450	3.50	3.50	1.05 pt	30.33
4912	4.00 Sq. Extra Deep	450	\$49.00	\$48.00	32	4PXD	3.50	5.02	1.52 pt	43.94
3497	4.50 Square	375	\$36.50	\$35.50	28	45P375	4.19	3.63	1.69 pt	48.82
3440	4.50 Square Deep	375	\$45.50	\$44.50	28	45PD375	4.19	4.88	1.15 qt	66.64

Black w/Label Slots, Belden Plastics							Dimensions		Volume	
Item #	Description	Pcs/Cs	1-5 Cs	6-Skid	Skid Qty	Mfg Code	Dia.	Depth	Liquid	Cu. In.
11255	4.50 Jumbo Jr Square	375	\$69.00	\$68.00	32	691525	4.13	5.00	1.05 qt	N/A
11256	5.25 Jumbo Square	200	\$64.50	\$63.50	40	6915150	5.25	5.25	1.71 qt	N/A
11257	5.25 Jumbo Senior	200	\$66.00	\$65.00	40	691535	5.25	6.50	2.03 qt	N/A
11258	6.00 Magnum Square	150	\$59.50	\$58.50	40	691543	6.00	6.50	2.79 qt	N/A

Sheet of Pots



Lightweight pots in a perforated sheet, Landmark Plastics							Dimensions		Volume	
Item #	Description	Pcs/Cs	1-5 Cs	6-Skid	Skid Qty	Mfg Code	Diameter	Depth	Liquid	Cu. In.
110459	3.00 Square, 32 Cnt	100	\$72.50	\$71.50	24	3SQSP	2.45 x 2.47	3.00	0.387 pt	11.17
4209	3.50 Sq. Deep, 18 Ct	100	\$77.00	\$76.00	20	35SPXD	3.48 x 3.47	3.50	0.92 pt	26.55
4445	4.50 Square, 15 Cnt	100	\$111.00	\$110.00	16	45SP	4.09 x 4.09	3.65	1.55 pt	44.85

Square Pot



Square Pot Trays							Dimensions		
Item #	Description	Pcs/cs	1-5 Cs	6-Skid	Skid Qty	Mfg Code	Length	Width	Depth
4771	2.25 Sq. Pot Tray, 32 Count	100	\$81.00	\$80.00	40	2SPT32	18.10	9.12	2.25
3439	3.00 Sq. Pot Tray, 32 Count	100	\$89.50	\$88.50	32	LPF32TRY	21.23	10.79	1.50
10552	3.00 Sheet of Pots Tray, 32 Ct	100	\$95.50	\$94.50	32	3SPT32	21.23	10.79	2.00
10259	3.25 Sq. Extra Deep Tray, 20 Ct	100	\$132.50	\$131.50	36	3PXD20	15.19	12.19	2.00
3394	4.00 Sq. Pot Tray, 18 Count	100	\$87.50	\$86.50	32	LPF18TRY	21.23	10.79	2.31
4446	4.50 Sq. Pot Tray, 15 Count	50	\$50.50	\$52.00	32	LPF15TRY	21.10	12.71	2.31
11260	4.50 Sq. Pot Tray, 12 Count	100	\$114.50	\$113.50	20	L45PF12	16.97	12.75	2.31
3223	4.50 Sq. Pot Tray, 10 Count	90	\$69.50	\$68.50	30	45SPT10	20.94	8.44	2.02
11261	Jumbo Sq. Pot Tray, 8 Count	50	\$91.50	\$90.50	18	698140	21.25	10.90	3.25
11262	Magnum Sq. Pot Tray, 6 Count	50	\$109.50	\$108.50	18	694225	18.00	12.00	3.25

Water-Matic Trays

Reservoir holds water while elevated overflow holes ensure that excess

Item #	Description	Pcs/cs	1-5 Cs	6-Skid	Mfg Code	Length	Width	Depth
11263	4.50 Square Tray, 15 ct 3x5	50	\$60.00	\$59.00	45SWM	21.05	12.61	2.44
11264	4.50 Rnd/Sq, 8 Ct 2x4 spaced	100	\$115.50	\$114.50	45RSWM	20.25	10.13	2.44



GREENHOUSE SUPPLY

Decorative Planters



11234



11233



11231



11229



DECK POTS, Round (Made in USA)			Price per case			Mfg Code	Dimensions		Volume	
Item #	Description	Pcs/Cs	1-5 Cs	6-Skid	Skid Qty		Dia.	Depth	Liquid	Cu. In.
11227	8" Clay, Trench Tek	150	\$76.50	\$75.50	18	KOBA	8.00	6.00	0.8 gal	184.79
11228	10" Clay, Trench Tek	70	\$60.50	\$59.50	32	KOBA	10.00	7.50	1.8 gal	425.9
11229	12" Clay	48	\$64.50	\$63.50	24	KOBA	12.00	9.00	3.5 gal	808.6
11230	14" Clay	20	\$47.50	\$46.50	27	KOBA	14.00	11.75	5.5 gal	1270.7

CURVE DECK POTS, Round (Made in USA)			Price per case			Mfg Code	Dimensions		Volume	
Item #	Description	Pcs/Cs	1-5 Cs	6-Skid	Skid Qty		Dia.	Depth	Liquid	Cu. In.
11231	12" Slate color	36	\$48.50	\$47.50	36	KOBA	12.00	9.25	2.7 gal	623.7
11232	16" Slate color	18	\$60.50	\$59.50	18	KOBA	16.00	12.2	6 gal	1418.8

Cut Flower Bucket

Solid base allowing for top-heavy blooms.			Price per case			Mfg Code	Dimensions		Volume	
Item #	Description	Pcs/Cs	1-5 Cs	6-Skid	Skid Qty		Dia.	Depth	Liquid	Cu. In.
11233	10" Black, no holes	30	\$32.50	\$31.50	40	KOBA	10.00	9	2.25 gal	519.8

Grow Pans Compatible hangers optimize greenhouse growing space.

Trench Tek bottom conserves water.			Price per case			Compatible Hangers	Dimensions		Volume	
Item #	Description	Pcs/Cs	1-5 Cs	6-Skid	Skid Qty		Dia.	Depth	Liquid	Cu. In.
11234	8" Green Deko Pan	246	\$122.50	\$121.50	18	SHBE10G, LG, W10	8.00	4	0.525 gal	125
11235	10" Green Deko Pan	130	\$85.50	\$84.50	40	SHBE10G, LG, W10	10.00	4.5	1.05 gal	248
11236	12" Green Deko Pan	116	\$122.50	\$121.50	24	SHBE12G, SHBW12	12.00	5	1.56 gal	365

Corrugated Retail Flats Self-Locking. No stapling required! Same size as standard 1020 flats.

Item #	Description	Bundle/75pcs	Skid/750pcs	Length	Width	Depth
11238	Carry Out Tray, Brown	\$37.50 = 0.50 ea	\$315.00 = 0.42 ea	21.25	10.50	2.50



True Series Inserts & Trays True 10"x20" size (These are NOT standard size)

For illustrations of pack layout see page 5			Skid Qty			Cell Dimensions			Pack Volume		
Item #	Description	Pcs/Cs	1-5 Cs	6-35 Cs	36 Cs	Mfg Code	Length	Width	Depth	Liquid	Cu. In.
3431	T 804 Pack	100	\$49.50	\$48.50		T804	2.28	2.24	2.61	1.52 pt	44.00
4377	T 806 Pack	100	\$49.50	\$48.50		T806	2.28	1.50	2.61	1.42 pt	40.90
INT1204	T 1204 Pack	100	\$49.50	\$48.50	Ask	T1204	2.25	1.45	2.61	0.94 pt	27.16
4378	T 1206 Pack	100	\$49.50	\$48.50	for	T1206	1.45	1.44	2.61	0.81 pt	23.40
11661	T 606 Super Jumbo Pack	100	\$52.50	\$51.50	price	T606SJ	2.21	2.03	3.25	1.14 qt	65.54
3432	T 1801 Sheet of Pots	100	\$54.50	\$53.50		T1801SP	3.14	3.18	3.27	0.78 pt	22.58
3433	T Web Bottom Carrying Tray	100	\$41.50	\$40.50		ITIM	20.00	10.00	2.63		

Market Packs & Handles 11253 & 11252

3 of these fit per CFT1 tray (see above)						Cell Dimensions			Pack Volume		
Item #	Description	Pcs/Cs	1-5 Cs	6-Skid	Skid Qty	Mfg Code	Length	Width	Depth	Liquid	Cu. In.
11252	306 Pack, T Pot 6 Count	300	\$82.50	\$81.50	32	TPP6	10.11	6.73	3.5	0.72 pt	20.75
11253	19" White Handle	300	\$36.50	\$35.50	-	19SEH	19	1	-	-	-

Decorative Planters

LANDMARK PLASTIC



3599



DPF14



DPH1050CB



11217



11221



11219

KHAN SATURN POTS, Round			Price per case			Mfg Code	Dimensions		Volume	
Item #	Description	Pcs/Cs	1-5 Cs	6-Skid	Skid Qty		Dia.	Depth	Liquid	Cu. In.
3455	10" Terra-Cotta	50	\$58.00	\$56.50	40	KSAT10	11.48	7.86	2.05 gal	473.6
4380	12" Terra-Cotta	40	\$61.50	\$60.00	30	KSAT12	13.45	9.27	3.45 gal	797.3
3599	14" Terra-Cotta	30	\$99.50	\$97.00	16	KSAT14	15.87	11.19	5.76 gal	1330.6
DPF14	14" Fluted, Terra-Cotta	30	\$64.00	\$62.00	16	KFPN14	14.25	9.50	3.62 gal	836.6

HICKORY BARREL (Wood look), Round			Price per case			Mfg Code	Dimensions		Volume	
Item #	Description	Pcs/Cs	1-5 Cs	6-Skid	Skid Qty		Dia.	Depth	Liquid	Cu. In.
DPH1050CB	10.5" Chocolate Brown	80	\$95.00	\$92.50	32	KCT270	10.50	7.50	1.83 gal	422
DPH13CB	13" Chocolate Brown	40	\$86.50	\$84.00	36	KCT340	13.00	9.60	3.5 gal	805
DPH1450CB	14.5" Chocolate Brown	30	\$80.00	\$78.00	36	KCT380	14.50	10.50	4.5 gal	1036

2 Piece SPARTA URN			Price per case			Mfg Code	Dimensions		Volume	
Item #	Description	Pcs/Cs	1-5 Cs	6-Skid	Skid Qty		Dia.	Depth	Liquid	Cu. In.
11217	12" White Urn	25	\$59.00	\$57.50	48	KCZ305	11.8	11.6	1.6 gal	374
11218	12" Black	25	\$51.00	\$49.50	48	KCZ305	11.8	11.6	1.6 gal	37

Botanica Series, Large Round			Price per case			Mfg Code	Dimensions		Volume	
Item #	Description	Pcs/Cs	1-5 Cs	6-Skid	Skid Qty		Dia.	Depth	Liquid	Cu. In.
11219	17.75" Tan, Vineyard	15	\$103.00	\$100.50	18	KCFP18	17.75	13.75	8.10 gal	1,886
11220	17.75" Bronze, Vineyard	15	\$112.00	\$109.00	18	KCFP18	17.75	13.75	8.10 gal	1,886
11221	17.5" Bronze, Prestige	20	\$112.00	\$109.50	18	KCF018	17.50	14.25	7.85 gal	1,814



11222



DPSQ11



11225



3454 with optional 3588



11226

TREASURE BOWLS			Price per case			Mfg Code	Dimensions		Volume	
Item #	Description	Pcs/Cs	1-5 Cs	6-Skid	Skid Qty		Dia.	Depth	Liquid	Cu. In.
4381	12" Terra-Cotta	50	\$54.50	\$53.00	48	KTSB12	12	5.67	1.55 gal	359.1
11222	12" Choc. Brown	50	\$54.50	\$53.00	48	KTSB12	12	5.67	1.55 gal	359.1
3456	14" Terra-Cotta	50	\$82.00	\$80.00	36	KTSB14	14	5.75	2.09 gal	482.1

SERENE SQUARES			Price per case			Mfg Code	Dimensions		Volume	
Item #	Description	Pcs/Cs	1-5 Cs	6-Skid	Skid Qty		Dia.	Depth	Liquid	Cu. In.
11223	7.50" Tan	100	\$71.00	\$69.00	60	KSMSQ75	7.50	7.25	1.11 gal	256.7
DPSQ11	11.50" Terra-Cotta	25	\$46.50	\$45.50	48	KSMQ115	11.50	10.00	3.50 gal	807.5

OVALS, Terra-Cotta			Price per case			Mfg Code	Dimensions		Volume	
Item #	Description	Pcs/Cs	1-5 Cs	6-Skid	Skid Qty		Dia.	Depth	Liquid	Cu. In.
11225	12" Panterra, ITML	50	\$84.00	\$82.00	64	PAP1200	13x6.5	5.00	0.97 gal	223.0
3454	16" Khan Fluted	50	\$83.00	\$81.00	36	KOVL16	16x6.75	6.00	1.82 gal	419.5
3588	Saucer for 16" Oval	50	\$43.00	\$42.00	72	KOVSL16	14.6x5.7	1.00	-	-

PLANTER BOX, Rectangular			Price per case			Mfg Code	Dimensions		Volume	
Item #	Description	Pcs/Cs	1-5 Cs	6-Skid	Skid Qty		Dia.	Depth	Liquid	Cu. In.
11226	7x14" Terra-Cotta	100	\$143.00	\$139.50	36	X714PB	7x14	4.19	1.36 gal	315.19

GREENHOUSE SUPPLY



MULTI-FORMES



11240 (basket)
11242 (hanger)



11247 (basket)
11242 (hanger)



11248 (basket)
11250 (hanger)



11246 (basket)
11251 (hanger)



11247 (basket)
11249 (stand)

Multi-Formes Baskets

Coco Fiber Nest Baskets, Black Wire			Price per case					
Item #	Description	Pcs/Cs	1-5 Cs	6-Skid	Skid Qty	Mfg Code	Depth	Volume
11239	12" Coco Fiber Nest Basket	12	\$62.50	\$61.50	36	400-J12CO	6.5"	2.13 gal
11240	14" Coco Fiber Nest Basket	12	\$73.50	\$72.50	45	400-J14CO	7.0"	3.13 gal
11241	16" Coco Fiber Nest Basket	12	\$91.50	\$90.50	30	400-J16CO	7.0"	4.25 gal
Black Wire Hangers for all above Baskets								
11242	22" 3 Strand, Open Hook Hanger	12	\$17.50	\$16.50	75	400-HK22PN		
Pre-formed Replacement Coco Nest Liners								
11243	12" Coco Replacement Liner	12	\$21.50	\$20.50	36	401-L12		
11244	14" Coco Replacement Liner	12	\$26.50	\$25.50	36	401-L14		
11245	16" Coco Replacement Liner	12	\$32.50	\$31.50	36	401-L16		
Decorative Baskets, Natural Bark and Wicker with Plastic Liner								
Item #	Description	Pcs/Cs	1-5 Cs	6-Skid	Skid Qty	Mfg Code	Depth	Volume
11246	14" Flat Bark Basket	12	\$97.50	\$96.50	24	750-61	6.0"	2.00 gal
11247	14" Cone Bark Basket	12	\$100.50	\$99.50	24	750-62	15.0"	2.25 gal
11248	14" Cone Wicker & Rice Basket	12	\$87.50	\$86.50	24	750-12	15.0"	3.25 gal
11249	Wire stand for Cone Baskets	30	\$63.50	\$62.50	12	780-VAL	-	-
Galvanized Hangers for all above Baskets								
11250	22" 3 Strand, Galvanized WIRE Hanger	12	\$9.50	\$9.25	36	400-HK22		
11251	22" 3 Strand, Galvanized CHAIN Hanger	12	\$31.50	\$31.50	24	400-CH22		

Hanging Baskets



3458



11308



10232



11310

LANDMARK PLASTIC

DILLEN-ITML
The HC Companies

Hanging Baskets, Landmark Plastics			Price per case				Dimensions		Volume		Compatible Hangers
Item #	Description Saucerless = Inside Saucer	Pcs/Cs	1-5 Cs	6-Skid	Skid Qty	Mfg Code	Dia.	Depth	Liquid Gal.	Cu. In.	
4211	White 10" Imperial Deco, Saucerless	50	\$34.00	\$33.00	50	IHB10	10	6.5	1.5	346.5	SHBE10, E10L, W10
4210	Green 10" Imperial Deco, Saucerless	50	\$34.50	\$33.50	50	IHB10	10	6.5	1.5	346.5	SHBE10G, LG, W10
11308	Choc. Brown 10" Imperial, Saucerless	50	\$35.00	\$34.00	50	IHB10	10	6.5	1.5	346.5	SHBE10LCB, W10
3458	White 10" Contempo Swirl, Saucerless	50	\$33.00	\$32.00	50	ICT10	9.88	6	1.28	295.05	SHBE10, E10L, W10
3459	Green 10" Contempo Swirl, Saucerless	50	\$33.50	\$32.50	50	ICT10	9.88	6	1.28	295.05	SHBE10G, LG, W10
10323	White 10" Swirl, WITH Snap-on Saucer	50	\$38.50	\$37.50	30	ICTS10	9.88	6	1.28	295.05	SHBE10, E10L, W10
10266	White 12" Deco Swirl, Saucerless	25	\$41.00	\$40.00	48	IDS12	11.81	7.22	2.25	520.23	SHBE12, SHBW12
10232	Green 12" Deco Swirl, Saucerless	25	\$41.50	\$40.50	48	IDS12	11.81	7.22	2.25	520.23	SHBE12G, SHBW12
SHB212B	Black 12" Deco Swirl, Saucerless	25	\$41.50	\$40.50	48	IDS12	11.81	7.22	2.25	520.23	SHBE12B, SHBW12

Hanging Baskets, ITML			Price per case				Dimensions		Volume		Compatible Hangers
Item #	Description Saucerless = Inside Saucer	Pcs/Cs	1-5 Cs	6-Skid	Skid Qty	Mfg Code	Dia.	Depth	Liquid Gal.	Cu. In.	
11310	White 11" Traditional, Saucerless	50	\$48.00	\$46.75	40	HTS11000	10.75	6.5	1.73	400	SHB118, E10, W10
11311	Green 11" Traditional, Saucerless	50	\$48.75	\$47.50	40	HTS11000	10.75	6.5	1.73	400	SHB118G, E10G, W10

Hangers, for Baskets

Item #	Description	Pcs/Pk	Price		Mfg Code	Type	Compatible Baskets	
			Per Pack	Pcs/Cs				Per Case
4364/3304	White 16" Plastic, 3 Strand	25	\$4.15	450	\$71.00	I16ACL	Double Clip	SHB710,210,10,511
4171/	Green 16" Plastic, 3 Strand	25	\$4.15	450	\$71.00	I16ACL	Double Clip	SHB710G,210G,511G
4810/4169	White 19" Plastic, 3 Strand	25	\$5.30	450	\$91.00	I19SPCL	Snap Clip	SHB710, 210, 10
4170/	Green 19" Plastic, 3 Strand	25	\$5.30	450	\$91.00	I19SPCL	Snap Clip	SHB710G, 210G
4444/	Choc. Brown 19" Plastic, 3 Strd	25	\$5.50	450	\$94.50	I19SPCL	Snap Clip	SHB710CB
3460/	White 18.75" Plastic, 3 Strand	25	\$7.10	500	\$136.00	HZP3LSNO	Double Clip	SHB511
3461/	Green 18.75" Plastic, 3 Strand	25	\$7.10	500	\$136.00	HZP3LSNO	Double Clip	SHB511G
10267/	White 22" Plastic, 4 Strand	25	\$6.85	500	\$130.00	K22ACL	Double Clip	SHB212
12030/	Green 22" Plastic, 4 Strand	25	\$6.85	500	\$130.00	K22ACL	Double Clip	SHB212G
SHBE12B	Black 22" Plastic, 4 Strand	25	\$6.85	500	\$130.00	K22ACL	Double Clip	SHB212B
10324/10326	21" Wire 3 strand, Galvanized	50	\$8.90	500	\$85.00	Z21LH50	Wrapped Wire	SHB710,210,10,511
11312/11313	24" Wire 4 strand, Galvanized	50	\$14.25	250	\$68.00	Z24164STW	Wrapped Wire	SHB212

GREENHOUSE SUPPLY

Mum Pans

3437



11280



3453



13356



Thermoformed has a flexible sidewall with rim design that has good hoop strength							Dimensions		Volume	
Item #	Description	Pcs/Cs	1-5 Cs	6-Skid	Skid Qty	Mfg Code	Dia.	Depth	Liquid	Cu. In.
3437	8.00 Black, Thermoformed	130	\$29.50	\$31.95	30	8MPMGT	8.0	5.0	3.04 qt	175.44
11278	8.00 Terra-Cotta, Thermoformed	130	\$33.50	\$35.95	30	8MPMGT	8.0	5.0	3.04 qt	175.44
11280	8.00 Green, Injection Molded	258	\$96.50	\$104.95	25	IMP800	8.0	5.0	3.09 qt	178.49
11276	9.00 Black, Thermoformed	140	\$37.00	\$39.95	25	9MPMGT	9.0	5.9	1.18 gal	271.9
3453	9.00 Terra-Cotta, Thermoformed	140	\$43.00	\$46.95	25	9MPMGT	9.0	5.9	1.18 gal	271.9
11277	9.00 Green, Thermoformed	140	\$43.00	\$46.95	25	9MPMGT	9.0	5.9	1.18 gal	271.9
13356	10" Black Haviland, Thermoformed	125	\$49.00	\$53.95	40	HP-10M	10.75	7.85	2.25 gal	520
13357	10" Terra-Cotta Haviland, Thermoformed	125	\$55.00	\$59.95	40	HP-10M	10.75	7.85	2.25 gal	520

White Plastic Labels

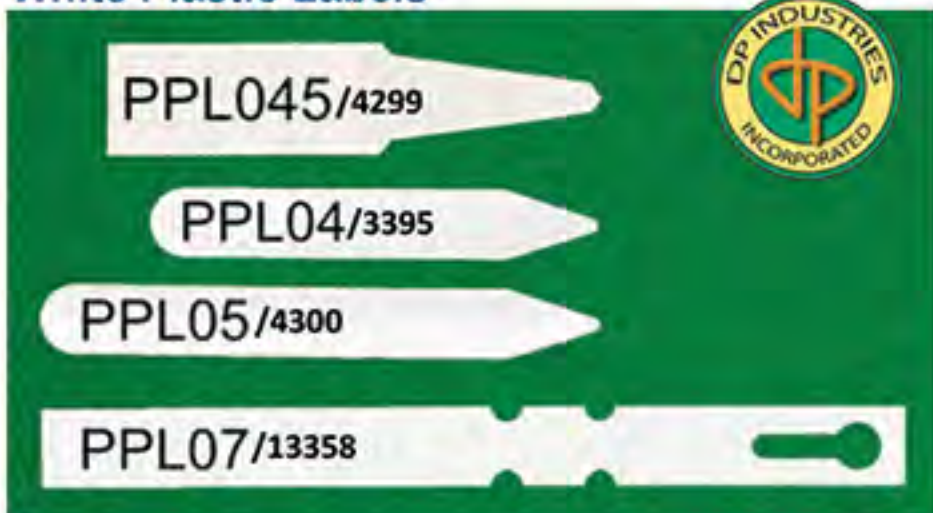

Item #	Description	1-9	10+
4299	4-1/2" x 1" (1,000/roll – perforated)	\$17.95	\$16.50
3395	4" x 5/8" (1,000/box – loose)	\$24.50	\$22.50
4300	5" x 5/8" (1,000/box – loose)	\$27.95	\$26.95
13358	7" x 5/8" loop tag (1,000/roll – perf)	\$27.95	\$26.95

Gro-Pot – Woven Planter Bag

Made with green 4.13 oz./Sq. Yd. UV stabilized woven cloth. Each pot has 2 sewn handles. Sold in packs of 25 pcs or bales of 100 pcs.



Item #	Description	Each	100/Pack
11528	9 Gallon, 14" x 14"	\$2.25	\$186.50
11529	12 Gallon, 15" x 15.75"	\$2.25	\$198.50
11530	15 Gallon, 16.5" x 17.75"	\$2.50	\$222.50

Wooden Baskets

Soft (woven) bottom. Great for pot covers for mums, etc. Half bushel and bushel basket have two wire handles.



Item #	Description	1-49	50+
BSB25	1 Peck, 11" Diameter x 7" Tall	\$2.95	\$2.70
BSB50H	1/2 Bushel, 14" Diameter x 9" Tall	\$3.45	\$3.20
BSB99H	Bushel, 18" Diameter x 11.5" Tall	\$4.00	\$3.70

Permanent Markers

Garden Marker: Fast

drying, waterproof pen that contain filters for maximum fade resistance. Alcohol-based ink. Xylene free.

Sharpie® Marker: Fine point permanent marker.



Item #	Description	Price	Quantity	Price
10442	Black Garden Marker	\$2.25	25+	\$1.80
10197	Black Sharpie Marker	\$1.10	12+	\$1.00

Liquid Chalk

Use with T-signs. Will not wash off from rain or general watering but it can be removed with a moist paper towel. Older writing (ghosting) can be cleaned with an alcohol based hand sanitizer.



Item #	Description	Price
11199	Liquid Chalk Markers, 3pk-Red, Green, Blue	\$18.00

WE ARE A DEALER FOR
NOLT'S
PRODUCE SUPPLIES.

CONTACT US FOR ANY
AVAILABILITY AND PRICES.

Nursery Containers, Thermoformed



Flexible sidewall with rim design that has good hoop strength.

Item #	Description	Pcs/Cs	Price Per Case				Mfg Code	Dimensions		Volume		Compatible Trays
			1-5 Cs	6-Skid	Skid Qty	Dia.		Depth	Liquid	Cu. In.		
11281	True Quart, 4.75" Black	600	\$63.50	\$62.00	24	TQTMGT	4.75	5.27	1.02 qt	59.10	SRT1Q-8	
11283	Trade Gallon, 6.5" Black	200	\$27.50	\$26.70	48	65NTGT	6.50	6.50	2.50 qt	144.00	SRTT1	
11284	True Gallon, 8" Black	140	\$35.95	\$34.95	70	HP-100	8.00	6.87	1.00 gal	231.00	NCCS1	
11286	Trade 2 Gallon, 8.5" Black	100	\$37.95	\$36.95	24	85NT2G	8.50	9.00	1.50 gal	346.20		
11288	Trade 2 Gallon, 9" Black	135	\$47.95	\$46.95	54	HP-175	9.00	8.50	1.50 gal	346.00		
11289	True 2 Gallon, 9.75" Black	135	\$56.50	\$54.50	46	HP-200	9.75	9.12	2.00 gal	462.00		
11290	True 3 Gallon, 11" Black	110	\$63.95	\$61.95	36	HP-300	11.00	9.69	3.00 gal	693.00		
13359	Trade 4 Gallon, 12.2" Black	55	\$47.50	\$46.00	48	HP-500	12.22	11.63	4.02 gal	924.00		

Nursery Containers, Injection Molded

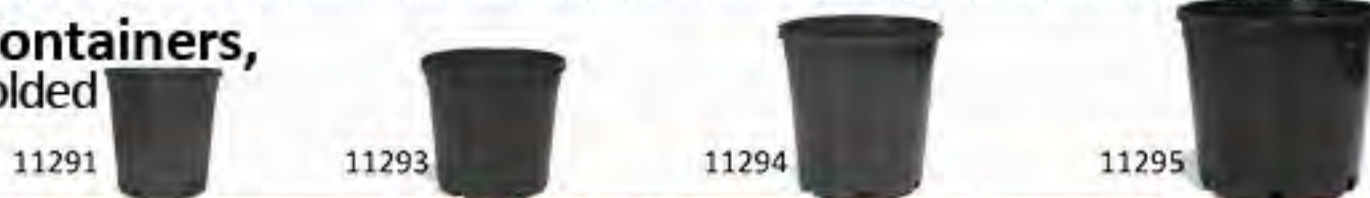

Item #	Description	Pcs/Cs	Price Per Case				Mfg Code	Dimensions		Volume		Compatible Trays
			1-5 Cs	6-Skid	Skid Qty	Dia.		Depth	Liquid	Cu. In.		
11291	Black 300 Trade Gallon	68	\$34.95	\$33.95	42	INCTGAL	6.13	6.87	2.64 qt	152.06	NCCT1	
11292	Terra-Cotta 300 Trade Gal	68	\$35.95	\$34.95	42	INCTGAL	6.13	6.87	2.64 qt	152.06	NCCT1	
11293	Black 400 True Gallon	75	\$57.95	\$55.95	30	INCSGAL	7.15	7.00	1.01 gal	232.38	NCCS1	
11294	Black 600 Trade 2 Gallon	65	\$56.95	\$54.95	29	INCT2GAL	8.04	8.50	1.47 gal	339.17		
3535	Terra-Cotta 600 Trade 2 Gal	65	\$57.95	\$55.95	29	INCT2GAL	8.04	8.50	1.47 gal	339.17		
11295	Black 1000 Trade 3 Gallon	59	\$99.95	\$96.95	16	INCT3GAL	10.41	9.50	2.79 gal	644.41		

Nursery Container, Transport Trays



Item #	Description	Pcs/cs	Price Per Case				Mfg Code	Dimensions			Compatible Pots
			1-5 Cs	6-Skid	Skid Qty	Length		Width	Depth		
11296	4.75" True Quart, 12 Count	60	\$79.95	\$77.95	24	QTWLL12	19.00	14.12	4.81	TWTT1Q	
11297	4.75" True Quart, 8 Count	75	\$64.95	\$62.95	36	QTTWL8	19.50	10.00	5.30	TWTT1Q	
11298	6.50" Trade Gallon, 6 Count	50	\$59.95	\$58.95	42	TGOF6	19.63	13.00	6.71	TWTT1	
11299	300 Trade Gallon, 6 Count	50	\$64.95	\$62.95	28	3QTCT	19.50	12.75	2.50	NC-T1	
11300	400 True Gallon, 6 Count	50	\$87.95	\$85.95	24	4QTCT	22.50	14.89	2.50	NC-S1	

Nursery Container, HPP Blow Molded



Black flexible pots with rounded top rim that has multiple handle grips.

Item #	Description	Pcs/Cs	Price Per Case				Dimensions		Volume	
			1-5 Cs	6-Skid	Skid Qty	Dia.	Depth	Liquid	Cu. In.	
4482	5 Gal, 500 Squat Series	30	\$42.95	\$41.95	48	14.00	10.00	5.00 gal	1,155	
13138	6 Gallon, 700 Series	30	\$44.95	\$43.95	48	14.00	11.50	6.08 gal	1,405	
Item #	Pots below sold by the piece	1-99	100-Ski	Skid Qty+	Skid Qty	Dia.	Depth	Liquid	Cu. In.	
11304	10-1/2 Gallon, 1000 Series	\$3.00	\$2.85	\$2.57	560	16.50	14.75	10.67 gal	2,465	
11305	13-1/2 Gallon, 1500 Series	\$3.25	\$3.10	\$2.68	480	18.20	16.00	13.66 gal	3,155	
11306	20 Gallon, 2000 Series	\$4.95	\$4.70	\$4.15	260	20.00	17.00	20.04 gal	4,629	
11307	27-1/2 Gallon, 2500 Series	\$5.25	\$4.80	\$4.25	300	24.00	18.00	27.50 gal	6,353	

GREENHOUSE SUPPLY

Square Pots



Press Fit, Landmark Plastics							Stock color: Black		Dimensions		Volume		Compatible
Item #	Description	Pcs/Cs	1-5 Cs	6-Skid	Skid Qty	Mfg Code	Dia.	Depth	Liquid	Cu. In.	Transport Trays		
PF 0225	2.25 Square	1,920	\$84.95	\$82.95	36	225P	2.19	3.00	0.306 pt	8.85	PF-10225		
PF 03	3.00 Square	800	\$38.95	\$36.95	52	3PF800	2.63	2.25	0.375 pt	10.8	PF-1030		
3534	3.00 Square Deep	800	\$38.95	\$36.95	48	3PD800	2.63	3.50	0.59 pt	17.09	PF-1030		
11254	3.25 Sq. Extra Deep	400	\$29.50	\$27.50	72	3PXD400	3.00	4.25	0.83 pt	23.98	PF-10320		
4766	4.00 Square	450	\$36.95	\$34.95	48	4PF450	3.50	3.50	1.05 pt	30.33	PF-1040		
4912	4.00 Sq. Extra Deep	450	\$49.50	\$47.00	32	4PXD	3.50	5.02	1.52 pt	43.94	PF-1040		
3497	4.50 Square	375	\$41.95	\$39.95	28	45P375	4.19	3.63	1.69 pt	48.82	PF-1045,12 or 10		
3440	4.50 Square Deep	375	\$47.55	\$45.55	28	45PD375	4.19	4.88	1.15 qt	66.64	PF-1045,12 or 10		
Black w/Label Slots, Belden Plastics							Dimensions		Volume		Compatible		
Item #	Description	Pcs/Cs	1-5 Cs	6-Skid	Skid Qty	Mfg Code	Dia.	Depth	Liquid	Cu. In.	Transport Trays		
11255	4.50 Jumbo Jr Square	375	\$70.95	\$68.95	28	691525	4.13	5.00	1.05 qt	N/A	PF-1045,12 or 10		
11256	5.25 Jumbo Square	200	\$66.95	\$64.95	40	6915150	5.25	5.25	1.71 qt	N/A	BST05		
11257	5.25 Jumbo Senior	200	\$67.95	\$65.95	40	691535	5.25	6.50	2.03 qt	N/A	BST05(fits loose)		
11258	6.00 Magnum Square	150	\$61.95	\$59.95	40	691543	6.00	6.50	2.79 qt	N/A	BST06		

Sheet of Pots



Lightweight pots in a perforated sheet, Landmark Plastics							Dimensions		Volume		Compatible
Item #	Description	Pcs/Cs	1-5 Cs	6-Skid	Skid Qty	Mfg Code	Diameter	Depth	Liquid	Cu. In.	Transport Trays
10459	3.00 Square, 32 Count	100	\$74.95	\$72.95	24	3SQSP	2.45 x 2.47	3.00	0.387 pt	11.17	LSP1030, L Series
4209	3.50 Sq. Deep, 18 Ct	100	\$84.95	\$82.95	20	35SPXD	3.48 x 3.47	3.50	0.92 pt	26.55	PF-1040, L Series
4445	4.50 Square, 15 Count	100	\$114.95	\$112.95	16	45SP	4.09 x 4.09	3.65	1.55 pt	44.85	PF-1045

Square Pot Trays



Square Pot Trays							Dimensions			Compatible
Item #	Description	Pcs/cs	1-5 Cs	6-Skid	Skid Qty	Mfg Code	Length	Width	Depth	Square Pots
4711	2.25 Sq. Pot Tray, 32 Count	100	\$83.95	\$82.95	40	2SPT32	18.10	9.12	2.25	PF-0225
3439	3.00 Sq. Pot Tray, 32 Count	100	\$92.95	\$90.95	32	LPF32TRY	21.23	10.79	1.50	PF-03, PF-030
10552	3.00 Sheet of Pots Tray, 32 Ct	100	\$93.95	\$91.95	32	3SPT32	21.23	10.79	2.00	LSP030
11259	3.25 Sq. Extra Deep Tray, 20 Ct	100	\$145.95	\$143.95	36	3PXDT20	15.19	12.19	2.00	PF-0320
3394	4.00 Sq. Pot Tray, 18 Count	100	\$89.95	\$87.95	32	LPF18TRY	21.23	10.79	2.31	PF-040, PF-0400
4446	4.50 Sq. Pot Tray, 15 Count	50	\$55.43	\$53.95	32	LPF15TRY	21.10	12.71	2.31	PF-045, PF-0450, BSP0450
11260	4.50 Sq. Pot Tray, 12 Count	100	\$125.95	\$123.95	20	L45PF12	16.97	12.75	2.31	PF-045, PF-0450, BSP0450
3523	4.50 Sq. Pot Tray, 10 Count	90	\$69.95	\$67.95	30	45SPT10	20.94	8.44	2.02	PF-045, PF-0450, BSP0450
11261	Jumbo Sq. Pot Tray, 8 Count	50	\$94.95	\$92.95	18	698140	21.25	10.90	3.25	BSP05, BSP050 fits loose
11262	Magnum Sq. Pot Tray, 6 Count	50	\$112.95	\$110.95	18	694225	18.00	12.00	3.25	BSP06

Water-Matic Trays

Reservoir holds water while elevated overflow holes ensure that excess water is drained.



Item #	Description	Pcs/cs	1-5 Cs	6-Skid	Mfg Code	Length	Width	Depth	Compatible Pots
11263	4.50 Square Tray, 15 ct 3x5	50	\$62.95	\$60.95	45SWM	21.05	12.61	2.44	PF-045, PF-0450, BSP0450
11264	4.50 Rnd/Sq, 8 Ct 2x4 spaced	100	\$124.95	\$121.95	45RSWM	20.25	10.13	2.44	See above & all 4.5" Round

Round Thermoformed Pots



Flexible sidewall with rim design that has good hoop strength.							Dimensions		Volume		Compatible
Item #	Description	Pcs/Cs	1-5 Cs	6-Skid	Skid Qty	Mfg Code	Dia.	Depth	Liquid	Cu. In.	Trays
2799	4.00 Round, Black	825	\$48.95	\$46.95	42	4RMGT	4.0"	3.49	1.02 pt	29.4	SRT040
4578	4.50 Geranium, Black	Now 450	\$37.95	\$35.95	48	45RMGT	4.5"	4.02	1.37 pt	39.7	SRT045-12
13136	4.50 Geranium, Terra-Cotta	Now 450	\$45.95	\$43.95	48	45RMGT	4.5"	4.02	1.37 pt	39.7	SRT045-12
3436	5.00 Azalea, Black	440	\$40.95	\$38.95	48	5AMGT	5.0"	3.61	1.67 pt	48.21	SRT050
3434	6.00 Azalea, Black	220	\$25.95	\$23.95	48	6AMGT	6.0"	4.38	1.40 qt	81.04	SRT060
80-0180	6.00 Azalea, Terra-Cotta	220	\$37.50	\$35.95	48	6AMGT	6.0"	4.38	1.40 qt	81.04	SRT060
11265	6.50 Azalea, Black	240	\$33.95	\$31.95	48	65AMGT	6.5"	5.00	2.08 qt	120.12	SRT065
12511	6.50 Azalea, Terra-Cotta	240	\$31.95	\$29.95	48	65AMGT	6.5"	5.00	2.08 qt	120.12	SRT065
11266	7.50 Azalea, Black	220	\$49.95	\$47.95	27	75AMGT	7.5"	5.71	3.02 qt	174.5	

Round Injection Molded Pots



AZALEA POTS

Heavy Duty, Rigid							Dimensions		Volume		Compatible
Item #	Description	Pcs/Cs	1-5 Cs	6-Skid	Skid Qty	Mfg Code	Dia.	Depth	Liquid	Cu. In.	Trays
11267	Clay 3.00 Standard	1,750	\$127.95	\$125.95	NA	Koba	3"	2.75	7.0 fl oz	12.63	SRT030
11268	Black 4.50 Geranium	900	\$98.95	\$96.95	36	IG450MG	4.5"	4.00	1.27 pt	36.74	SRT045-12
4349	Green 4.50 Geranium	900	\$102.95	\$100.95	36	IG450MG	4.5"	4.00	1.27 pt	36.74	SRT045-12
4208	Black 6.00 Azalea	252	\$59.95	\$57.95	48	IA600MP	6"	4.75	1.57 qt	90.80	SRT060
12984	Green 6.00 Azalea	252	\$62.95	\$60.95	48	IA600MP	6"	4.75	1.57 qt	90.80	SRT060
11269	Black 6.50 Azalea	260	\$75.95	\$73.95	48	IA650MP	6.5"	5.13	2.03 qt	117.20	SRT065
11047	Green 6.50 Azalea	260	\$77.95	\$75.95	48	IA650MP	6.5"	5.13	2.03 qt	117.20	SRT065
11270	Green 7.00 Azalea	264	\$91.95	\$89.95	28	Koba	7"	5.50	2.16 qt	151.62	
11271	Green 8.00 Azalea	206	\$86.95	\$84.95	18	Koba	8"	6.25	1.00 gal	231.04	
11272	Green 10.00 Azalea	36	\$31.95	\$30.95	40	Koba	10"	7.50	1.75 gal	404.32	
11273	Black 12.00 Azalea	25	\$56.95	\$55.95	42	Belden	12"	9.00	3.00 gal	0.00	

Round Pot Transport Trays



Round Pot Transport Trays			Price Per Case				Dimensions			Compatible
Item #	Description	Pcs/cs	1-5 Cs	6-Skid	Skid Qty	Mfg Code	Length	Width	Depth	Pots
11274	3.00 12 Count 3x4	146	\$125.95	\$122.95		Koba	12.00	9.00	3.00	TWP030C
2802	4.00 15 Count 3x5	85	\$108.95	\$105.95	14	4TP15PS	20.25	12.13	3.50	TWT4
11275	4.50 12 Count 3x4	75	\$94.95	\$91.95	24	45TP12	18.99	14.11	3.96	TWT45, LTW045
2803	4.50 15 Count 3x5	90	\$133.95	\$130.95	16	45TPPP	23.06	14.06	3.94	TWT45, LTW045
3425	5.00 8 Count 2x4	100	\$105.95	\$102.95	36	T5TP	20.00	10.00	3.75	TWT5
3442	6.00 6 Count 2x3	100	\$116.95	\$113.95	30	6TP	17.64	11.50	4.25	TWT6, LTW060
13355	6.50 6 Count 2x3	100	\$139.95	\$136.95	28	65TP	19.63	13.00	5.25	TWT65, LTW065

PLUG SHEETS

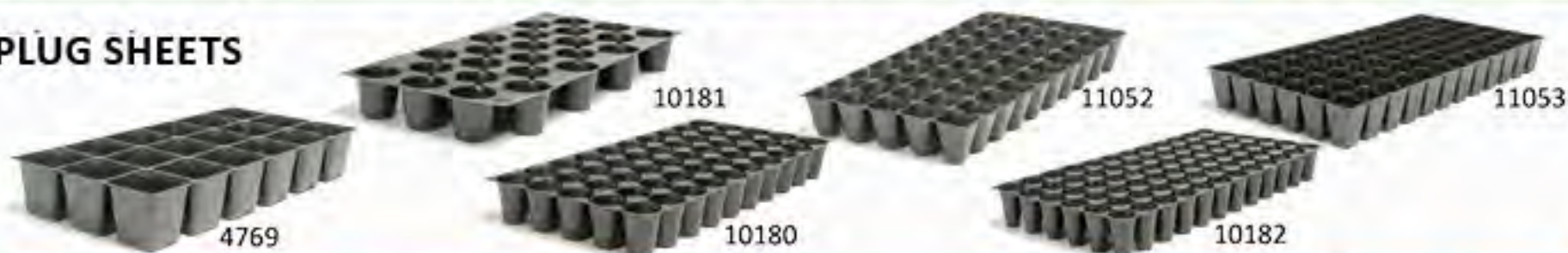

Plug Sheets (20.85" x 10.42") Standard 1020 Size (Lightweight, to use with a carrying tray)								Cell Configuration	Top Diameter	Cu. In. Per Cell
Item #	Description	Pcs/Cs	1-5 Cs	6-31 Cs	32 Cs	Mfg Code	Depth			
10181	24 Round	100	\$64.95	\$62.95		24PSD	2.75	3 x 8 Staggered	2.63	8.17
10306	38 Round	100	\$64.95	\$62.95		38PS	2.38	2@7 and 3@8	2.25	6.80
10180	50 Round	100	\$63.95	\$61.95		50PS	2.38	5 x 10	2.00	4.60
10182	72 Round	100	\$63.95	\$61.95	Ask	72PS	2.38	6 x 12	1.50	2.54
10420	98 Round	100	\$66.95	\$64.95	for	98PS	1.63	7 x 14	1.38	1.69
4769	18 SQUARE	100	\$60.95	\$58.95	price	18SPSD	3.23	3 x 6	3.16	23.42
11051	36 Rectangular	100	\$61.95	\$59.95		36SPS	2.38	4 x 9	2.31 x 2.06	7.49
11052	50 SQUARE	100	\$81.50	\$79.50		50SPS	2.38	5 x 10	1.93	5.80
11053	72 SQ. w/Root Channels	100	\$64.95	\$62.95		72SPS	2.38	6 x 12	1.63	4.09

PLUG TRAYS



Plug Flats (21.38" x 11.05") Standard 1020 Size (Heavy-duty, to use without a carrying tray)								Cell Config.	Top Diameter	Cu. In. Per Cell
Item #	Description	Pcs/Cs	1-5 Cs	6-Skid	Skid Qty	Mfg Code	Depth			
3470	50 Square	100	\$109.95	\$106.95	24	P50	2.25	5 x 10	1.75	5.19
2950	72 Square, Deep	100	\$108.95	\$105.95	32	P72SQD	2.38	6 x 12	1.63	4.45
10307	72 Round w/Vent Holes	100	\$108.95	\$105.95	32	72FPT	2.25	6 x 12	1.49	2.52
3392	98 Square	100	\$108.95	\$105.95	32	P98	2.00	7 x 14	1.25	1.92
2881	128 Square	100	\$98.95	\$95.95	32	P128	2.00	8 x 16	1.25	1.68
10284	200 Square	100	\$98.95	\$95.95	32	P200	1.75	10 x 20	0.88	1.29
3457	288 Square	100	\$108.95	\$105.95	32	P288SQ	1.00	12 x 24	0.75	0.44
10173	288 Square, Deep	100	\$108.95	\$105.95	32	P288SQD	1.75	12 x 24	0.75	0.61
11054	392 Square	100	\$109.95	\$106.95	32	P392	1.00	14 x 28	0.63	0.28
11055	406 Square	100	\$109.95	\$106.95	32	P406	1.00	14 x 29	0.63	0.28
11056	512 Square	100	\$103.95	\$100.95	20	P512	1.00	16 x 32	0.56	0.24

Hexagon Plug Flats, Standard 1020 Size (Heavy-duty, to use without a carrying tray)								Cell Config.	Top Diameter	Cu. In. Per Cell
Item #	Description	Pcs/Cs	1-5 Cs	6-Skid	Skid Qty	Mfg Code	Depth			
11057	105 w/Root Channels	100	\$98.95	\$96.00	32	105HEX	1.5	7 x 15	1.25 x 1.38	1.4

SEEDLING TRAYS



Seedling Trays (21.23" x 10.8") Standard 1020 Size (HD, to use without carrying tray)								Cell Config.	Top Dia.	Cu. In. Per Cell
Item #	Description	Pcs/Cs	1-5 Cs	6-Skid	Skid Qty	Mfg Code	Depth			
4768	30 Ct Rose pot shape w/ channels	50	\$79.95	\$77.95	32	30ST	3.50	2@8 & 2@7	2.50	10.50
3493	38 Ct Rose pot shape w/ channels	50	\$88.95	\$86.95	20	38ST	5.00	3@8 & 2@7	2.25	12.10
10423	50 Ct Octagonal w/ round bottom	55	\$95.95	\$93.95	20	50ST	4.50	5 x 10	1.88	8.80
13354	72 Ct Rose pot shape w/ channels	50	\$85.95	\$83.95	32	72ST	3.25	6 x 12	1.63	4.20

WATER BREAKERS

High quality Dramm® water breakers are made from impact resistant ABS plastic with a stainless steel face plate.



Item #	Description	Spray Pattern	Price
4664	RedHead	Soft, High Flow, Medium Pattern	\$10.50
10257	OrangeHead	Soft, High Flow, Wide Pattern	\$11.50
4901	LemonHead	Soft, Medium Flow	\$10.50
10258	Blue	Full Flow for drenching, hanging baskets, etc.	\$6.00

DRAMM® HANDI-REACH HANDLES

Standard garden hose connections.

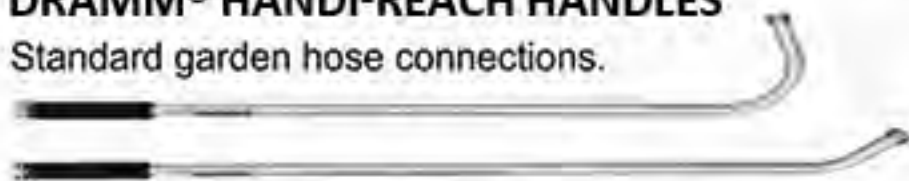

Item #	Description	Price
4671	24" Handi-Reach Handle, 45° angle	\$7.75
4665	36" Handi-Reach Handle, 45° angle	\$8.50
10259	48" Handi-Reach Handle, 45° angle	\$9.10
10260	36" Handi-Reach Handle, 90° angle for hanging baskets, etc.	\$9.10
12502	16" Handi-Reach Handle, 45° and 90° angle	\$8.00

WONDER WATER



This high quality watering wand comes complete with filter and shutoff. The laser-cut faceplate creates a very uniform soft water pattern. It comes highly recommended by our plug growers.

Item #	Description	Price	12+
4577	Wonder Waterer	\$30.50	-
10235	Replacement Face Plate	\$6.75	\$6.50
10270	Replacement Filter Screen	\$3.50	-
11159	Filter Case only	\$3.75	-

FOGG-IT NOZZLE

These fine volume misting nozzle are a great aid in watering cuttings, delicate stock and hand misting. All bronze.



Item #	Description	Price
11160	FOGG-IT nozzle, 1 gpm	\$8.50
11161	FOGG-IT nozzle, 2 gpm	\$8.50

DRAMM® REVOLVER SPRAY GUN

This heavy-duty spray nozzle has nine spray patterns which can easily be changed with the quick-click pattern changing Ergonomic insulated grip.

Item #	Description	Price
11162	Dramm® Revolver	\$9.75



DRAMM® COLORSTORM™ HOSE

Dramm ColorStorm-Professional Rubber Hose is made from EPDM rubber for a "crackless" hose cover that is resistant to abrasion and weathering. Heavy, hex shape that resists kinking.



Pre-assembled, with crimped nickel-plated ends:		
Item #	Description	Price
11163	ColorStorm Hose 3/4" x 50'	\$69.50
11164	ColorStorm Hose 3/4" x 75'	\$94.50
10440	ColorStorm Hose 3/4" x 100'	\$111.50
11165	ColorStorm Hose 5/8" x 50'	\$49.50
11166	ColorStorm Hose 5/8" x 75'	\$74.50
11167	ColorStorm Hose 5/8" x 100'	\$90.50

Bulk Hose (cut to any length):			
Item #	Description	Per Foot	Price
11168	3/4" Yellow		\$1.25
11169	ColorStorm Hose	330' Bulk Roll	\$336.00
11170	Female Crimped Hose End		\$8.50
11171	Male Crimped Hose End		\$7.00

These nickel-plated ends are installed at our vendor. You can also use **11183** (\$4.5/set) & 2=SS Hose clamps (**4108**).

ORBIT® FAN SPRAY NOSSLE

This fan nozzle features high quality plastic construction. The flow can easily be adjusted with the shut-off valve.



Item #	Description	Price
10209	Orbit® Fan Nozzle with Shut-off	\$4.75

DRAMM® LEVER ACTIVATED VALVE

Full flow (up to 11 gpm) squeeze valve with garden hose connections, FHT x MHT.



Item #	Description	Price
10188	Dramm® Lever Activated Valve	\$9.50

DRAMM® SYPHONJECT

Fertilize while you water. Garden hose connection Average dilution rate is 20:1. Requires 35 psi at faucet and 3-5 gpm flow. Full flow water breaker included (170PL).



Item #	Description	Price
11173	Dramm® Syphonject™ Siphon Mixer	\$15.00

Flower Pouches

Green plastic with loop handle. Growing in flower pouch utilizes wall space and adds appeal.

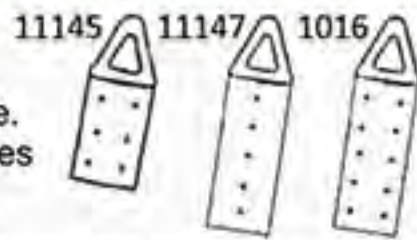

Item #	Description	Size	Volume	1-249	250+
11145	6 Slit, Al's Mini	8.5 x 13.5"	1.06 gal.	\$0.65	\$0.60
11147	5 Slit, Al's	8.5 x 21.25"	1.59 gal.	\$0.65	\$0.60
10165	10 Slit, Al's	8.5 x 21.25"	1.59 gal.	\$0.65	\$0.60
11148	8 Slit, Generation 2	8 x 20"	1.06 gal.	\$0.65	\$0.60

INSECT MONITORING CARDS

Durable, long-lasting pest monitoring and trapping cards are designed to catch a variety of pests. Non-sticky edges.

Item #	Description	Price
4532	3" x 5" Yellow Sticky Traps, 48/pack	\$24.75

GREEN-SHIELD® DISINFECTANT

Disinfectant & Algicide a biodegradable liquid concentrate for horticultural use that controls fungal, bacterial, viral plant pathogens and algae.

Corrosive
No UPS shipping!



Item #	Description	Price	4+
2715	Green-Shield® Disinfectant, 1 gallon	\$47.75	\$46.50

HUMIDITY DOMES

Clear plastic propagation domes. Fits standard 1020 size trays (see page 2).



Item #	Description	1-49	50+
2601	Standard Domes, 21 1/4" x 11" x 2 1/2"	\$1.85	\$1.60
		1-39	40+
1156	Tall Domes, 21.25" x 11" x 7"	\$4.15	\$3.90

BLACK PVC GLOVES, COTTON LINED, 12"

Item #	Description	Price/Pair	Bnd 12/Pair
11157	Black PVC Gloves	\$4.00	\$3.50ea.

WHITE VINYL BATTEN TAPE, 3/4" X 500'



ITEM NO.	PRICE
4773	\$34.95

For securing plastic film to end walls, wood frame greenhouses, cold frames, etc. Just staple every 3-4" holding tape tight. 3/4" wide by 1/32" thick, 500' roll.

AGRITAPE HEAT MAT SYSTEMS



An Agritape system consists of a control unit to regulate soil temperature, the Agritape Heat Mat, and a grounding screen. The screen serves to safely ground the current if the tape is damaged.

To install a system, roll out the Heat Mat and plug it into the control unit. Cover the Heat Mat with the ground screen. Connect the ground wire from the control unit to the screen. Plug in the control unit and place the sensor in the soil of the seed tray or container. Set to the desired soil temperature. Agritape will warm soil temperature by a maximum of 20°F (more with a humidity dome) above room temperature.

Does not work with GFCI outlets.

Electric current flows through black bars (which are a resistive/ conductive material) to create a virtually continuous heat pattern.



Control Units: (Multi-outlet power strips can be used to add mats to a controller, however, do not exceed amp rating or max amount of tape.)

Item #	Description	Price
11150	Digital Control, 1 outlet, digital thermostat. Max: 50 sq. ft. of heat mats. Rated 8.5 amps.	\$76.50
4330	AT-JR Control, 2 outlets, dial thermostat. Max: 80 sq. ft. of heat mats. Rated 13 amps.	\$133.50
10454	AT-1 Control, 4 outlets, dial thermostat. Max: 120 sq. ft. of heat mats. Rated 20 amps.	\$144.00

Heat Mats, Stock sizes: (Grounding screen included)

Item #	Description	Price
4668	11" x 4' Agritape Heat Mat	\$38.00
4327	11" x 10' Agritape Heat Mat	\$65.75
4328	22" x 10' Agritape Heat Mat	\$124.00
4329	44" x 10' Agritape Heat Mat	\$183.00

Heat Mats, Non-stock: (Shipping charge may incur.)

Item #	Description	Price
10452	11" Agritape - Custom Length (1-9 ft.)	\$8.20/ft.
11151	11" Agritape - Custom Length (10-25 ft.)	\$7.50/ft.
10453	Grounding Screen (for custom mats) 1- 6 ft. wide, any length.	\$1.25 per sq. Ft.
11152	22" x 4' Agritape Heat Mat	\$70.00
11153	22" x 8' Agritape Heat Mat	\$104.00
11154	44" x 6' Agritape Heat Mat	\$126.00
11155	44" x 8' Agritape Heat Mat	\$147.00

SA-20 DISINFECTANT

ITEM	DESCRIPTION	PRICE
4460	Similar to Greenshield.	\$34.95

Controls algae and mildew. Disinfect greenhouses, pots, tools and ornamentals.



**22" and 44" Wide
Heat Mats**



22" and 44" Wide Heat Mats *Great for large germination areas!*

Agritape Heat Mat systems are easily installed and removed, so bench space can be used for multiple purposes. The Agritape heats up when it is electrified with standard house current (110 volts AC) and will generate heat (up to 95° F) that is extremely uniform across the entire surface of the tape. The tape is rated 20 watts per square foot. Agritape Heat Mats distribute heat evenly over the entire mat surface, eliminating the cool spots typical of wire coil mats.

Easy to install a system, simply roll out heater and plug into the control unit. Cover the heater with the ground screen. Connect the ground wire from the control unit to the screen. Place seed tray or container on ground screen. Plug in the control unit and place the bulb thermostat in the soil of the seed tray or container. Set the dial to the desired soil temperature. Ambient temperature should be kept at 50° F or higher, as the Agritape will increase soil temperature by a maximum of 20° F.

Agritape Heat Mats: The 22" wide material is stocked in standard lengths of 4, 8, and 10 feet, while the 44" wide material is stocked in standard lengths of 6, 8, and 10 feet. Heat Mats come prepackaged consisting of heater and screen are available.

GREENHOUSE

GARDEN HOSE QUICK COUPLERS

These handy quick couplers are designed without a valve for maximum flow and allow water flow when disconnected.



Item #	Description	Price
10186	Brass Female Quick Coupler	\$4.90
10185	Brass Male Quick Coupler	\$2.40

GARDEN HOSE PVC ADAPTERS



Item #	Description	Price
11186	MHT x 3/4" Soc (1" Spig)	\$0.75
11187	FHT x 3/4" Soc (1" Spig)	\$2.00
11188	MHT x 1/2" Soc (3/4" Spig)	\$0.75
11189	FHT x 1/2" Soc (3/4" Spig)	\$2.00

WHITE PLASTIC LABELS & SIGNS



Item #	Description	Price
4299	4-1/2" x 1" (1,000/roll - perforated)	\$17.00
3395	4" x 5/8" (1,000/box - loose)	\$23.00
4300	5" x 5/8" (1,000/box - loose)	\$27.00
11194	7" x 5/8" loop tag (1,000/roll - perforated)	\$27.00
11195	3" x 5" Angled T-sign, 10 1/4" height, 50/cs	\$28.00
11196	2-1/2" x 4" Angled T-sign, 16" height, 50/cs	\$36.50
11197	4" x 6 1/4" Angled T-sign, 20 1/4" height, 25/cs	\$34.00
11198	Base for all angled T-signs, 25/cs	\$45.50
GGA30	Liquid Chalk Markers, 3pk-Red, Green, Blue	\$37.00

PERMANENT MARKERS

Garden Marker: Fast drying, waterproof pen that contain filters for maximum fade resistance. Alcohol-based ink. Xylene free.



Item #	Description	Price	Quantity	Price
10442	Black Garden Marker	\$2.25	25+	\$2.00

STRIP-IT BY PACE 49, 2.5 GALLON



ITEM NO.	PRICE
10715	\$190.00

Strip-It is a heavy duty acid-based phosphate-free cleaner. Strip-It is a specialty formula that quickly penetrates and removes algae, fertilizer build-up, calcium, hard water deposits, and greenhouse whitewash coatings without brushing. It removes all common soils found in and around greenhouses, irrigation systems, grower structures, and is especially useful during crop rotation.

STRIKE 50 WDG



ITEM NO.	PRICE
2780	\$85.00

A greenhouse and nursery systematic fungicide that controls certain diseases on flowers, foliage plants, shrubs, and shade trees in commercial nurseries, garden centers, and greenhouses.

HORMODIN 1, 1 LB



ITEM NO.	PRICE
3405	\$19.95

Hormodin 1 is a general purpose powder designed for the home gardener or commercial florist who propagates popular varieties such as roses, carnations, poinsettias, some species of shrubs, and most home, garden, and greenhouse plants. One pound of Hormodin 1 will treat at least 35,000 average cuttings.

HURRICANE WDG FUNGICIDE, 8OZ BOTTLE



ITEM NO.	PRICE
2682	\$115.00

A water dispersible granule formulation that is easy to measure, mix, and apply on plants. It helps protect young roots and stems from getting and developing diseases that may harm the plants for good. The Hurricane is an effective fungicide option that's premixed with two modes of action, both contact and systematic activity against a wide range of root and stem diseases.

MALICE 75 WSP



ITEM NO.	PRICE
2786	\$39.25

Malice 75 WSP is a water soluble powder formulation that provides preventative protection from early pest infestations.

GREENHOUSE



MEDALLION SC FUNGICIDE, 8 X 1OZ.

ITEM NO.	PRICE
3445	\$148.00

It's naturally occurring active ingredient (fludioxonil) explodes fungal spores on the leaf, in the thatch and beneath the soil surface. The suspension concentrate formulation delivers the same reliable broad-spectrum control of several key turf diseases including snow mold, anthracnose and bentgrass deadspot.

EAGLE 20EW, 1 PT



ITEM NO.	PRICE
3003	\$44.75

Specialty fungicide provides excellent control of a wide variety of lawn and turf diseases including dollar spot and brown patch and is labeled for use on major turf varieties, landscape ornamentals, and backyard fruit trees and vines.

PYLON 1 PT



ITEM NO.	PRICE
3146	\$460.00

A cost-effective broad-spectrum product that provides exceptional control of key greenhouse pests. A registered product in the pyrroles class of chemistry with control of a range of insects and mites, caterpillars and Western flower and chilli thrips on ornamental plants. Controls the target insect or mite by interfering with energy production of the pests. Its trans laminar movement and mode of action result in mortality of most pests in 72 hours.

MARATHON 1% G (5 LB)



ITEM NO.	PRICE
2872	\$87.50

Marathon 1% G is a highly-active insecticide that demonstrates systematic activity in plants when applied to the soil surface or incorporated into the media. It offers up to 12 weeks of residual control on ornamental plants grown in the greenhouse or nursery.

PERLITE SUPER COARSE (6 CU FT)



ITEM NO.	PRICE
2867	\$23.15

Perlite is a unique volcanic mineral which expands from four to twenty times its original volume. When expanded, each granular, snow-white particle of perlite is sterile with a neutral pH and contains many tiny, closed cells or bubbles. The surface of each particle is covered with tiny cavities which provide an extremely large surface area. These surfaces hold moisture and nutrients and make them available to plant roots. Perlite is sterile, it is free of disease, seeds, and insects.

DISCUS NG (1 GALLON)



ITEM NO.	PRICE
3086	\$250.00

An effective insecticide that offers systematic control on ornamentals, interior plantscapes, non-bearing fruit and nut trees, in the greenhouse and in field and container nurseries. It contains Imidacloprid and Cyfluthrin as its active ingredients which offers a quick knockdown and a long term residual web used as a drench or spray. It can be used for broadcast or banded field applications to help control white grub larvae from Japanese beetles, Oriental beetles, and other insect pests as well as drench or foliar applications in the greenhouse for controlling pests such as mealybugs, aphids, and whiteflies. May also be utilized through chemigation systems.

EPSOM SALT MAGNESIUM SULFATE - OMRI (55 LB)



ITEM NO.	PRICE
3517	\$18.25

Epsom salt or magnesium sulfate is used where magnesium deficiencies occur in alkaline conditions, where a dolomitic lime application is inappropriate. Epsom salt is readily soluble in water.

VERMICULITE



ITEM	PRICE
10334 #3A (FINE), 20 LBS	\$16.50
2868 #A3 6'CF (MEDIUM), 23 LBS	\$29.50
2869 #D3 6'CF (FINE), 23 LBS	\$25.85
2922 #A4 6'CF (COARSE), 23LBS	\$29.50

Vermiculite improves soil aeration while retaining the moisture and nutrients necessary to feed roots, cuttings, and seeds for faster growth. Vermiculite possesses cation exchange properties, it can hold and make available to the growing plant ammonium, potassium, calcium, and magnesium. It is lightweight and easy to handle and mixes well with soil, peat, composted pine bark, and other composted organic materials, fertilizers, pesticides, and herbicides.

PROFESSIONAL LEADERSHIP

Developed by professional horticulturists and produced under the industry's highest quality standards, we offer over 100 professional products



Peat-Based Mixes

Sunshine Mix #1

Contains: Canadian Sphagnum Peat Moss, Perlite, Dolomitic Limestone, Long-lasting Wetting Agent, RESILIENCE®



Available sizes: SunTower 110 cu ft (1/pallet), loosefill totes (2/pallet), Big Shot 55 cu ft (2/pallet), 3.8 cu ft (30/pallet), 2.8 cu ft loosefill (51-54/pallet)

Sunshine Mix #15

Contains: Canadian Sphagnum Peat Moss, Perlite, Dolomitic Limestone, Long-lasting Wetting Agent, RESILIENCE®



Available sizes: SunTower 110 cu ft (1/pallet), loosefill totes (2/pallet), Big Shot 55 cu ft (2/pallet), 3.8 cu ft (30/pallet), 2.8 cu ft loosefill (51-54/pallet)



NEW

Perlite-Free Growing Mix

Sunshine Mix PF

Contains: Canadian Sphagnum Peat Moss, Natural Peatland Aggregate.



Available sizes: currently available in 110 CFC, planned size 2.8 CF (loosefill); 3.8 CFC bale



Bark-Based Mixes

Metro-Mix 830

Contains: Canadian Sphagnum Peat Moss, Bark, Perlite, Dolomitic Limestone, Wetting Agent, RESILIENCE®



Available sizes: 60 cu ft loosefill (2/pallet), 2.8 cu ft loosefill (48 pallet)

Metro-Mix 852

Contains: Canadian Sphagnum Peat Moss, Perlite, Bark, Vermiculite, Dolomitic Limestone, Long-lasting Wetting Agent, RESILIENCE®



Available sizes: 60 cu ft bulk bag (2/pallet), 2.8 cu ft bags (42/pallet)

GREENHOUSE



sungro
HORTICULTURE

Our Expertise is Growing®

SUNSHINE MIX

ITEM	DESCRIPTION	SIZE	PRICE
12884	#1	2.8 cu ft loose	\$14.95
13096	#1 N&O	3.8 cu ft bale	\$29.95
12885	#4	2.8 cu ft loose	\$16.75
12886	#5	2.8 cu ft loose	\$16.75
12882	#5	3.8 cu ft bale	\$27.00
13105	#8/Fafard #2	2.8 cu ft loose	\$15.95
12880	#8	3.8 cu ft bale	\$26.50
12883	#15	2.8 cu ft loose	\$13.95
12881	#15	3.8 cu ft bale	\$24.50
13109	Peat Moss White Grade	3.8 cu ft bale	\$13.50
13110	Organic Peat Moss	3.8 cu ft bale	\$14.95

METRO MIX

ITEM	DESCRIPTION	SIZE	PRICE
12971	865 Rsi	2.8 cu ft loose	\$14.50
13051	560 Suncoir Rsi	2.8 cu ft loose	\$18.00
TBD	250/Sunshine VP Mix	2.8 cu ft loose	
13386	360 Suncoir Rsi	2.8 cu ft loose	\$18.00

FAFARD

ITEM	DESCRIPTION	SIZE	PRICE
13364	Fafard Ultra Outdoor Mix	1 cu ft loose	\$4.95
13366	Fafard Ultra Container Mix	1 cu ft loose	\$5.95
13365	Fafard Ultra Container Mix	2 cu ft loose	\$9.95
13367	Fafard Garden Manure Blend	1 cu ft loose	\$6.95

**WE ARE CONSTANTLY ADDING
ITEMS TO OUR INVENTORY.**

**PLEASE CALL OR EMAIL
IF YOU DON'T SEE
SOMETHING YOU NEED.**

**CALL FOR PALLET OR
TRUCKLOAD DISCOUNTS.**

ATTENTION GROWERS:

Do you sell direct to consumer?
Are you based in Southeastern Mass?

If so, make sure your free SEMAP Local
Food Guide listing is up to date.

Update your farm's information at:
www.semaponline.org/guide

Based in another area of Mass?
Find your buy local initiative at:
www.localfoodma.org

Best wishes on a fruitful season,
Southeastern Massachusetts
Agricultural Partnership



PRO-MIX®

NOTHING SAYS GROWING MEDIA BETTER™

PRO-MIX ORGANIC VEGETABLE & HERB MIX, 2 CU FT



ITEM	PRICE
3189 54 per skid	\$1095

With MYCOACTIVE technology to stimulate vigorous growth for greater stress resistance, larger root system for increased nutrients, water uptake, bigger, healthier plants. Organic fertilizer that gradually feeds plants for up to 3 months. OMRI-Listed for use in organic gardening.

PRO-MIX PGX WITH BIOFUNGICIDE, 2.8 CU FT



ITEM	PRICE
10332 Pro-Mix PGX w/ Biofungicide, 2.8 cu ft - 57/skid	\$20.75

This fine grind mix is designed for plug growing and germination. Requires less frequent watering than peat/perlite plug mixes. Seedling rootball holds together better at transplanting than peat/perlite germination mixes. Biofungicide protects against damping-off, crown and root rot caused by Fusarium, Pythium and Rhizoctonia, enhances germination, increases plant growth, reduces risk of pathogens developing resistance to chemical fungicides, and ensures a broad spectrum of action against diseases.

PRO-MIX BX WITH MYCORRHIZAE



ITEM	PRICE
3200 PRO MIX BX W/ MYCORRHIZAE, 3.8 CFT, 30 per skid	\$26.25
4570 PRO MIX BX W/ MYCORRHIZAE, 2.8 CFTL, 57 per skid	\$13.75

Pro-Mix BX is a solution for growers seeking to benefit from both the nutrient retention ability of vermiculite and a perlite content providing limited but proper drainage capacities. Combined with high-quality fibrous peat moss, this formulation is ideal for growers looking for a general purpose medium which creates a well-balanced growing environment. Mycorrhizae improves fertilizer uptake and reduces fertilizer costs, increases the resistance of plant to stresses and reduces maintenance costs, and optimizes results without changing growing practices.

PRO-MIX PEAT MOSS, ORGANIC



ITEM	PRICE
10263 3.8 cu ft bale	\$11.30

Pro Moss "HORT" Sphagnum peat moss. OMRI-Listed for organic use.

PRO-MIX BX WITH BIOFUNGICIDE & MYCORRHIZAE, ORGANIC



ITEM	PRICE
3190 2.8 cu ft, 57 per skid	\$12.30
3190 3.8 cu ft, 30 per skid	\$28.10

A general purpose peat-based growing mix. Contains starter nutrients and is pH adjusted. Contains biofungicide and mycorrhizae.

PRO-MIX BRK ORIGINAL 2.8 CU FT



ITEM	PRICE
10275 PRO-MIX BRK ORIGINAL 2.8 CUFT, 48 PER SKID	\$13.75

In this peat/bark mix the processed pine bark adds weight and reduces water retention of media while sphagnum peat moss ensures the optimal balance between air and water. Better resistance to compaction and better container stability.

PRO-MIX BX



ITEM	PRICE
3191 2.8 cu ft, 57 per skid	\$12.34
3201 3.8 cu ft, 30 per skid	\$28.44

Pro-Mix BX is a solution for growers seeking to benefit from both the nutrient retention ability of vermiculite and a perlite content providing limited but proper drainage capacities. Combined with high-quality fibrous peat moss, this formulation is ideal for growers looking for a general purpose medium which creates a well-balanced growing environment.



Call for Full Pallet & Truckload Discounts.

BERGER PEAT MOSS PROFESSIONAL 3.8 CU FT



ITEM		PRICE
2963	30 per skid	\$12.35

This all-purpose sphagnum peat moss can be used for soil conditioning or in the preparation of balanced growing mixes.

BERGER BM6 GENERAL PURPOSE (PERLITE ONLY)



ITEM		PRICE
2593	3.8CFT, 30 per skid	\$18.95
2880	3 CFTL, 54 per skid	\$10.35

The classic peat perlite growing media manufactured exclusively with superior ingredients under stringent quality control specifications. Provides good drainage, maintains a moderate water content between irrigations, and contains carefully sieved horticultural perlite.

BERGER BM1 GENERAL PURPOSE



ITEM		PRICE
2591	3 CFTL, 54 per skid	\$10.75
2592	3.8 CFT, 30 per skid	\$19.95

High-quality sphagnum peat moss and vermiculite provides additional nutrient retention in root rhizosphere between irrigation and optimal moisture retention for late spring and summer crops.

BERGER BM8 COARSE PEAT MOSS, WATER SAVING



ITEM		PRICE
4206	C3CFTL, 54 per skid	\$11.35
4241	3.8 CFT, 30 per skid	\$21.00

With the addition of our professional grade composted peat moss, this mix is specifically designed to enhance water retention between irrigations and provide extra nutrients. Increased cation exchange capacity, presence of beneficial microorganisms.

BERGER BM2 SEED GERMINATION



ITEM		PRICE
2750	3 CFTL, 54 per skid	\$12.85



General purpose high-quality plug mix for unmatched uniformity during seed germination and seedling production. Optimized aeration and water retention, reduced weight for increased volume per shipment.



ALSO SEE PAGE 24 FOR VERMONT COMPOST COMPANY PRODUCTS.
CALL FOR FULL PALLET & TRUCKLOAD DISCOUNTS.

IRRIGATION

COMMERCIAL/FARM 3/4" KINK FREE HOSE



ITEM	SIZE	PRICE
3510	3/4" x 50'	\$46.99
3511	3/4" x 75'	\$57.99
4305	3/4" x 100'	\$71.99

High performance lead-free brass couplings, drinking water safe, phthalate Safe. Kink free Duraflow technology. High performance burst - 600 psi.

MELNOR HEAVY DUTY ALL METAL HOSE REPAIR - 3/4"



ITEM	FITTING	PRICE
3722	Male	\$3.49
3723	Female	\$3.99
3724	Inline	\$4.49

MELNOR METAL HOSE NOZZLES



ITEM	DESCRIPTION	PRICE
3715	Sweeper Nozzle	\$2.99
3716	Mist to Jet	\$2.99
3717	Mist to Jet with Grip	\$3.99

TEFLON TAPE



ITEM NO.	PRICE
2653	\$0.95

TEFLON TAPE. Plumber's tape wraps easily around threads to seal pipe connections, self lubricates joints for easy assembly, stretches up to 50%, withstands harsh temperatures, PTFE never dries out.

DRAMM HANDI-REACH HANDLE 24" 45° ANGLE



ITEM NO.	PRICE
4671	\$8.06

HANDI-TECH EXT HANDLE - 24". Eliminates stretching and stooping, has a molded rubber grip for comfort.

DRAMM HANDI-REACH HANDLE 36" 45° ANGLE



ITEM NO.	PRICE
4665	\$8.84

HANDI-TECH EXT HANDLE - 36". Eliminates stretching and stooping, has a molded rubber grip for comfort.



LEADING PRODUCERS OF LAWN & GARDEN WATERING PRODUCTS IN NORTH AMERICA

MELNOR METAL HOSE SHUT-OFF



ITEM NO.	PRICE
3726	\$4.99

SINGLE METAL HOSE SHUT-OFF.

MELNOR METAL HOSE CONNECTORS WITH BUILT IN SHUT OFF VALVES



ITEM NO.	TYPE	PRICE
3725	Two-way	\$7.99
3727	Four-way	\$17.99

Connect up to 4 hoses to 1 faucet, with a free-spinning coupling nut. Each outlet is individually controlled. Made of solid metal construction and fits standard garden hose threads.

Aqua-Traxx[®]

with the **PBX Advantage**



AQUA-TRAXX DRIP IRRIGATION TAPE

NAME	ITEM	SECONDARY #	DESCRIPTION	PRICE
.45 GPM/100' 12" Spacing				
	10432	AQ-15	15 MIL 4000'	\$151.88
	2985	AQ-10	10 MIL 6000'	\$150.84
	2986	AQ-08	8 MIL 7500'	\$147.72
	10012	AQ-06	6 MIL 10,000'	\$168.52
.34 GPM/100' 12" Spacing				
	3925	AQ-101	0 MIL 6000'	\$150.84
	2987	AQ-081	8 MIL 7500'	\$147.72
.22 GPM/100' 12" Spacing				
	4456	AQ-081222	8 MIL 7500'	\$147.72
	12404	AQ-061222	6 MIL 10,000'	\$168.52
0.50 GPM/100' 8" Spacing				
	4960	AQ-083	8 MIL 7500'	\$147.72
0.67 GPM/100' 6" Spacing				
	3644	AQ-080667	8 MIL 7500'	\$147.72
1.34 GPM/100' 4" Spacing				
	11782	AQ-0804134	8 MIL 7500'	\$147.72
0.25 GPM/100' 16" Spacing				
	12400	AQ-082	8 MIL 7500'	\$147.72
0.17 GPM/100' 16" Spacing				
	12401	AQ-061617	6 MIL 10,000'	\$168.52

AQUA-TRAXX DRIP IRRIGATION TAPE WITH THE PBX ADVANTAGE

NAME	ITEM	SECONDARY #	DESCRIPTION	PRICE
Flow Control .45 GPM/100' 12" Spacing				
	12008	APC08	8 MIL 7500'	\$164.32
	10174	APC10	10 MIL 6000'	\$168.48
Flow Control 0.34 GPM/100' 12" Spacing				
	12405	APC081	8 MIL 7500'	\$164.32
	12058	APC101	10 MIL 6000'	\$168.48
Flow Control 0.25 GPM/100' 16" Spacing				
	12406	APC102	10 MIL 6000'	\$168.48
Flow Control 0.22 GPM/100' 12" Spacing				
	4960	APC101222	10 MIL 6000'	\$168.48

DEDUCT \$5.00 PER ROLL FOR 10+ ROLLS

CHAPIN DRIP IRRIGATION TAPE

ITEM NAME	ITEM NO.	SECONDARY NO.	DESCRIPTION	PRICE
.45 GPM/100' 12" Spacing				
	2891	CH-154	15 MIL 4000'	\$152.88
	12395	CH-106	10 MIL 6000'	\$151.84
	12396	CH-103	10 MIL 3000'	\$81.12
	11865	CH-087	8 MIL 7500'	\$148.72
	12397	CH-0610	6 MIL 10,000'	\$168.48
1.0 GPM/100' 4" Spacing				
	5096	CH-103041	10 MIL 3000'	\$85.80
	3590	CH-101041	10 MIL 1000'	\$43.68
0.50 GPM/100' 8" Spacing				
	12398	CH-08708050	8 MIL 7500'	\$148.72
0.50 GPM/100' 18" Spacing				
	12399	CH-08718050	8 MIL 7500'	\$156.00

DRIP TAPE FITTINGS

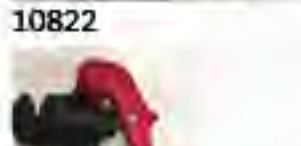

ITEM.	SECONDARY NO.	DESCRIPTION	PRICE
BARB X TAPE LOC ADAPTER			
2988	DTF250B	0.25" BARB	\$0.42
2989	DTF400B	0.40" BARB	\$0.42
BARB X TAPE LOC ADAPTER WITH VALVE			
3598	DTF250BV	.25" BARB - BLUE VALVE	\$1.56
4089	DTF400BV	.42" BARB - BLUE VALVE	\$1.51
3922	DTF425BV	.425" BARB - YELLOW VALVE	\$1.51
2990	DTF420BV	.42" BARB - RED VALVE	\$1.56
DRIP TAPE END PIECES			
2991	DTFCAP	DRIP TAPE END SLEEVE	\$0.11
5003	DTFEND	TAPE LOC END PLUG WITH RING	\$1.61
TAPE LOC PIECES			
2992	DTFCPT	TAPE LOC COUPLING	\$0.47
10821	DTFCPTBV	TAPE LOC COUPLING WITH VALVE	\$1.61
3928	DTFELL	TAPE LOC ELL	\$1.51
12388	DTFFCH	TAPE LOC X AUTOMATIC FLUSH END	\$1.35
3828	DTFFHC	TAPE LOC x LAYFLAT ADAPTER	\$0.78
3830	DTFHEX	INSTALLATION TOOL FOR ITEM 3828 ABOVE	\$5.20
3829	DTFFHCBV	TAPE LOC x LAYFLAT ADAPTER WITH VALVE	\$1.51
2993	DTFFHS	TAPE LOC x FEMALE HOSE SWIVEL	\$1.40
2994	DTFMA	1/2" MPT TAPE LOC x MALE THREAD ADAPTER	\$0.62
2995	DTFMHT	MHT TAPE LOC x MALE THREAD ADAPTER	\$0.52
12402	DTFSSP	TAPE LOC x 1.2" SOC ADAPTER	\$0.68
3926	DTFTEE	TAPE LOC TEE	\$1.40
10806	DTF400PIAG	.40" BARB x 1/4" FIPT GAUGE ADAPTER	\$1.56
12409	DTF400PIA	.40" BARB X 1/2" SOC ADAPTER	\$0.52
MISTAKE & GOOF PLUGS			
4376	DTFMP400	Mistake Plugs for .420" holes	\$0.31
5158	OTFMP1	Goof Plugs for 1/8" to 1/4" holes - 10 pack	\$0.52
BARB to BARB COUPLINGS			
10822	TB-250	1/4" Barb to Barb Couplings	\$0.17
10823	TB-400	3/8" Barb to Barb Couplings	\$0.25
PUNCHES FOR OVAL HOSE & TUBING			
3927	DTFACT400	Serrated Insertion Punch for 3989 & 4089	\$24.75
10691	DTFAP02	Ejector Punch: Drippers 1/8" & 3/16" Barbs	\$8.95
10837	DTFAP03	Ejector Punch: COT1, Fittings with .25" Barbs	\$8.95
4961	DTFAP07	Ejector Punch: Fittings with .4/.42/.425 Barbs	\$8.95
10177	DTFDP400S	Red Deluxe Serrated Punch for .4" or .41" Barbs	\$25.95
10824	DTFFHP2	Layflat Punch for tape fittings	\$57.95

INTRODUCING SCOUT

The next generation of drones



Commercial release in 2020.

Visit our website for more info



SCOUT | THE FULLY-AUTOMATED DRONE SYSTEM

WHAT IT DOES

Your personal robotic scout: Once installed, Scout systems remain in your fields indefinitely, performing daily scouting missions and sending health reports to your tablet, smartphone, or PC. Scout drones live, charge, and analyze crop data within the weatherproof ScoutBase. Scout delivers truly on-demand, uniquely customizable multispectral image data to growers, agronomists, and retailers on a routine, daily basis.



ABOUT AMERICAN ROBOTICS

American Robotics is a Marlborough, MA based industrial drone developer specializing in Precision Agriculture. Through innovations in robot autonomy, machine vision, edge computing, and AI, American Robotics has created the next generation in drone technology: Scout™ - a fully-automated drone system capable of continuous, unattended operation.

Ultra-high resolutions.

Daily imaging.

THIS IS HOW DRONES WERE MEANT TO WORK

www.american-robotics.com

FARM SUPPLIES

AMES TRUE TEMPER LANDSCAPER WHEELBARROW (8 CUBIC FOOT CAPACITY)



ITEM NO.	PRICE
1902	\$144.99

Heavy-duty, corrosion-proof poly tray with front tray braces, cross braces and shoes. H brace. Two 16 inch wheel assemblies with pneumatic tubed 2-ply tires with oilube bearings.

GOOD IDEAS EZ COMPOSTER JR (7 CUBIC FOOT CAPACITY)



ITEM NO.	PRICE
10728	\$199.99

Black composter sits on a wheeled base for effortless turning and mixing of the compost. Recessed handles for easy turning and a large twist lid for easy but secure access makes this pet,

child, and pest proof. Black color holds heat and accelerates composting action. Base holds compost tea. Fully assembled, made in the USA of 98% post industrial recycled polyethylene.



TARTER 6 BAR ECONOMY GALVANIZED TUBE GATE

ITEM	MEASURES	PRICE
3684	12 FT. Galvanized Tube Gate	\$123.49
3683	8 FT. Galvanized Tube Gate	\$87.99

Tarter's Economy Galvanized Tube Gate has the quality, features and durable value you've come to expect from Tarter. This gate is perfect for placement at construction sites, for crowd control, or for fencing pastures, orchards, and gardens. 50 high with vertical Z-braces, this gate is made from 1-3/4 round high-tensile strength galvanized tubing with superior continuous-welded saddle joints. Gates come with hinges, hinge pins and 22 snap chain. ALSO AVAILABLE IN 10' AND 14' LENGTHS.

SOUTHERN STATES FENCE CHARGERS



ITEM	DESCRIPTION	PRICE
3207	Electric Fence Charger 110-120 volt. 50 mile range. Power surge protection.	\$169.99
3206	Electric Fence Charger 110-120 volt. 30 mile range ideal for medium to large pastures. For indoor installation.	\$149.99
3205	Solar Fence Charger Solar charged, sealed 6 volt battery. Charges up to 25 miles of fence. Will operate for 21 days in total darkness.	\$219.99

DARE PRODUCTS WESTERN SET-EZE POST WITH INSULATORS, CT 20



ITEM NO.	PRICE
10793	\$94.99

Post is 3/8 inch diameter x 54 inch length steel rod post with two Western Insulators. Wrap around anchor plate. Painted orange. 20 posts to carton.

DARE PRODUCTS STEP-IN POLY POSTS



ITEM	DESCRIPTION	PRICE
3208	BLACK - 48"	\$2.89
3209	WHITE - 48"	\$2.49

Dare Step-In Poly Post Black. Ideal for temporary electric fencing such as controlled grazing/pasture management. Lightweight, self-insulating, and convenient to use. Strong H section post molded of UV resistant polypropylene. Eight wire holders for steel wire, poly wire and poly tape up to 1 inch wide.

DARE PRODUCTS POST TOPPER FENCE INSULATORS



ITEM.	DESCRIPTION	PACK	PRICE
3211	T-Post Topper <i>Fits all T-Posts and can be nailed on top of wood posts.</i>	10-pk	\$8.79
3212	Pinlock Insulator <i>For T-Posts and chain-link fence. Fits 1.25 & 1.33 lb./ft. posts. Heavy cross sections withstand pressure of high tensile fencing. Large flange prevents shorts and arcing.</i>	25-pk	\$8.79
3213	Plastic Insulator <i>Fits 1/4 inch to 9/16 inch diameter posts and 5/8 inch fiberglass T-posts. Extends wire 1 inch from post. Installs without tools.</i>	25-pk	\$5.49
3214	Tubular Corner/End <i>Insulation for 90 turns or end loops on any style. Heavy sidewalls provide extra protection against shorts or grounds.</i>	10-pk	\$13.49
3246	Pinlock Insulator <i>(Not shown) For wood posts. Black. Heavy cross sections. Attached pin locks and unlocks fence wire.</i>	10-pk	\$10.99

FARM SUPPLIES

DARE PRODUCTS ALUMINUM ELECTRIC FENCE WIRE 16 GA 1320 FT



ITEM NO.	PRICE
3216	\$37.99

Aluminum electric fence wire is four times more conductive than galvanized steel and more visible. Lightweight and easy to install. Guaranteed against rust. Do not use with a weed burner style of charger. Recommended for use with a low impedance type Energizer.

DARE PRODUCTS POLY EQUI-ROPE WHITE 6MM X 600FT



ITEM NO.	PRICE
3217	\$81.99

Braided HD polyethylene rope with 7 strands of stainless steel wire. 15/64 inch approximate diameter. Average breaking strength 1,100 pounds. 2 spools per carton.

DARE PRODUCTS POLYTAPE WHITE 1.5 IN WIDE X 656 FT



ITEM NO.	PRICE
3218	\$99.99

Heavy Duty Poly tape woven of white UV resistant polyethylene and 15 strands of heavy duty stainless steel conductor wires. Install with tape insulators only. Highly visible, lightweight, and easy to use.

DARE PRODUCTS DIE CAST ZINC GROUND CLAMP



ITEM NO.	PRICE
3215	\$2.49

Fits 1/2 inch - 1 inch diameter ground rod. Used to connect ground wire to the ground rod. Individually blister packed.

CMC STEEL T-POST, GREEN



ITEM	MEASURES	PRICE
12458	1.25 T-POST - 5'	\$5.56
12459	1.25 T-POST - 6'	\$5.68
4818	1.25 T-POST - 6.5'	\$6.39
12460	1.25 T-POST - 7'	\$8.36
4819	1.25 METAL T-POST - 8'	\$6.79

Available in lengths of 5 ft. to 10 ft., in 6 inch increments and in weights of 1.25 lb./ft. and 1.33 lb./ft. Finished with a high gloss green enamel with silver tip or hot dipped galvanized per ASTM 123 (2 ounces/square ft.). Each post is furnished with 5 wire clips used to fasten the fence or wire to the post.

DARE PRODUCTS RUBBER GATE HANDLE



ITEM NO.	PRICE
3210	\$2.49

Soft pliable rubber outer case internally reinforced with semi-rigid, non-conductive vinyl inner tube. This provides a firm grip and acts as an extra layer of insulation. Generous, sensibly spaced flanges allow plenty of hand room. Large, heavy stamped steel plated safety hook. Enclosed spring stretches 3 1/2 to keep wire taut.

DARE PRODUCTS, OLD FAITHFUL PLASTIC GATE HANDLE RED



ITEM NO.	PRICE
3244	\$2.49

High quality, hi-impact styrene insures long and trouble-free life. Measures 4 inch between flanges. All metal parts are plated. Heavy stamped steel hook. Enclosed spring stretches 3 inches to keep wire taut.

ELECTRIC FENCE

ITEM	DESCRIPTION	PRICE
3216	Electric Fence Dare Wire, 16 ga, 1320 ft	\$37.99
3217	Electric Fence Dare Poly, 6 mm, 600 ft	\$81.99
3218	Electric Fence Dare Poly, 1.5 in, 656 ft	\$99.99

GARDEN ZONE U-POSTS



ITEM	MEASURES	PRICE
3756	HEAVY DUTY LUG U-POST - 5FT	\$9.49
3757	HEAVY DUTY LUG U-POST - 6FT	\$11.99

Heavy duty Steel U-Channel fence posts with lugs to attach fencing products, saddle joints.

ITEM	MEASURES	PRICE
3758	LIGHT DUTY U POST - 4FT	\$6.49
3759	LIGHT DUTY U POST- 5FT	\$7.79

Green vinyl coated steel. Sturdy fence-to-post anchoring clips. Spade is double riveted for maximum strength.



FARM SUPPLIES

PICKING BASKETS

The original picking basket. Long term durability. Smooth rounded edges to prevent fruit and vegetable bruising.



	PC-06	PC-05
Capacity:	5/8 Bushel	1/2 Bushel
Diameter (OD):	15.5"	14.5"
Height:	13.25"	12.25"
Material:	Polyethylene, UV Stabilized, FDA approved	
Drainage:	Ventilated bottom and sides	
Storage:	Nests for storage	
Weight:	1.76 Lb.	1.16 Lb.

Item #	Description	1-99	100-Skid	Skid Qty
5041	5/8 Bushel Green Basket	\$7.90	\$7.25	496 call
PC-05	1/2 Bushel Red Basket	\$6.75	\$6.35	696 call

METAL BASKET HANDLE (Pictured on red basket below)

This metal basket handle is designed for both 5/8 or 1/2 bushel baskets. Unique design grabs and releases

Item #	Description	Price
PCH	Metal Basket Handle	\$31.00

HD PICKING BASKET

Same size as the 5/8 bu. green basket above, but it is heavier duty and has **no** vents or drain holes. Smooth

Capacity:	5/8 Bushel
Diameter (ID):	13.75"
Height:	13"
Weight:	2.2 Lb.
Storage:	Nests for storage
Drainage:	Solid sides & bottom



Item #	Description	1-99	100+
5021	5/8 Bushel Red Basket	\$8.95	\$8.40

PIK-AID CART

A great back saver. No more dragging along heavy baskets with tomatoes, etc. or having mud collect on bottom of baskets. Carries up to 30 empty 5/8 bu. baskets or 5 gallon buckets. 10" flat-free foam-filled



Baskets not included.

\$106.95

ALL PURPOSE BASKET 1.25 BUSHEL

This all-purpose basket is the original design durable and dependable.



Capacity:	1.25 Bushel
Weight:	3.5 Lb.
Dimensions:	D 19.1" x H 17"
Storage:	Nests for storage
Drainage:	Ventilated sides & bottom

Item #	Description	1-24	25-Skid
3803	All Purpose, 1.25 Bushel	\$16.25	\$15.80
11815	Replacement Handle	\$2.29	—

ALL PURPOSE BASKET 1 BUSHEL

- Four handles for easy transfers from one person to the next.
- Handles integrated in the basket allow for tight stacking



(1" stacking height).

- Concave sides for comfortable carrying even when heavily loaded.
- Design allows for tight nesting reducing unused space.
- Flexible polyethylene with



Capacity:	1 Bushel
Dimensions:	L 19.5" x W 16.5" x H 15.5"
Weight:	4 Lb.
Storage:	Nests for storage
Drainage:	Vented sides & bottom

Item #	Description	1-24	25-Skid
10414	All Purpose, 1 Bushel	\$10.65	\$9.95

DON'T FORGET TO CHECK OUT OUR EQUIPMENT SECTION ON PAGE 23

General Purpose Container, 1.75 Bu.



Ideal for harvesting, storing

Capacity:	1.75 Bushel (75 to 80 Lb.)
Dimensions (OD):	L 23.5" x W 18.5" x H 12.25"
Material:	Polyethylene, UV Stabilized, FDA approved
Weight:	5.6 Lb.
Storage:	(Half turn) Stack to Nest
Drainage:	Ventilated Bottom and Sides

Item #	Description	1-24	25+
4145	Green 1.75 Bu. Container	\$17.50	\$16.90
PC-175R	Red 1.75 Bu. Container	\$16.85	\$16.25

MacroTote 9-FV



This 1/2 bushel tote is a ideal picking container for orchards. 16 fit within the MacroBin 32FV Smooth rounded corners.

Capacity:	1/2 Bushel	Storage:	(Half turn) Stack to Nest
Weight:	1.9 Lb.	Drainage:	Vented Sides & Bottom
Material:	UV-resistant	Dimensions:	17" L x 11" W x 8.5" H

Item #	Description	1-24	25-Skid
PC-9FV	MacroTote 9FV	\$9.95	\$9.65

Utility Box, 1.22 Bushel

Ideal for harvesting, transporting and storing small fruits & vegetable:



Capacity:	1.22 Bushel (40 to 45 Lb.)
Dimensions (OD):	L 19" x W 19" x H 10.5"
Material:	Polyethylene, UV Stabilized, FDA approved
Weight:	5.1 Lb.
Storage:	(Quarter turn) Stack to Nest

Item #	Description	1-24	25+
11768	Blue Box, No Drain Holes	\$15.00	\$14.70
3804	Orange Box, W/Drain Holes	\$15.00	\$14.70

Harvest Containers



	PC-08	PC-07	PC-09
Color:	Gray	Yellow	Yellow
Capacity:	7/8 Bu.	7/8 Bu.	1-1/8 Bu.
Length:	24"	23.6"	23.8"
Width:	16.13"	15.7"	17.8"
Height:	7.25"	7"	7.6"
Material:	Polyethylene	High-Density Polyethylene	
Drainage:	Ventilated bottom and 2 sides		
Storage:	(Half turn) Stack to Nest		
Weight:	3.1 Lb.	3.25 Lb.	4 Lb.

Item #	Description	1-24	25-Skid
10632	7/8 Bu. Gray Container	\$12.50	\$12.10
4667	7/8 Bu. Yellow Container	\$16.25	\$15.80
10411	1-1/8 Bu. Yellow Container	\$17.25	\$16.90

Wooden Baskets



Item #	Description	1-49	50+
10268	1 Peck	\$3.20	\$2.95
2815	1/2 Bushel	\$3.45	\$3.25



RUBBER BANDS, ADVANTAGE



Item #	Size	Color	Pcs/Lb.	Typical Use
13199	4½" x 3/16"	Red	280	Cauliflower
4448	4½" x 3/16"	Green	280	Cauliflower
BAN1Y	4½" x 3/16"	Yellow	280	Cauliflower
BAN1B	4½" x 3/16"	Blue	280	Cauliflower
10637	3" x ¼"	Red	370	Beets, etc.
4449	2½" x ¼"	Red	425	Asparagus, Broccoli, etc.
4450	3½" x 1/8"	Red	475	All purpose
12545	3" x 1/8"	Red	700	Indian Corn, etc.
10499	2" x 1/8"	Red	1,300	Indian Fingers, etc.
12638	2½ x 1/16"	Red	1,700	Radish, Onions
10634	2 x 1/16"	Red	2,200	Radish, etc.

All bands are sold in 1 Lb. Bags	Price (1-24)	Case (25+)
See above for item # and size.	\$4.85	\$4.40

WINMORE PACKING TAPE

Holds even in coolers.

Item #	Description	12785	36+
11911	Tan or Clear, 2" x 330'	\$2.60	\$2.15

ROW MARKING FLAGS

4 x 5" white flag on 30" wire.

Item #	Description	Price
321	Marking Flags, 100/Bundle	\$10.50



GREENHOUSE TOMATO TRELLISING HOOKS

For trellising greenhouse tomatoes and cucumbers, etc. Hang on a high wire. Or use S-hooks to hang from pipe.

Twine Hook: Wire hook releases approximately 7" of twine each time they are turned over. The 11976 includes 30 ft. of UV-resistant white twine prewrapped on the hook and 10 ft. loose, so it can free-fall out of the case to speed installation.

Roller Hook: A labor-saving device to lower/lean crops in a smooth, controlled way. Heavy-gauge wire frame supports a spool of twine with 100' of UV-resistant white twine. Easily clips over wire. Concurrently releases twine while sliding down the wire to lower and lean trellised crops.

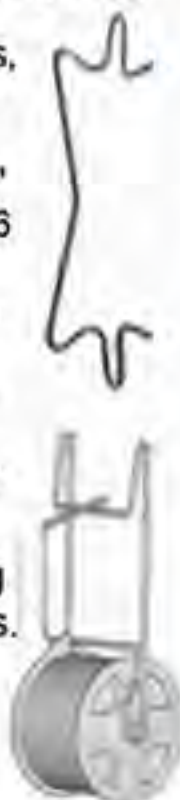

Item #	Description	Each	Pcs/Case
4301	Bare Twine Hook, use HD twine	\$0.16	984 \$0.11ea
11976	Twine Hook loaded W/40' twine	\$0.27	420 \$0.22ea
11890	Roller Hook Frame (wire part)	\$0.24	550 \$0.20ea
11891	Roller Hook Spool W/100' twine	\$0.47	550 \$0.37ea

We also carry more supplies!

- Wooden Berry Boxes
- Clamshell Quarts & Pints
- Red Net Covers
- Carton Staplers

Call for details & pricing.

WAXED CARDBOARD VEGETABLE BOXES



ITEM	SIZE	PRICE
4051	1/2 BUSHEL	\$1.50
4120	1-1/9 BUSHEL	\$2.75
4353	1 BUSHEL - 15 PACK	\$49.00

50LB WAXED CABBAGE BOX



ITEM NO.	PRICE
4134	\$3.75

50LB WAXED CABBAGE BOX. Waxed cardboard cabbage box, holds 50lb of cabbage.

25 LB TOMATO BOX W/O LID, 25/BUNDLE



ITEM NO.	PRICE
5052	\$42.00

Made of high density breathable polyethylene. Lid sold separately.

25 LB TOMATO BOX LID, 25/BUNDLE



ITEM NO.	PRICE
5053	\$12.00

1 BUSHEL BULK APPLE BOXES W/DIVIDERS



ITEM.	DESCRIPTION	PRICE
5085	Inner	\$1.50

Cardboard, 19 5/16" x 12 1/2" x 9 13/16".

ITEM.	DESCRIPTION	PRICE
5086	Outer	\$0.95

PUMPKIN BIN, PLAIN



ITEM NO.	PRICE
4166	\$18.00

PUMPKIN BIN - PLAIN NO FLAP - 46 X 37 X 36.

Seasonal items, please order early!

BERIGARD® MOLDED FIBER BERRY BOXES



Item #	Size	Pcs/Cs	Wt.	1-9	10-49	50+
2524	Quarts	250	18 #	\$27.95	\$26.45	\$25.90
11887	Pints	420	18 #	\$31.50	\$30.00	\$29.00
2525	½ Pints	600	21 #	\$39.00	\$38.00	\$250/Bale

Shippers/Hi-Stackers for Berry Boxes

White cardboard with red print: **Quality Berries** on the quart size and **Farm Fresh Produce** on the pint

	Sold in increments of 25	25-475	500/Bale
12002	8 Count Quart Hi-stacker	\$1.95 Ea.	ASK
10416	12 Count 1 Pint shipper	\$1.70 Ea.	ASK
12283	12 Count ½ Pint shipper	\$1.40 Ea.	ASK

ALUMINUM BERRY CARRIER

Holds 8 - 1 Quart Boxes. It features twin carrying handles that fold to the side of the tray

Item #	Description	Price
10415	Aluminum Berry Carrier	\$31.50



WOOD BERRY BOX



ITEM	SIZE	QUANTITY	PRICE
12315	PT	CASE / 500	\$115.00
4362	QT	CASE / 500	\$127.50

PT/QT VEX CAPS CASE OF 100

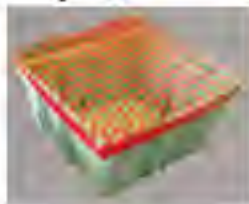

ITEM.	DESCRIPTION	PRICE
4441	100/CASE	\$7.00
4095	10 X 100 CASE	\$67.00

Fits 1 pint/quart pulp or wooden baskets.

10 LB, 1 LAYER CARTON, 25 PER BUNDLE



ITEM NO.	PRICE
10856	\$65.50

8-1QT STRAWBERRY CARTON 8 X 1 QT



ITEM NO.	PRICE
4879	\$2.20

8-1QT STRAWBERRY SHIPPER (HIGH)



ITEM NO.	PRICE
4052	\$2.99

Stacks 1 QT containers of strawberries, holds 8.

PRODUCE BAGS



ITEM	DESCRIPTION	QTY	PRICE
4990	RED PLASTIC NET 15"	1000 PK	\$64.00
3118	CORN BAG, GREEN MESH	1000 PK	\$460.00

APPLE BAGS



ITEM	PRICE
4184	1/2 PECK (500/CS), PLASTIC \$92.56
4185	1 PECK (500/CS), PLASTIC \$150.00
4186	1/2 BUSHEL (250/CS), PLASTIC \$100.00
5102	1/2 PECK (500/CS), PAPER \$87.50
4118	1/2 BUSHEL (250/CS), PAPER \$93.45

SHARPIE FINE PERMANENT MARKER (12 PACK)



ITEM	PRICE
10197	Black Markers \$12.00

The original Sharpie, permanent on most hard-to-mark surfaces. Quick drying ink is waterproof, smearproof, and fade resistant.

CORONA® HAND TOOLS



Item #	Description	Price
HTBP3160	HD Hand Pruner, Classic Cut® Bypass Pruner, resharpenable forged steel blade, cuts up to ¾".	\$19.00
HTBP3214	Economy Hand Pruner, ComfortGEL® Bypass Pruner, non-stick blade, cuts up to ¾".	\$12.00
HTAG4930SS	Snip, Stainless Steel Long Straight Snip, unobtrusive leather strap lock, 1½" pointed blade.	\$10.00
HTSL7180	HD Lopper, Dual Cut™ Bypass Lopper, Fully forged steel construction, 31" handle, cuts up to 2".	\$38.00
HTSL3264	Economy Lopper, ComfortGEL® Bypass Lopper, non-stick blade, 30" handle, cuts up to 1½".	\$21.00
HTAC4510	Universal Tool Scabbard, nylon construction, 5" deep pouch fits hand pruners, snips etc.	\$8.00
HTKN7	Small harvesting knife with 7" HD stainless steel blade and textured non-slip handle, Zenport	\$12.00
HTKN12	Large harvesting knife with 12" HD stainless steel blade and textured non-slip handle, Zenport	\$15.00
HTMA60041	Machete, 18" resharpenable tempered steel blade, riveted non-slip handle.	\$10.00
HTTP3841	Tree Pruner, Dual Compound Action, 15" tempered steel conventional saw blade, extends up to 12' with twist lock adjustment, cuts up to 1".	\$46.00

SHOVELS



ITEM	WEIGHT	PRICE
4595	Round point shovel, 45" wood handle	\$23.99
4592	D-Handle round point shovel, 42.5" overall length, wood handle	\$33.99
3375	D-Handle square point shovel, 42.5" overall length, wood handle	\$28.99
4593	Square shovel, 48" wood handle	\$33.99
3704	Grain Shovel, 12 poly scoop, 48" handle	\$41.99

RAKES & HOES



ITEM	WEIGHT	PRICE
4597	Metal Leaf Rake, 24" head with 24 tines, 54" handle	\$14.99
4598	Poly Leaf Rake, 30" head with 30 tines, 40" fiberglass handle	\$14.99
10764	Bow Head Rake, 16 tine forged head, 60" wood handle	\$36.99
3380	Bow Head Rake, 14 tine, 48" seal coated wood handle	\$15.99
3379	Level Head Rake, 16 tine forged head, 60" wood handle	\$39.99
4724	Aluminum Landscape rake, 30" head, 66" handle	\$57.99
11912	Garden Hoe, 54" fiberglass handle	\$21.99
3377	Onion Hoe, 7" wide forged head, 54" wood handle	\$28.99

BALECORD SISAL TWINE GOLD 9000 BALE OF 2



ITEM NO.	PRICE
4198	\$61.49

Natural fiber sisal twine for small square bales. Treated to resist rodents, rot and mildew. Biodegradable and environmentally friendly. Made in Brazil.

HEAVY DUTY WINMORE TYING TWINE 6500'



ITEM NO.	PRICE
4296	\$22.25

Heavy Duty Winmore Tying Twine, 7 1/2 pound ball, good for use in the greenhouse or the field.

TOMATO TWINE 6300'



ITEM NO.	PRICE
4298	\$7.50

Quality white twine, box has a belt loop.

BALECORD BALER TWINE DOUBLE BALL ORANGE (4500')



ITEM NO.	PRICE
3855	\$34.99

Double ball polypropylene baler twine for small square bales. Recommended for day to day baling in standard forages.

SOUTHERN STATES PREMIUM GREEN LABEL PLUS BALER TWINE



ITEM NO.	PRICE
3856	\$58.99

10M GREEN. Statesman Gold Label Premium Twines are manufactured from carefully selected, certified, long, white brushed fibers, expertly spun to insure uniformity and extra strength for smooth running, economical operation. Gold Label has superior tensile strength and is knotless, resistant to rot, insects and rodents. Maximum tonnage per acre is possible with this twine.



AXIOM MEASURING PITCHER

ITEM NO.	SIZE	PRICE
381	128 oz.	\$14.99
382	64 oz.	\$8.99
1860	32 oz.	\$6.99
1859	16 oz.	\$6.99
383	8 oz.	\$6.49

Durable construction made from food grade polypropylene with steep resistance to a variety of chemicals. Measurement in US fl. Oz and metric debossed in black to be easily read. Excellent pouring control and provide entire control from a fine trickle to a fast pour.



Treated TOMATO STAKES

SHARPENED HONDURAS PINE STAKES

Pressure treated rot resistant wood. Sold in pks of 25pcs.

3483	1" x 1" x 48"	\$ 59.00 /100
	Full Skid of 1400	57.00 /100
4939	1" x 1" x 54"	73.00 /100
	Full Skid of 1400	71.00 /100
3574	1" x 1" x 60"	82.00 /100
	Full Skid of 1400	139.00 /100
3575	1-1/4" x 1-1/4" x 72"	136.00 /100
	Full Skid of 1050	131.00 /100
TS-248	3/4" x 1" x 48"	45.00 /100
	Full Skid of 1575	43.00 /100

Untreated White Oak TOMATO STAKES

For organic growing. Uniform 1" x 1" square, sharpened.

3948	48"	75.00 /100	Skid of 1050	65.00/100
4661	60"	75.00 /100	Skid of 1050	75.00/100
4898	72"	91.00 /100	Skid of 1050	92.00/100

Untreated Eucalyptus TOMATO STAKES

Brazilian Eucalyptus is naturally resistant to rot and mold. Sharpened. 12474 1-1/4"x1-1/4" x 72" 125.00 /100

Full Skid of 840 \$924.00 118.00/100

HD TOMATO TRELLIS



Supports Plants and Row Cover, 3/8" rod frame is 8" wide, 37" high plus 13" long legs and 24" wide at the base. Space 4-5' apart on the row and hook twine into hooks to make trellis. Spaces twine so tomatoes are not jammed between the twine as with regular trellising. Heavy Dupont cover with ropes hemmed into edges simply hooks to bottom hooks on frame. Always install all twine before installing cover.



11750	Trellis	\$ 7.95 each
50+	Trellis	\$ 6.90 each
200+	Trellis	\$ 6.85 each

12247 Cover 82"X 500' \$272.50



TOMATO CAGES

HEAVY-DUTY 36 inch high
Top Ring Dia. 16"
Bottom Ring Dia 13"

11792

1-99	\$ 5.00 each
100-499	5.10 each
500 & up	4.75 each

Heavy Duty Square Tomato Cage



13-1/2" Square, All galvanized steel, spot welded. Top Corners are rounded, excellent for use with row cover. Folds for ease of handling and storage. Double corner posts for greater strength & stability. Designed to go into soil 10", (up to first cross piece).

1-99 100-199 200+

TC13 Standard 40" High	9.05ea	8.55ea	8.20ea
11800 Tall 56" High	11.85ea	11.25ea	11.00ea

BLACK VINE CLIPS

These are used when growing tall plants, or vine crops to clip the plant to a string or trellis support wire. They are primarily used by tomato, cucumber and pepper growers. UV Stabilized.

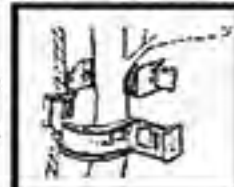

4821	Box/1000	\$ 15.25
11892	Case/10,000	\$ 92.50

Greenhouse Tomato Trellis

Tired of trying to extend tomato stakes when your plants out grow them? This is a labor-saving device to trellis greenhouse tomatoes. Designed with determinate tomato plants in mind, especially grafted plants or varieties that grow to tall for tomato stakes. Will only work with greenhouses that have cross-ties on each arch.

To install: Run a purlin pipe the length of the row (over top of the cross-ties) then hang these trellises between every other plant. Brace first and last trellis (see picture for brace idea). Then install tomato twine as needed to support the growing plants. Installing twine is easy, even once the plants are 5 plus feet tall. Cut as needed to fit structure heights. Taller structures you may need to use short stakes for the first row or two of twine. Hook fits 1-3/8" OD and smaller pipe.



Item #	Description	Price	50+	200+
GTT098	98" Long, 12 hooks	\$7.40	\$7.00	\$6.65
GTT108	108" Long, 12 hooks	\$7.55	\$7.15	\$6.80

PLASTIC MULCH WORKS FOR YOU *It controls weeds and increases harvest.*



Embossed mulch is our best quality plastic. Embossed mulch does not expand as much when the sun shines on it and therefore it will not flop as much in the wind on a sunny day. It has superior strength for easiest removal.

Call for pricing on 48+ Rolls

EMBOSSSED Black & Clear

This is a reinforced and highly durable embossed mulch which blocks weeds and prevents soil from coming into direct contact with fruit and fresh vegetables.

Reinforced and tough to resist tearing.

Can be laid at higher speeds.

UV Stabilized, designed to last the duration of your growing season.

Stretches very well and hugs tight to the bed.

Works with practically all crop varieties.

SUPER STRENGTH EMBOSSSED MULCH

1 mil is equal in strength to most 1.1 mil formula's.

.8 mil is recommended for covering sweet corn.

1.25 & 1.5 mil is for multiple seasons for strawberries, etc.

All Sizes Can Be Shipped UPS			Mil	1-19 Rolls	20+ Rolls
3589	3' x 3000'	Black	1	\$65.00	\$63.00
4379	4' x 2400'	Black	1	\$68.00	\$66.00
4533	4' x 2400'	Black	1	\$104.00	\$100.00
2807	4' x 4000'	Black	1	\$111.00	\$108.00
11863	4' x 4000'	Black	1.25	\$139.00	\$135.00
4580	5' x 2400'	Black	1	\$86.00	\$84.00
4314	5' x 2400'	Black	1.2	\$108.00	\$105.00
10778	6' x 2400'	Black	1	\$105.00	\$102.00
11864	4' x 4000'	Clear	1	\$114.00	\$110.00
2920	5' x 4000'	Clear	1	\$139.00	\$134.00
	6' x 2000'	Clear	1	\$88.00	\$86.00

Be sure drip tape is buried in soil, especially under CLEAR Plastic as water droplets can magnify the sun & burn holes in the drip tape.

EMBOSSSED GREEN

The GREEN PLASTIC MULCH that gives the heat of clear plastic, but reduces weed growths, no fumigation needed. It combines The Advantages of Clear and Black. Ideal for early season crops.

			Wt. Lbs.	
GE-34	3' x 4000'	1 Mil	60	\$110.00
GE-44	4' x 4000'	1.0 Mil	80	\$147.00
4673	4' x 2400'	1¼ Mil	60	\$110.00
GE-54	5' x 4000'	1.0 Mil	100	\$189.00

A freight charge will apply to all prices listed above.

MULCH COVERINGS



PREFERRED VENDOR

Micro-EMBOSSSED BLACK



Superior stretchability and hugs tight to the bed. The least expansion in the sun. Recommended for raised beds in sandy soils or windy areas.

			Wt lbs.	1-15 Rolls	16+ Rolls
4941	4' x 4000'	1 Mil	80	111.00	108.00
2829	5' x 4000'	1 Mil	100	138.50	135.00
4325	4' x 4000'	1.25 Mil	100	138.50	135.00

Embossed WHITE ON BLACK

An ultra reflective top white layer actually decreases the soil temperature to promote growth for heat sensitive crops or warm climates, and provides additional light reflection to the underside of foliage. The black (bottom) layer stops weed growth.

			Wt lbs.	1-15 Rolls	16+ Rolls
12343	3' x 4000'	1 Mil	60	\$112.00	\$109.00
3592	4' x 2400'	1.25 Mil	60	\$112.00	\$109.00
2808	4' x 4000'	1 Mil	80	\$147.00	\$144.00
3800	5' x 4000'	1 Mil	100	\$184.00	\$180.00



Made of Mater-Bi, a starch based material. Novamont produces Mater-Bi with renewable resources such as starches from different non-GMO crops: corn & other cereals, potatoes, & vegetable oils. Mater-Bi complies with international biodegradation and environmental standards such as EN 13432 by Vinçotte and ASTM D6400 by BPI, which guarantee complete biodegradation in soil without any toxic residues. Not OMRI listed.

Degradation rate depends on film thickness, climate, and soil type. Starts breaking approx 4 -5 month on .6mil and 5-6 month on .8mil. Mfg. does not guarantee the film's life span due to different conditions such as non-compliance with laying & usage conditions, climatic conditions, etc.

Lay relatively loose and after a few hours or by the next day, the mulch tightens and clings to the soil bed.

BLACK Bio360

			1-15 Rolls	16+ Rolls
BTB6343'	x 4000'	.6 mil Black	\$161.00	\$157.00
10458	4' x 2400'	.6 mil Black	\$126.00	\$123.00
4530	4' x 4000'	.6 mil Black	\$202.00	\$197.00
4914	5' x 4000'	.6 mil Black	\$264.00	\$257.00
11983	4' x 4000'	.8 mil Black	\$266.00	\$259.00

Metalized Aluminum on Black

Reflective metalized color on the top deters insects. The black (bottom) layer stops weed growth.

Heat trap is a 8" wide black strip in center which keeps heat reduction to minimum.

All Sizes Can Be Shipped UPS

			Mil	1-19 Rolls	16+ Rolls
11834	4' x 2400'	With Heat Trap	1.25	\$135.00	\$131.50
4873	4' x 4000'	NO Heat Trap	1	\$173.00	\$166.50
SB 54	5' x 4000'	NO Heat Trap	1	\$216.00	\$210.50
2834	6' x 2400'	NO Heat Trap	1.25	\$185.00	\$180.00

Micro-Embossed RED

Has shown increased yields on Tomatoes. Also warms the soil faster than black.

SRM4241	4' x 2400'	1.25 Mil	Wt. 60 lb	\$132.50
---------	------------	----------	-----------	----------

ECO-ONE Oxo-Degradable

Environmentally sound degradation. Laboratory studies indicate that this degradable plastic breaks down into CO₂, H₂O, and biomass without toxic residues. Degrades fully both above and below soil. Avoid excessive tension when laying and plant immediately after laying. Liability from the manufacture is limited to product defects to the extent of the value of the film. Breakdown period can vary depending on the conditions. This film will break down faster in direct sunlight. We primarily recommend this film for crops where the foliage is casting shade over the film, such as vine crops.

STANDARD LIFESPAN, Starts degrading in 3 - 4 month.

				1-9 Rolls	10+ Rolls
3808	4' x 8000'	.5 Mil	Black	\$254.00	\$247.00
E1B558	5' x 8000'	.5 Mil	Black	\$325.00	\$317.00

EXTENDED LIFESPAN, Starts degrading in 5 - 6 month

				1-9 Roll	10+ Rolls
E1B648L	4' x 8000'	.6 Mil	Black	\$325.00	\$317.00

BLACK/WHITE SILAGE SHEET



6 MIL Silage sheets made of co-extruded low density polyethylene, UV treated. Used to cover silage put into the ground, black on one side, white on the other.

ITEM	SIZE	PRICE
4369	32 x 100	\$185.00
4370	32 x 150	\$265.00
4371	40 x 100	\$229.00
4372	40 x 150	\$395.00
4373	50 x 100	\$239.00
4639	50 X 150	\$425.00
4248	50 X 150 (5 MIL)	\$350.00



MULCH COVERINGS



PREFERRED VENDOR

Frost Protection

These non-woven, polypropylene fabrics are soft, easy to handle, UV stable, and porous to air, light and water. A management tool to prevent losses from adverse weather and to provide an earlier harvest or extended harvest in the fall. Clear or green plastic mulch is recommended underneath floating row cover for early spring planting, since they put more heat into the soil through the daytime which keeps the temperature from dropping as rapidly after dark.

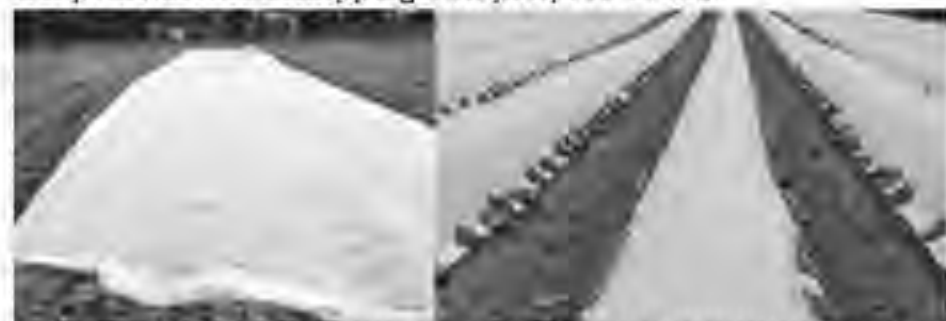

DeWitt Floating Row Cover, 0.55 Oz/Sq Yd

Our lightest weight cover but 10% heavier than most competitors. Seams are sewn for strength and durability.
• 85% Light Transmission • Protects to 30°-31°F

Item #	Size	Weight	1-3 Rolls	4+
D050705	7' x 500'	24 lb.	\$52.00	\$50.50
D05071	7' x 1,000'	37 lb.	\$99.00	\$96.00
D051005	10' x 500'	31 lb.	\$72.00	\$70.00
D05141	14' x 1,000'	64 lb.	\$196.00	\$190.00
D05201	20' x 1,000'	87 lb.	\$304.00	\$295.00
D05301	30' x 1,000'	131 lb.	\$460.00	\$446.00
D05401	40' x 1,000'	188 lb.	\$618.00	\$599.00
D055005	50' x 500'	108 lb.	\$388.00	\$376.00

Shipping Note: 14' thru 50' width ship via truck.

Pre-arched Wire Hoops

Heavy duty wire hoops made from 3/16" high-tensile steel wire. Precut and pre-arched. Call for price on full skid of 30 bundles.



Item #	Description	1-9	10+
4660	64" Wire Hoops, 100/bundle	\$44.00	\$42.50
3469	76" Wire Hoops, 100/bundle	\$50.00	\$48.50

Spring Steel Hoops

Standard spring steel hoop for use with mechanical tunnel layer. Shipping weight: 21 lbs/bundle. Full crate = 5000 pieces.

Item #	Description	1-9	10-49	50+
WH 640	64" Spring Steel, 100/bdl	\$30.00	\$27.00	\$24.00

Perforated Row Cover

This film keeps a very hot environment in early spring, acting as a mini greenhouse. 3/8" Dia. holes provide a method of venting. 1.1 mil smooth plastic. Note: White is cooler than clear.

Item #	Description	1-9	10+
4534	6' x 2,000' Clear Perforated	\$98.00	\$95.50
CPC6W	6' x 2,000' White Perforated	\$101.00	\$98.50

DeWitt Floating Row Cover, 1 Oz/Sq Yd

This DeluxePlus row cover is close to twice as heavy as the 0.55 oz. for almost twice the frost protection. Good for strawberries and to extend fall harvests. Can usually be used for two seasons. Seams are sewn for strength and durability.
• 70% Light Transmission • Protects to 28°-30°F

Item #	Size	Weight	1-3 Rolls	4+
11727	7' x 500'	26 lb.	\$80.00	\$77.50
12014	7' x 1,000'	52 lb.	\$149.00	\$144.50
12753	10' x 500'	37 lb.	\$106.00	\$103.00
12435	14' x 500'	53 lb.	\$198.00	\$192.00
12902	14' x 1,000'	102 lb.	\$380.00	\$368.00
11889	20' x 1,000'	143 lb.	\$485.00	\$470.00
D1027	27' x 800'	155 lb.	\$510.00	\$495.00
12015	39' x 800'	222 lb.	\$755.00	\$732.00
11903	50' x 500'	177 lb.	\$590.00	\$572.00

Shipping Note: 14' x 1,000' thru 50' x 500' width ship via truck.

Typar® T-518 Row Cover, 1.25 Oz/Sq Yd

A strong, heavy (1.25 oz./sq. yd.) spunbonded polypropylene frost protection fabric. Seams are sewn for strength and durability. Light transmission: 70%. Frost protection: 5-6°+. Superior strength, lasts for 4+ years. An excellent choice for most crops and seasons.

Can also be custom ordered any length and width (in 5' increments) required to cover a specific area. All sizes drop ship from Roanoke Rapids, NC. Allow 2 weeks for delivery.

Length	15' wide	30' wide	45' wide	60' wide
50'	\$45.00*	\$91.00*	\$136.00*	\$182.00
100'	\$85.00*	\$175.00*	\$266.00	\$356.00
150'	\$125.00*	\$257.00*	\$392.00	\$524.00
200'	\$161.00*	\$335.00	\$512.00	\$685.00
250'	\$198.00*	\$412.00	\$629.00	\$844.00
300'	\$234.00*	\$487.00	\$750.00	\$1000.00
350'	\$270.00	\$567.00	\$865.00	\$1150.00
400'	\$306.00	\$642.00	\$980.00	\$1300.00
450'	\$341.00	\$714.00	\$1089.00	N/A
500'	\$375.00	\$785.00	\$1198.00	N/A

* Indicates sizes that can ship UPS Ground. Larger sizes and orders are shipped truck freight.

Shipping cost is additional. (Discounted shipping from factory in Roanoke Rapids, NC.)

5% Discount on orders of \$500 or more. Applies to all sizes over \$500, or multiple pcs. Sizes can be mixed/matched.

Anchor Bags

These anchor bags can be filled with sand, dirt or gravel and used to secure row cover. For plastic bags, use cable ties to close (see page 42). Woven bags are more puncture resistant.



Item #	Description	Price
4579	12" x 24" 6 mil Black Plastic Anchor Bags, UV treated	250/Case \$82.50 = 0.33ea
4672	14" x 26" Woven Black Polypropylene Anchor Bags, UV treated, with tie string	100/Pack \$34.00 1000/Case \$320.00

We can supply your Typar® needs, but freight will be additional.

MULCH COVERINGS

MULCH COVERINGS



PREFERRED VENDOR

ProtekNet™ Insect Netting

Pest and insect control netting for fruits and vegetables. Also protects crops against weather damage. No thermal effect (unlike crop cover).



25 gram 0.35mm x 0.35mm white synthetic fiber.

89% light transmission. Very pliable, great for row crops. Life expectancy: 1-3 years. **Protects against:** Aphids, Armyworm, Brown Stink Bug, Cabbage Root Fly, Carrot Rust Fly, Chrysomelid, Corn Borer, Mite (Not 100%), Flea Beetles, Leafhopper, Leek Moth, Nymph, Onion Maggot, Sawfly, Seedcorn, Spotted Wing Drosophila, Squash Bug, Swede Midge (Not 100%), Tarnished Plant Bug, Thrips (Not 100%).

Item #	Description	Price	Ship Via	Weight
3591	83" x 328' 25 Gram	\$225.00	UPS	14 Lbs.
12013	83" x 820' 25 Gram	\$515.00	UPS	30 Lbs.
PN253250	10' x 820' 25 Gram	\$720.00	UPS	43 Lbs.
12509	14' x 328' 25 Gram	\$430.00	UPS	26 Lbs.
12599	14' x 820' 25 Gram	\$1025.00	UPS	60 Lbs.

60 gram 1.9mm x 0.95mm. Clear polyethylene.

93% light transmission. Life span 5 yrs. Can be used under greenhouse curtains. **Protects against:** Armyworm, Brown Marmorated Stink Bug, Cabbage Root Fly, Chrysomelid, Corn Borer, Onion Maggot, Sawfly, Seedcorn, Spotted Wing Drosophila (Not 100%), Squash Bug, Tarnished Plant Bug.

Item #	Description	Price	Ship Via	Weight
4098	83" x 328' 60 Gram	\$292.00	UPS	32
10639	14' x 328' 60 Gram	\$575.00	UPS	64

47gram is now available: Life expectancy 8-10 years and it will control the Flea Beetles & Swede Midge. However not Thrips or Aphids like the 25gram will, but more durable. **Call for pricing.**

Bird Control Netting

This bird control netting is ideal for crop protection against birds on berries & fruit trees. Flexible high density with 3/4" diamond pattern and 5 year life span.



Green Polyethylene			White Polyethylene		
Item #	Size	Price	Item #	Size	Price
3802	16' x 98'	\$105.00	BNW21	21' x 328'	\$315.00
3835	32' x 49'	\$105.00	BNW33	33' x 328'	\$475.00
BN30100	32' x 98'	\$202.00	BNW49	49' x 328'	\$698.00

Black Woven Ground Cover

See additional sizes page 51

This UV stabilized, woven cloth is extremely strong and far superior to sheet plastic. This woven polypropylene fabric that is permeable to air and water, yet blocks weeds effectively. 3-.2 - 3.3 oz./sq. yd. with stripes every foot.

Item #	Size	1 to 5	6+	Ship Via	Weight
3799	3' x 300'	\$38.50	\$36.50	Ground	25 Lbs.
3638	4' x 300'	\$50.50	\$48.00	Ground	33 Lbs.
2764	6' x 300'	\$75.50	\$72.00	Ground	50 Lbs.

For wider sizes or white contact: Nolt's Greenhouse Supplies

UltraWeb Black Woven Ground Cover

Popular as a weed barrier between rows of plastic mulch. Same as the black ground cover above except lighter weight at 2.2 oz./sq. yd. with stripes every foot.

Item #	Size	1 to 3	4+	Ship Via	Weight
11973	3' x 1200'	\$115.00	\$103.50	Ground	66 Lbs.
12073	4' x 900'	\$115.00	\$103.50	Ground	66 Lbs.

Steel Sod Staples

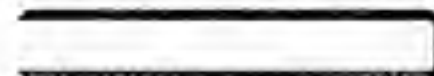

Item #	Description	1 to 4	5+
SS88	HD Staples, 8" x 1", 8 gauge, 500/box	\$36.00	\$34.00
SS611	Staples, 6" x 1", 11 gauge, 1,000/box	\$32.00	\$30.00

Bird Scare Balloons

Elevate at least two feet above your crop and rotate colors for best results.



Item #	Description	Price	10+
4172	Bird Scare Balloon, White	\$8.05	\$7.25
4174	Bird Scare Balloon, Yellow	\$8.05	\$7.25
4173	Bird Scare Balloon, Black	\$8.05	\$7.25
12000	3 Pack, 1 each of White, Yellow, & Black	\$21.00	—

Bird Scare Tape

Deters birds with flashy appearance and noisy crackle.



Item #	Description	Price	5+
5012	Bird Scare Tape, 1 1/4" x 290' Roll	\$7.50	\$6.95

WE ARE A PROUD DEALER OF NOLT'S PRODUCE AND GREENHOUSE SUPPLY.



Have a farmstand or store?
Value-added products from our Cape Cod Provisions
are the perfect companion to boost your sales!

Cape Cod PROVISIONS

One Company, Four Sweet Brands

HARVEST
SWEETS 

Cape Cod
Cranberry Candy™

New England
@ Heart. 

Sweet Cravings®



Chocolate Covered Fruits & Nuts · Fruit & Dessert Truffles
Cape Cod Cranberry Bog Frogs® · Cape Cod Cranberry Candy™

(508) 564-5840 | www.CapeCodProvisions.com

WATER DRIVEN & ELECTRIC PUMPS

FOR FERTILIZER, ACID, SANITIZERS & MOST CHEMICALS

MixRite



 FLEXFLOW

DEMA®

AGRICULTURE SOLUTIONS



Protecting Our Farmers and Farm Families

There are a number of respiratory hazards in the agricultural industry which include organic dusts, molds, bacteria, gases from fermentation of silage and manure, inorganic dusts, pesticides and other agricultural chemicals.



The Sundstrom Solution

Our Pro Pack offers an excellent fit, a very high protection level and easy breathing comfort. This Ready-To-Go respirator kit is available as a full face or half mask kit.



The Pro Pack includes an SR 100 half mask or SR 200 full face mask, SR 232 OV/SD/CL/HC/HF chemical cartridge, SR 510 particulate filter, SR 221 prefilter (5), prefilter holder, SR 5226 cleaning wipe and SR 368 ID tag in a convenient storage box.

* Additional APR and PAPR Kits are available to meet your needs.

Phone: 1-877-SUNDSTROM
Email: info@srsafety.com
Rhode Island, USA

Sundström



Competitively Supplying All of Your Growing Needs

PO Box 278 • West Wareham, MA 02576
(508) 273-7358
www.ProgressiveGrower.com

HOW TO SHOP PROGRESSIVE GROWER

- **Visit one of our locations**

Progressive Grower – Wareham
81 Charlotte Furnace Road
West Wareham, MA 02576
(508) 273-7358

Progressive Grower – Riverhead
1129 Cross River Drive
Riverhead, NY 11901
(631) 591-3540

Progressive Grower – Islandia
100 Patco Ct
Islandia, NY 11749
(631) 778-6577

Progressive Grower – Albany
12 Walker Way Unit 1B
Albany, NY 12205
(518) 456-0932

- **Email your order**

Info@ProgressiveGrower.com

- **Fax your order**

(774) 678-0373