



NEW ENGLAND • NEW YORK

2023 Source Book

Commercial Growers Guide

Agricultural Chemicals

Fertilizer

Organic Products

Greenhouse Supplies

Farm Supplies

Equipment

Irrigation



GO LONG.

CHOOSE SEASON-LONG FOLIAR DISEASE PROTECTION THAT STARTS AT PLANT.

Xyway® brand fungicides from FMC are the first and only at-plant corn fungicides to provide season-long, inside-out foliar disease protection from planting to harvest. A single application provides comparable performance and corn yield protection to that of VT/R1 foliar fungicides against diseases like gray leaf spot, Northern corn leaf blight, common rust and many more.

The most mobile fungicide active ingredient on the market, flutriafol moves from the soil through your corn plants as they grow, for inside-out protection from roots to tassel. With Xyway brand fungicides, disease threats become the least of your worries when you need it most: all season long.

VISIT YOUR FMC RETAILER OR XYWAY.AG.FMC.COM TO LEARN MORE.

Always read and follow all label directions, precautions and restrictions for use. Some products may not be registered for sale or use in all states. Xyway 3D fungicide and Xyway LFR fungicide may not be registered for sale or use in all states. Contact your local FMC retailer or representative for details and availability in your state. FMC, the FMC logo, LFR and Xyway are trademarks of FMC Corporation or an affiliate. ©2022 FMC Corporation. All rights reserved. 22-FMC-2376 09/22



INDEX

A	
Adjuvants - conventional	6
Anchor Bags	100
Apple Bags and Boxes	94
B	
BCS	28, 29
Berry Boxes	94
Bird Netting	101
Bird Repellent	101
C	
Camlocks	75
Coconut Coir	71
Compost	72
Corn Bags	94
Cultivator	35
D	
Decorative Planters	63, 64
Drip Tape	75, 80
Drip Tape Fittings	75, 81
F	
Fencing	89, 90
Fence Chargers	89
Fertilizer - granular , conventional	13
Fertilizer - granular , organic	20, 22
Fertilizer Ingredients - conventional	13
Fertilizer Ingredients - organic	23
Fertilizer - liquid, organic	21, 22
Fertilizer - soluble, conventional	15
Filters	74,84,86,87
Flower Pouches	67
Foggers	37
Fungicides - conventional	6, 7
Fungicides - organic.....	25
G	
Greenhouse Chemicals	68
Greenhouse Drip Irrigation	38, 39, 40, 73
Greenhouse Doors	47
Greenhouse Fans & Shutters.....	42, 48
Greenhouse Frames	51, 52, 53
Greenhouse Heaters	49
Greenhouse Plastics & Coverings	42
Greenhouse Structure Supplies	42-50
Greenhouse Thermostats & Alarms	49, 50
Ground Cover	74,102
H	
Hand Tools	95
Hanging Baskets	61, 62, 65
Harvest Containers	91, 92
Heat Mats	67
Herbicides - conventional	7
Horticubes	54
Hoops	100
Hose	66
Humidity Domes	67
Hydrants	84

I	
Injectors	73, 76, 77, 86
Insect Monitoring	67
Insect Netting	101
Insecticides - conventional	8
Insecticides - organic	26
Insert Hose Fittings	73, 82
Inserts	55, 64
J	
Jiffy	62
L	
Layflat	79
M	
Masks	11
Measuring Pitchers	11
Micro/Macro Nutrients, organic	24
Miticides - conventional	8
Mulch Layer	30, 31, 34, 35
Mum Pans	59
N	
Nursery Containers	60
O	
Orchard Tubing	75, 79
Oval Hose	79
P	
Planter Bags	59
Plant Growth Regulators - conventional	8
Plant labels	59
Plastic Mulch	98, 99
Plug Sheets and Trays	56
Poly Pipe	79
Polycarbonate	43
Pots	57,58
Pressure Regulators	84
Produce Boxes and Bags	93
PVC Pipe	79
R	
Rodenticides	10
Round Pots and Trays	58
Row Cover	74, 100
Rubber Bands	93
S	
Seeds	17
Seeders	32, 35
Seedling Trays	56
Shade Cloth	41
Silage Sheets	99
Soil Amendments - conventional	15
Soil Amendments - organic	23,24
Soil/Growing Media	70, 71, 72
Sprayers	36
Spreaders	33, 35
Staples	102
Square Pots and Trays.....	57
SCH40 Fittings	83

T	
Timers/Controllers/ Alarms	49, 50
Tomato Clips	97
Tomato Trellis	97
Tomato Stakes	96
Tools	95
Tractors & Attachments	28, 29, 33, 34
Trays	55, 57, 58, 64
Twine	96
V - Z	
Valves	84
Waterers	66, 78
Wirelock	43
Zig Zag Wire	43

QUICK FIND

AGRICULTURAL CHEMICALS 6 - 10

SAFETY 11

FERTILIZER 13 - 16

SEEDS 17

ORGANIC PRODUCTS 18-26

EQUIPMENT 28-36

GREENHOUSE 37-68

SOIL 70-72

IRRIGATION 73-88

FARM SUPPLIES 89-97

CROP COVER 98-102



Shop online and pay bill at

www.ProgressiveGrower.com

Shop 24/7 • Multi-device-friendly • Easy to use

Ask us about advertising on our website and 2024 Source Book!

Thank You for Shopping Progressive Grower!

We encourage you to submit your orders two weeks before pickup or ship date to allow us time to process and pack your order. We reserve the right to pro-rate any items in short supply. Please pickup orders no later than the month after ordering. Orders left after 30 days will be subject to available supply and price.

Upon receiving your order please inspect it immediately and report any error, shortage or damage within 3 days. Progressive Grower is not responsible for shortages reported more than 3 days after receipt.

Returns: Saleable products may be returned with permission and may be subject to handling charges based on the condition and time of return for seasonal products. Expired products, fertilizers, seed, special order, and non-stock items are not returnable.

Credit Invoices: In the case of overpayments, cancellations, shortages, returns, defective products, etc. credit invoices will be issued. Credit invoices not used will be mailed annually, but after 15 months will be voided.

All prices are FOB West Wareham, MA or Riverhead, NY (except items with indicated FOB point) and are subject to change without notice.

Contact us for pricing discounts on large quantity orders.

2024 PRE-ORDER GUIDE

Please keep in mind some items should be ordered early to insure you get them in a timely manner. Also some of these items are in short supply or can only be brought in once or twice a year. Please review the following list and consider placing your order today.

- Mulch Plastic
- Drip Tape
- Silage Sheets
- Rain Flo Equipment
- Green House Items
- Custom Fertilizer Blends
- Onions, Asparagus, Seed Potatoes, Sweet Potato Slips

TERMS

Credit Card or Check in Advance.



SHIPPING OPTIONS

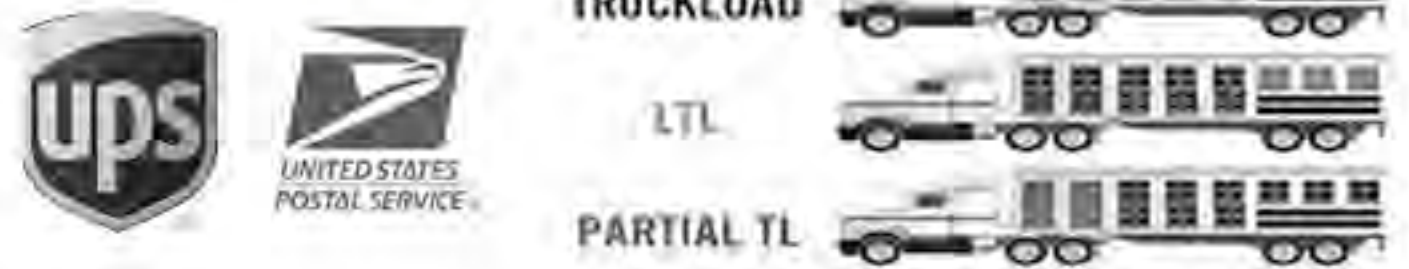

We also offer UPS Next Day Air and other expedited shipping options. When Shipping LTL motor freight we compare prices among numerous carriers to find the best rates.

Progressive Grower trucks deliver in New England and New York. We will ship your order in the most economical way possible.

Prices in this catalog are subject to change without notice. We are not responsible for typos.

A Letter to Our Customers

We really appreciate your business and hope that our service meets your expectations. Since 2020 we have seen a myriad of challenges in our industry. For 2023 we are expecting traditional fertilizer pricing to continue to rise and the pesticides for crop production, as well as most of your other needed supplies, to be on the increase. We encourage you to use this catalog as a handbook for placing your orders with the understanding that stock availability is ever changing, and the prices may change with no notice. As always, we will need as much notice as possible to prepare orders and schedule deliveries.

If you have any questions about inventory or prices, please call us at **844.357.6617** or email us at info@progressivegrower.com.

Sincerely,

All of us at Progressive Grower

PROTECTING YOUR
PASSION

HAS BEEN OUR
PRIVILEGE

FOR
OVER 60 YEARS

 **SANDEA**[®]
HERBICIDE

Badge[®] **SC**
Fungicide/Bactericide

 **TORINO**[®]
FUNGICIDE

Imidan[®] **70-W**
Agricultural Insecticide

 **QUINTEC**[®]
FUNGICIDE

 **METTLE**[®]
125 ME
FUNGICIDE

FOR MORE INFORMATION
ALEX DECKEY
845-745-9246
ADECKEY@GOWANCO.COM

Imidan[®] and Sandea[®] are registered trademarks of Gowan Company, L.L.C.
Badge[®] is a registered trademark of Gowan Company, L.L.C. Torino[®] is a registered
trademark of Nippon Soda Co., Ltd. Quintec[®] is a registered trademark of Nissan
Chemical Corporation. Always read and follow label directions.

Gowan[®]
USA

AGRICULTURAL CHEMICALS



AGRICULTURAL CHEMICALS

We will not ship product to a state where the product is not registered. Please inquire for pricing.
More products available. Please call if seeking something not listed here.

ADJUVANTS

ITEM	DESCRIPTION	SIZE (S)
3989	AMS MAX	2.5 GAL
12205	FOAM KILL	1 QT.
465	FS AQUASUPREME 2.0 NIS-ACTIVATOR	2.5 GAL
2605	FS BARRIER-DRIFT RETARDANT	1 QT.
2357	FS COC SUPREME CROP OIL	2.5 GAL
467	FS CROPSTIK	1 GAL
3606	FS MSO ULTRA	2.5 GAL
3912	NU FILM P	1 GAL
2974	PROGRESSIVE CROP OIL	2.5 GAL
2604	REGULAID	2.5 GAL
3122	SPEED	1 GAL
1539	SUPER SIGNAL BLUE DYE	1 QT
1578	SUPER SIGNAL BLUE DYE	2.5 GAL
4980	TRANSPORT ULTRA	2.5 GAL
10844	X-MARK FOAM	1 GAL

FUNGICIDES / BACTERIACIDES (CONTINUED)

ITEM	DESCRIPTION	SIZE (S)
12284	FLINT® EXTRA	32 OZ
2635	FONTELIS	80 OZ
2356	GAVEL 75 DF	30 LB
5153	INDAR 2F	1 GAL
2458	INSPIRE SUPER	1 GAL
2612	KOCIDE 3000	4 LB
435	KOCIDE 3000	10 LB
3572	LIME SULFUR	5 GAL
12895	LIME SULFUR	55 GAL
10791	LUNA EXPERIENCE	64 OZ
21-0450	LUNA SENSATION (not available on Long Island)	64 OZ
4843	MANKOCIDE	30 LB
3529	MANZATE MAX	2.5 GAL
2380	MANZATE PROSTICK	6 LB
12070	METTLE 125ME	30 OZ
4929	METTLE 125ME	1 GAL
3029	MICROTHIOL DISPERSS SULFUR	30 LB
4119	MILSTOP, OMRI	5 LB
2485	MYCOSHIELD	2 LB
3586	NUTROL 0-50-32	50 LBS
13123	ORONDIS OPTI	2.5 GAL
4112	OSO 5% SC	1 QT
497	OXIDATE 2.0	2.5 GAL
12974	OXIDATE 2.0	5 GAL
14814	OXIDATE 2.0	30 GAL
10939	OXIPHOS	1.5 GAL
4789	PENNCOZEB	31 LB
3604	PH-D	2 LB
4087	PHITICIDE /FUNGI-PHITE	2.5 GAL
2549	PRESIDIO	1 QT
2404	PREVICUR FLEX	2.5 GAL
2333	PRISTINE	120 OZ
3063	PROLINE 480 SC	2.5 GAL
3074	QUADRIS TOP/ACADIA ESQ	2.5 GAL
2449	QUINTEC	30 OZ
2407	RALLY 40WSP	5 X 4 OZ
4096	RANMAN	1 GAL
2603	RANMAN	1 QT
2600	REVUS TOP	2.5 GAL
3120	REVUS	1 GAL

FUNGICIDES / BACTERIACIDES

ITEM	DESCRIPTION	SIZE (S)
3053	ACTIGARD 50 WG	7.5 OZ
2790	ACTINOVATE AG	18 OZ
12204	AFRAME	2.5 GAL
2980	AGRIMYCIN 50	3LB
12168	APPROVIA TOP	1 GAL
4123	BADGE SC	2.5 GAL
2935	BADGE X2, OMRI	10 LB
12269	BLOCKER, 4F	5 GAL
5155	BRAVO WEATHERSTICK, MA RUP	2.5 GAL
5156	BRAVO ULTREX, MA RUP	27.4 LB
2486	CABRIO EG	5 LBS
1652	CAPTAN 4L	2.5GAL
2327	CAPTAN 80WDG	6.25 LB
2382	CAPTAN 80WDG	30 LB
4542	DOUBLE NICKEL LC, OMRI	2.5 GAL
2379	ELEVATE 50 WDG	2 LB
3990	ENDURA	6.5 LB
4930	FERBAM	20 LB

FUNGICIDES/BACTERIACIDE (CONTINUED)

ITEM	DESCRIPTION	SIZE (S)
2489	RIDOMIL GOLD BRAVO, MA RUP	2.5 GAL
2548	RIDOMIL GOLD MZ	5 LB
2960	RIDOMIL GOLD SL	1 PT
468	RIDOMIL GOLD SL	1 GAL
10708	ROVRAL 4F	2.5 GAL
3088	SANIDATE 5.0	5 GAL
2381	SWITCH 62.5WG	28 OZ
3679	SYLLIT FL	2.5 GAL
2490	TANOS	7.5 LB
2353		2.5 GAL
2352	TOPSIN M WSB	5 X 1 LB
2606	TORINO - MA RUP	34 OZ
2962	VANGARD WG	50 OZ
4979	VIVANDO SC	1 GAL
4978	ZAMPRO	140 OZ
3047	ZIRAM 76DF	40 LB
2498	ZEROTOL 2.0	2.5 GAL

HERBICIDES

ITEM	DESCRIPTION	SIZE (S)
4909	ACCENT Q	18 OZ
10424	ACURON, RUP	2.5 GAL
5017	AIM EC	1 QT
2873	ALION	1 QT
4808	AQUASHADE	1 GAL
2952	ATRAZINE 4L, RUP	2.5 GAL
3879	ATRAZINE 90DF, RUP	25 LBS
2644	BANVEL	2.5 GAL
2406	BASAGRAN	2.5 GAL
2378	BICEP II MAGNUM RUP, nol.I.sales	2.5 GAL
2248	BULLZEYE GLYPHOSATE	2.5 GAL
2265	BULLZEYE GLYPHOSATE	30 GAL
5159	CALLISTO 4SC	1 GAL
463	CASORON 4G	50 LB
4479	CHATEAU SW	2.5 LB
4977	CLETHODIM 2EC	1 GAL
2373	COMMAND 3 ME	2.5 GAL
5107	CROSSBOW, MA RUP	1 GAL
5144	CROSSBOW, MA RUP	2.5 GAL
534	CUTRINE PLUS	1 GAL

HERBICIDES (CONTINUED)

ITEM	DESCRIPTION	SIZE (S)
10327	CUTRINE PLUS	2.5 GAL
2849	DEVTRINOL 2XT	2.5 GAL
2866	DEVTRINOL 50DF-XT	4 LB
3015	DUAL MAGNUM, MA RUP (NO L.I. SALES)	2.5 GAL
2618	FORMULA 40, MA RUP	2.5 GAL
5100	GARLON 3A	2.5 GAL
2374	GOAL 2XL	2.5 GAL
2646	IMPACT 2.8SC	30 OZ
13375	INTERLINE (NO L.I. SALES)	2.5 GAL
13074	KARMEX DF	5 LB
2484	LOROX DF	20LBS
496	LUMAX EZ, RUP (NO L.I. SALES)	2.5 GAL
2668	MATRIX SG	20 OZ
4295	MEDAL II EC, MA RUP (NO L.I. SALES)	2.5 GAL
446	POAST	2.5 GAL
4143	PRAMITOL 25	1 GAL
2464	PREFAR-4E	2.5 GAL
2376	PRINCEP CALIBER 90	10 LBS
2545	PROSEGE 2	1.33 OZ
2383	PROWL H20	2.5 GAL
474	QUINSTAR 4L	2.5 GAL
2334	REGLONE	2.5 GAL
502	ROUNDUP POWERMAX	2.5 GAL
2351	SANDEA	10 OZ
4059	SCYTHE	2.5 GAL
5148	SELECT MAX	2.5 GAL
4628	SIMAZINE 4L, MA RUP	2.5 GAL
2601	SINBAR 80WDG	5 LBS
2537	SOLICAM DF	10 LB
10354	SOTRION - MESOTRIONE	1 GAL
5151	STINGER	1 QT
1580	STRATEGY	2.5 GAL
12297	TRIFLURALIN 4EC	2.5 GAL
441	WEEDAR 64 BROADLEAF, MA RUP	2.5 GAL

INSECTICIDES

ITEM	DESCRIPTION	SIZES (S)
12930	ABAMECTIN 0.15EC RUP	1 GAL
10672	ACEPHATE 97UP	1LB
5016	ACEPHATE 97UP	10 LB
436	ACTARA RUP	30 OZ
5161	ADMIRE PRO	140 OZ
535	ALTACOR	16 OZ
2656	ASANA XL, RUP	1 GAL
3101	ASSAIL 30SG	4 LBS
14216	AVAUNT EVO	30 OZ
2946	BAYTHROID XL, RUP	1 GAL
4945	BELEAF 50SG	1.5 LB
4959	BLACKHAWK	64 OZ
2536	BESIEGE, RUP	2.5 GAL
4402	CARBARYL 4L	2.5 GAL
2325	CONSERVE SC, T&O INSECTICIDE	1 QT
2661	CORAGEN	1 QT
13842	CORAGEN	1 GAL
4642	COUNTER 20G LNL, RUP	40 LB
2350	DAMOIL	2.5 GAL
14176	DAMOIL	5 GAL
2317	DAMOIL	55 GAL
4141	DANITOL 2.4 EC, RUP	1 GAL
5154	DELEGATE WG	26 OZ
2547	DEADLINE BULLETS	50 LB

INSECTICIDES (CONTINUED)

ITEM	DESCRIPTION	SIZES (S)
433	DIAZINON AG500, RUP	2.5
472	DIAZINON AG600, RUP	2.5 GAL
10586	ESSENTRIA IC3 INSECTICIDE CONCENTRATE	1 GAL
3159	FULFILL	27.5 OZ
3636	IMIDAN 70W	5 LB
5152	INTREPID 2F, MA RUP	1 GAL
2410	LANNATE LV, RUP	2.5 GAL
2448	LANNATE SP, RUP	8 OZ
2375	LANNATE SP, RUP	32 OZ
5147	MALATHION 5EC	1 GAL
12147	MALATHION 5EC	2.5 GAL
3014	MOCAP 15G, RUP	30 LB
10517	MONTANA 2F	1 GAL
4065	MOSQUITO BARRIER	1 GAL
10751	MOVENTO	1 GAL
2680	MUSTANG MAX, RUP	1 GAL
2700	ONYXPRO, RUP	1 QT
2519	PERM-UP 3.2EC, RUP	1 GAL
13064	PLATINUM 75 SG (NO L.I. SALES) RUP	8 OZ
3962	RADIANT	1 QT
2663	RADIANT	1 GAL
5160	SEVIN XLR	2.5 GAL
3123	VENOM	1 LB
1579	WARRIOR II, RUP	1 GAL

MITICIDE

ITEM	DESCRIPTION	SIZES (S)
2617	ACRAMITE 50WS	1 LB
2969	APOLLO SC	1 QT
4117	NEALTA	137 OZ
449	NEXTER	33 OZ
5054	PORTAL XLO	2.5 GAL
2619	SAVEY 50 DF	12 OZ
3911	ZEAL MITICIDE WSP	12 OZ

PLANT GROWTH REGULATORS

ITEM	DESCRIPTION	SIZES (S)
2977	APOGEE	5 LB
2647	ETHREL	1 GAL
2512	FRUITONE L	1 GAL
2927	FRUITONE N	20 OZ
2959	MAXCEL	1 GAL
2945	PROMALIN	1 QT
2602	RETAIN	0.73 LB



EcoSwing®

BOTANICAL FUNGICIDE



CROPS

FRUITING VEGETABLES
 LEAFY VEGETABLES
 ROOT AND TUBER VEGETABLES
 BULB VEGETABLES
 HERBS AND SPICES
 BERRY AND SMALL FRUITS
 POME AND STONE FRUITS

See label for details and additional crops

DISEASES

POWDERY MILDEW
 BOTRYTIS
 MONILINIA
 BUNCH ROT COMPLEX
 ALTERNARIA
 SOUR ROT

Consult the EcoSwing® label for a complete list of crop uses and pests controlled

Use EcoSwing in a preventative manner before disease has reached an economic threshold. Use in a program approach every 7-10 days.

1.5-2
PTS/ACRE

4 hr
REI

0 day
PHI

EPA REGISTERED
TOLERANCE EXEMPT

FAVORABLE PROFILE FOR
 APPLICATORS, HANDLERS + FIELD WORKERS

FOR MORE INFORMATION

ALEX DECKEY

845-745-9246

ADECKEY@GOWANCO.COM

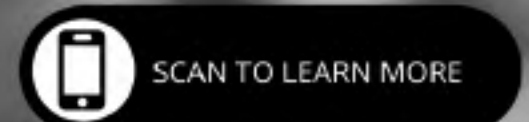

Ecoswing® is a registered trademark used under license by Gowan Company, L.L.C. Always read and follow label instructions.



SAFETY

SUNDSTROM MASKS

SR100 & SR200 masks are an Air Purifying Respirator (APR) made of silicone. The mask is equipped with two exhalation valves, which ensures very low exhalation resistance. The mask is used with SR307 compressed air attachment, this combination is called a Type C Continuous Flow Supplied Air Respirator (SAR).

SUNDSTROM MASK



ITEM	SIZE	PRICE
10470	SMALL/MEDIUM	\$58.60
10471	MEDIUM/LARGE	\$58.60
10472	LARGE/XLARGE	\$58.60

Pro-Pack SR100, 1/2 Mask Respirator.

SUNDSTROM MASK



ITEM	SIZE	PRICE
10469	ONE SIZE	\$240.90

Pro-Pack SR200, Full Mask Respirator.

SAFETY

Protecting Our Farmers and Farm Families

There are a number of respiratory hazards in the agricultural industry which include organic dusts, molds, bacteria, gases from fermentation of silage and manure, inorganic dusts, pesticides and other agricultural chemicals.



Sundström 

MEASURING PITCHER



ITEM	SIZE	PRICE
381	128 oz.	\$13.59
382	64 oz.	\$9.99
383	8oz.	\$7.69
1860	32 oz.	\$8.99
1859	16 oz.	\$8.09

Durable construction made from food grade Opolypopylene with steep resistance to a variety of chemicals. Measurement in US fl. Oz and metric debossed in black to be easily read. Excellent pouring control and provide entire control from a fine trickle to a fast pour.



FERTILIZER

* We can not ship product to a state where the product is not registered. Please inquire for pricing. *

CUSTOM BLENDS AVAILABLE

BLENDED FERTILIZERS - GRANULAR

ITEM	DESCRIPTION - ALL IN 50 LB BAGS
12506	5-15-30 FERTILIZER
4973	6-12-6 A/S 1% MG & .2% B, CAULIFLOWER
2844	7-7-7 BLUEBERRY FERTILIZER
2882	10-10-10 ASM
4953	10-20-10 ASM CROP STARTER
2793	10-20-20 ASM FERTILIZER
4952	13-13-13-12S FERTILIZER
4865	14-7-14 ASM FERTILIZER
10843	FERTILIZER 16-8-8-16S
4802	18-11-17 50% XCU
4867	18-8-18 CS CRANBERRY FERTILIZER
2597	19-19-19 FERTILIZER
4863	18-18-18 MICROS
2596	24-12-18 80%ESN
4799	28-7-14
4803	30-0-20 FERTILIZER

FERTILIZER INGREDIENTS

ITEM	DESCRIPTION - ALL IN 50 LB BAGS
14286	0-45-0 TRIPLE SUPER PHOSPHATE
2767/4470	0-0-22 KMAG / SUL-PO-MAG
539	0-0-50 POTASSIUM SULFATE/SULFATE OF POTASH
2578	0-0-60 POTASSIUM CHLORIDE/MURIATE OF POTASH
2828	11-52-0 MAP
480	21-0-0 AMM SULFATE GRANULAR
4928	46-0-0 UREA GRANULAR
10231	ALUMINUM SULFATE 17% 16%S
10218	BORON 10% GRANULAR
2908	CALCIUM NITRATE AG 15-0-0
3519	COPPER ZINC SULFATE 15% GRANULAR 6% S
3851	IRON SULFATE 50% FE, 5% S
3516	MANGANESE SULFATE 28% 6% S
3518	ZINC SULFATE 36% GRANULAR 5% S
4309	SULFUR 90G (TIGER)
14994	COBALT SULFATE

ASM DENOTES MADE WITH AMMONIUM SULFATE, MAP & MICRONUTRIENTS.

The market is very volatile this year. Please order your fertilizer as early as possible.



FERTILIZER



MASTERBLEND®

PREMIUM FERTILIZERS

Complete Solubility



Say goodbye to clogged lines, filters and injection systems.

Masterblend® is a premium-grade water-soluble fertilizer that completely dissolves in all types of water. Made with only the highest quality, technical-grade materials to deliver exceptional nutrition for optimal growth and healthier plants.

Contact Progressive for Available Formulations!



masterblend.com



FERTILIZER

FERTILIZER - SOLUBLE

ITEM	DESCRIPTION	SIZE (S)
15034	0-52-34 MONO POTASSIUM PHOSPHATE	50 LBS
2625	15-0-15 DARK WEATHER	25 LBS
2628	15-10-30 MUM FORMULA	25 LBS
2626	15-16-17 SOIL-LESS	25 LBS
14976	17-5-17 CAL-MAG	25 LBS
2630	17-6-6 ACID GREENING	25 LBS
2621/ 11847	20-10-20 ALL PURPOSE or SOIL-LESS	25 LBS
2622	20-20-20 ALL PURPOSE	25 LBS
3789	21-0-0 AMM SULFATE SPRAYABLE	50 LBS
3058	4-2-41-2Mg CROP FINISHER	25 LBS
2627	4-18-38 TOMATO FORMULA	25 LBS
4813	46-0-0 FEED GRADE UREA	50 LBS
2624	5-11-26 HYDROPONIC	25 LBS
3049	9-45-15 PLANT STARTER	25 LBS
14175	BORON 21%	44 LBS
5056	CALCIUM CHELATE	5 LBS
14854	CALCIUM NITRATE GREENHOUSE	55 LBS
4783	COPPER SULFATE FINE 25%	50 LBS
3065	IRON CHELATE DP 10%	5 LBS
1852	IRON SULFATE 20% FERROUS	50 LBS
3517	MAGNESIUM SULFATE (Epsom Salt)	55 LBS
3790	MANGANESE SULFATE 32% (Techmangan)	55 LBS
15050	MOLYBDENUM SODIUM MOLYBDATE	5 LBS
2583	POTASSIUM NITRATE GREENHOUSE	50 LBS
4535	ZINC SULFATE 35% ZN 17% S	50 LBS

SOIL AMENDMENTS

ITEM	DESCRIPTION, IN 50 LB BAGS
567	SOLU-CAL PLUS ENHANCED CALCIUM (GRANULAR)
4367	SOLU-CAL HUMIC PLUS
1861	SOLU-CAL S ENHANCED GYPSUM (GRANULAR)
2852	PULVERIZED/AG LIME HI-MAG
5087	HYDRATED LIME, HI-MAG
12995	HYDRATED LIME, HI CAL
13523	PELLETIZED LIME, HI-CAL
13522	PELLETIZED LIME, HI MAG
12412	PELLETIZED GYPSUM
11979	PULVERIZED GYPSUM

We are constantly adding to our inventory.

Please contact us if you don't see what you are looking for.





GROWMARK FS, LLC

IN THE BUSINESS OF IMPROVING YOUR BOTTOM LINE

CROP PROTECTION

SEED

CROP NUTRIENTS



Solu-Cal
Powered by *INTENSIFY* Microbial BioCatalyst

Solu-Cal has solutions for:

- Same-season soil pH adjustment
- Immediately available Calcium
- Micronutrients
- Biologicals for soil health

Easy, Effective, and Efficient
Applications for all Crop & Turf
Needs

**CHOOSE GROWMARK FS PRODUCTS TO
INCREASE YIELDS AND GROW YOUR PROFITABILITY**



POWERED BY GROWMARK FS AGRONOMY





King's AgriSeeds^{Inc.}

FEEDING YOUR FARM'S FUTURE.

- **COVER CROPS**
- **WINTER ANNUALS**
- **SUMMER ANNUALS**
- **PERENNIAL MIXTURES**
- **GRAND CHAMPTION
KINGFISHER CORN HYBRIDS**
- **POLLINATOR MIXTURES**
- **AND MORE**

**Place your spring order with
Progressive Grower, today!**

Visit kingsagriseeds.com for more information

717-687-6224



**Healing the Earth and
Feeding the World
- *Better Naturally!***

Fertrell[®]

SINCE 1946

Better Naturally!

**Natural and Organic
Fertilizers & Feed Supplements**

**Products are available through Progressive Grower.
81 Charlotte Furnace Road, West Wareham, MA 02576
844-357-6617 www.progressivegrower.com**



PROGRESSIVE GROWER
carries a vast amount of organic offerings.

We are proud dealers for
Fertrell, Kreher's, Nature's Safe

*We are constantly adding to our inventory.
Please reach out to us if you don't see something
in our catalog.*

While we do our best to research all of our products for use by organic growers, it is the responsibility of the farmer to determine if they pass USDA organic requirements before purchasing and using them. Some products that have OMRI or Nat'l List status can lose that standing at any time without notice. We are not responsible for products purchased that can not be used in certified OG operations. Check with your certifying agency for current status of a product. Not all of the products that we sell are registered in every state. It is your responsibility to comply with the laws of your state. Please check with your state department of agriculture if you are unsure.

**PRICES IN THIS CATALOG ARE SUBJECT TO
CHANGE WITHOUT NOTICE.**



ORGANIC PRODUCTS



- Rich in Organic Matter and Nutrients
- Helps Condition and Enrich Soil
- Available in Bulk, Totes and Bags

Organic Compost & Fertilizer

For decades, our family has used the manure from our laying hens as a crop fertilizer on our farm.



Scan to Learn More



Today, we are pleased to offer a variety of composted layer manure and dry, granular fertilizer blends for use in organic crop production

- 5-4-3 OMRI Listed
- 8-2-2 Blend
- 4-3-10 Blend
- 7-2-6 Blend

ORGANIC PRODUCTS

Progressive Grower is a valued supplier of

Kreher's Fertilizers

8-2-2

ITEM NO.	SIZE	PRICE
3553	50 LB BAG	\$29.95
3568	2000 LB SUPER SAC	\$1045.00

Made from a blend of composted poultry manure and feather meal. Can be used for new turf, established lawns, and vegetables. Contains 8% nitrogen, 2% phosphate, and 2% soluble potash.

5-4-3 WITH 9% CALCIUM

ITEM	SIZE	PRICE
13785	40 LB BAG	\$14.55
4641	2000 LB SUPER SAC	\$550.00

Made from composted poultry manure with no other ingredients. Can be used on vegetables, trees, shrubs, flowers, and turf. Contains 5% nitrogen, 4% phosphate, 3% soluble potash, and 9% calcium. Quantities limited. Please order in advance.

7-2-6

ITEM	SIZE	PRICE
13411	50 LB BAG	\$31.95
13410	2000 LBS SUPER SAC	\$1045.00

Made from composted poultry manure organically approved feather meal, OMRI blood meal and OMRI SOP.

4-3-10

ITEM NO.	SIZE	PRICE
3525	50 LB BAG	\$22.95
10230	2000 LB Super Sac	\$750.00

Made from composted poultry manure and sulfate of potash. Good as a starter fertilizer for corn crop. Can be used on vegetables, trees, shrubs, and flowers. 4% Nitrogen, 3% phosphate and 10% soluble potash *Call for availability.

5-4-3 SUNRISE

ITEM NO.	SIZE	PRICE
3569	50 LB Bag	\$18.50

Made from composted poultry manure and because of the dietary requirements of the hens it comes from, it contains higher amounts of calcium.

QUANTITY DISCOUNT AVAILABLE

PLEASE INQUIRE!



Neptune's Harvest fish hydrolysate is an all organic, highly nutritional protein fertilizer, made utilizing naturally occurring enzymes present in fresh North Atlantic fish. It's produced using a cold process employing enzymes (natural biological catalyst) which break down fish frames (the part left after the fillet is removed for human consumption) to simpler protein complexes. This process is called Hydrolysis.

The only manipulation the product goes through is stabilization with Phosphoric Acid to bring the pH down to 3.5, grinding, and hydrolysis. This process yields a stable, non-odorous, liquid fertilizer that is an easy to use, safe product. The nitrogen in Neptune's Harvest fish fertilizer is derived from fish protein in the form of amino acids which when added to the soil, slowly break down into basic nitrogen compounds. While a percentage of nitrogen becomes soluble due to the nature of the manufacturing process, no inorganic nitrogen has been added.

Fish Fertilizer 2-4-1

Fish & Seaweed Fertilizer 2-3-1

Seaweed Fertilizer 0-0-1

***Tomato & Vegetable Fertilizer 2-4-2**

**Meets NOP Standards*

ALL AVAILABLE IN

- 1 Gallon Container
- 5 Gallon Bucket
- 55 Gallon Bulk Drum
- 275 Gallon Tote



NEPTUNE'S HARVEST PRICING

ITEM	FISH FERTILIZER	PRICE
12221	1 Gallon Jug	\$29.85
3870	5 Gallon Bucket	\$114.95
3916	55 Gallon Drum	\$438.45
3872	275 Gallon Tote	\$2,049.95

ITEM	FISH & SEAWEED FERTILIZER	PRICE
4631	1 Gallon Jug	\$33.95
3871	5 Gallon Bucket	\$129.95
4736	55 Gallon Drum	\$595.95
13403	275 Gallon Tote	\$2,759.85

ITEM	SEAWEED FERTILIZER	PRICE
4837	1 Gallon Jug	\$29.95
11724	5 Gallon Bucket	\$128.95
4403	55 Gallon Drum	\$557.35
4404	275 Gallon Tote	\$2429.75

ITEM	TOMATO & VEGETABLE FERTILIZER	PRICE
13195	1 Gallon Jug	\$44.95
11969	5 Gallon Bucket	\$144.95
13579	55 Gallon Drum	\$1,195.85
TBD	275 Gallon Tote	CALL

We are also proud to carry Neptune's Crab & Lobster Meal and Kelp Meal.

GENERAL FERTILIZERS

GRANULAR

ALFALFA MEAL 3-1-2, 50 LB BAG



ITEM NO.	PRICE
4573	\$31.95

Dehydrated alfalfa has a high nutritional value and can be fed to a variety of livestock, poultry and horses. USDA Organic.

CRAB AND LOBSTER SHELL 2.5-3-0.5



ITEM	DESCRIPTION	PRICE
14702	SHELL COARSE, 12 LBS	CALL
13018	SHELL COARSE, 44 LBS	\$66.95
10226	SHELL FLOUR, 44 LBS	\$68.95

An excellent dry organic source of nutrients including Calcium and Magnesium. It retains moisture in the soil and builds the organic matter. It also gives the roots something to grab onto and wrap around for a food source, creating a deeper root system. Crab Shell will also keep slugs and snails off and it will help choke out weeds and keep moles, voles, mice, etc from digging up bulbs and root vegetables.

SUPER K, 3-4-7 + 2, 50 LB



ITEM	DESCRIPTION	PRICE
12812	3 - 4 - 7	\$39.50
12842	3 - 4 - 7 WITH BORON	\$41.65
10345	3 - 4 - 7 WITH BORON & ZINC	\$43.65

Blended with crab meal for nematode control and high natural potassium required for larger fruited vegetables, Not OMRI certified.

FISH MEAL 50 LB BAG



ITEM NO.	PRICE
4115	\$76.95

A great natural fertilizer that is high in phosphorus and nitrogen. Fish meal is quick acting and offers a sustained supply of nutrients. Do not scatter fish meal, but plug it in a series of holes 10" deep that can be covered with about 4" of soil, as it has a strong odor.



ITEM	DESCRIPTION	SIZE	PRICE
4464	10-2-8 COARSE	50 LB	\$39.85
12072	10-2-8 COARSE	2000 LB	\$1445.65
12691	13-0-0 COARSE	50 LB	\$38.95
OMRI certified.			

See page 20 for Kreher's fertilizer options.

CUSTOM MIXES ARE AVAILABLE.

LIQUID

FERTRELL 3-4-3



ITEM	SIZE	PRICE
3793	1 GALLON	\$29.75

Made with kelp and humates. Not OMRI certified.

NATURE'S SOURCE 3-1-1, 4.7 GALLON JUG



ITEM NO.	PRICE
4565	\$73.95

Ideal for a wide range of crops, promotes rapid nutrient response and hearty plant growth. Contains oilseed extract and has a low salt index. May be used as a foliar mist without worrying about burning or stretch. Mixes easily with cold water and has no strong odor.

Ask about 55 gallon and 275 gallon sizes. OMRI certified.



SEE PAGE 21 FOR
NEPTUNE'S HARVEST
LIQUID FERTILIZER
OPTIONS.



CHECK OUT NATURE SAFE
BUY OR SHOP BY BRAND
OPTION AT
PROGRESSIVEGROWER.COM

NITROGEN

NITRATE OF SODA 15-0-2, 50 LB BAG



ITEM NO.	PRICE
3011	\$48.85

Contains 15% of nitrate nitrogen, it improves the nutritional quality of crops by increasing protein, albumin, amino acids, vitamin B and micronutrient content. Nitrate of Soda also contains iodine and selenium, essential elements for human health.
OMRI

FEATHER MEAL 13-0-0, 50 LB BAG

ITEM NO.	PRICE
5117	\$54.00

Good for crops that need steady, long lasting nitrogen. Because of its low water solubility, leaching is almost nonexistent. The nitrogen becomes available to plants through microbial activity. 13-0-0
OMRI

BLOOD MEAL 12-0-0, 50 LB BAG



ITEM NO.	PRICE
3164	\$74.95

A fast release source of organic nitrogen. It should only be used on plants that have a high nitrogen requirement. Can also be used in compost piles to increase the speed of the decomposition process and also tends to act as a deer repellent.
OMRI

PEANUT MEAL 8-1-1, 50 LB BAG



ITEM NO.	PRICE
3008	\$33.50

Medium release nitrogen.
OMRI

PHOSPHORUS

BONE CHAR IS NOT AVAILABLE THIS YEAR.

CALPHOS 0-3-0 20% CA, 50 LB BAG

ITEM	PRICE
4331	\$21.95

Pure mined rock phosphate for all flowering plants. Rock phosphate promotes root regrowth and is all natural and easy to apply. MAY BE LIMITED AVAILABILITY - PLEASE CONFIRM AVAILABILITY AT ORDER TIME.
OMRI

PHOSTRELL 0-6-0, 50 LB BAG

ITEM	PRICE
12555	\$34.50

This is a unique blend of bone char and aragonite providing a high level of phosphorus and calcium.
Not OMRI Certified.

POTASSIUM

SULFATE OF POTASH 0-0-52 SOLUBLE, 50 LB BAG



ITEM NO.	PRICE
4332	\$47.95

Is a mined rock that provides potassium and readily available sulfur. Soluble form for fertigation. Sulfate.
OMRI

SULFATE OF POTASH 0-0-50 GRANULAR

ITEM	SIZE	PRICE
4920	50 LB BAG	\$37.50
13513	1 TON	\$1450.00

0-0-50 SOP Granular OMRI. A white granule that provides 50% potash and 17% sulfur to crops. It is chloride-free and has a low salt index, less than half that of Muriate of Potash. Potassium Sulfate is suitable for applications into fertility systems primarily for grapevines, tree crops, and vegetables.
OMRI

SUL-PO-MAG 0-0-22 SOLUBLE, 50 LBS

ITEM NO.	PRICE
4895	\$43.95

Made of a soluble sulfate of potash magnesia. Apply the crushed mineral in areas where magnesium and potassium are deficient and calcium is abundant. Soil pH will remain the same.
OMRI

SOIL AMENDMENTS

KELP MEAL 50 LB BAG



ITEM NO.	PRICE
3570	\$84.95

For soil nutrients: contains 60+ macro and trace minerals, vitamins, carbohydrates, plant growth hormones and a complex of 17 amino acids, nutrients are almost 100% available, can stimulate root development and plant growth, and helps retain soil moisture and reduces the effects of frost.
OMRI

PLEASE SEE PAGE 21 FOR LIQUID FERTILIZER OPTIONS. WE ARE ALWAYS ADDING TO OUR INVENTORY.



NOTES

ORGANIC PRODUCTS

MICRO/MACRO NUTRIENTS

WORM CASTINGS, 25 LB BAG



ITEM NO.	PRICE
14190	\$32.95

WORM CASTINGS, 30 LBS. This soil amendment provides a rich mixture of micronutrients, microbes and organic matter. It has an almost equal percentage of nitrogen, phosphorus and potassium. Calcium and magnesium are present as well. Use as a plant top dressing or add it to potting mix, houseplants, and raised beds. OMRI

ARAGONITE, 50 LB BAG



ITEM NO.		PRICE
13023	COARSE GRADE	\$17.95
3791	FLOUR GRADE	\$18.95

Apply to the soil for a highly available source of calcium and trace minerals. Made of marl, which comes from the ocean. OMRI

MANGANESE SULFATE 0-0-0-18-32, 55 LB



ITEM NO.	PRICE
3790	CALL

For soils deficient in Manganese, apply this fast acting source of Manganese to the soil preplant or at planting. **Water Soluble.** OMRI

SULFUR



ITEM	DESCRIPTION	PRICE
2399	PASTILLE, 90%, 50 LBS	\$31.00
4309	TIGER, 90%, 50 LBS	\$31.00

Improved handling, high quality degradability and performance, soil amendment for alkaline soils, reduces soil pH. OMRI Listed

BORON 10%, 0-0-0-10, 50 LB BAG

ITEM	PRICE
10218	\$31.95

Derived from sodium calcium borate, non-acid forming. Side dress plants or broadcast across the garden. OMRI

AZOMITE GRANULATED NATURAL TRACE MINERALS, 44 LB BAG



ITEM NO.	PRICE
3446	36.95

Granulated AZOMITE is a natural mineral product mined from an ancient deposit in central Utah that is highly rich in trace minerals. A typical analysis reveals the presence of over 70 trace minerals that are both essential and beneficial to all plants. These minerals are often deficient in the neglected in fertilizers. Adding Granulated AZOMITE to the soil increases the trace minerals plants need, and gives a big boost in fruit and vegetable yield, flowering, and overall health and vigor of plants. Granulated AZOMITE is certified for organic use and is sold in a convenient 44 lb. bag for your lawn, garden, trees, or field crops in a non-dusty granule, suitable for use in broadcast spreaders or by hand. It is compatible for all organic gardening or farming programs. OMRI

SOIL & PLANT ENHANCERS

**PLEASE CALL ABOUT HUMIC ACID/
HUMATE OPTIONS!**

ZEOLITE, 50 LB BAG



ITEM NO.	PRICE
5118	\$34.95

Will cut fertilizer and water costs by holding the nutrients and water in the root zone until the plant is ready to utilize them, requiring less fertilizer and water to be applied. When used properly, Zeolite can also yield impressive results in regards to faster germination times, faster growth rates, larger plants, and crop yields and reduced fertilizer and water applications. OMRI

FUNGICIDES

ROOTSHIELD PLUS WP



ITEM	SIZE	PRICE
11655	1 LB	CALL
2917	3 LB	CALL

Grows on roots, shielding them against root-damaging fungi, controls up to 12 weeks, and prevents control of major root diseases including soilborne Phytophthora sp. 0 hour REI 0 day PHI.

PURESPRAY GREEN



ITEM	PRICE
10390 2.5 Gallon	\$57.00
10391 30 Gallon	\$595.00

Reduces the risk of leaf burn, the only spray oil listed by OMRI for use in organic production in the National Organic Program. Apply throughout the growing season, when done, it biodegrades leaving no harmful chemical residues.

MILSTOP, 5 LBS

ITEM	PRICE
4119	\$69.95

Potassium bicarbonate based with added surfactants for superior performance.

KALIGREEN, 5 LB BAG



ITEM NO.	PRICE
4235	\$58.95

Kaligreen is a contact-type fungicide for the control of powdery mildew. It contains microencapsulated potassium bicarbonate as the active ingredient and direct contact with the fungus is necessary for control. Potassium ion balance in the fungus cell is broken by Kaligreen; cell walls collapse, shrinking the cells and destroying the fungus.

DOUBLE NICKEL



ITEM	PRICE
3181 5 LBS.	\$173.75
4542 2.5 GALLONS	\$198.75

For use on fruit and vegetable crops as a broad spectrum preventive biofungicide for control of fungal and bacterial plant diseases. Can be applied up to and including the day of harvest. OMRI

REGALIA 2.5 GALLON



ITEM NO.	PRICE
2636	\$194.65

Regalia stimulates the plant's innate ability to fight diseases and delivers better yield and improved harvest quality. Offers preventative activity and early control of yield-robbing diseases and is recommended for use in specialty crops. OMRI

NU-COP HB, 10 LB

ITEM	PRICE
4080	\$68.95

Nu-Cop HB provides the most bio-available copper ions of any copper fungicide on the market to provide better disease control. For use on fruits, vines, berries, vegetables, nuts, and several field crops.

SERENADE ASO, 2.5 GAL.



ITEM	PRICE
2130	\$125.00

Applied as a preventative fungicide. Provides fungal and bacterial protection for all sized gardens. Use on roses, vegetables, fruits, flowering plants, trees and shrubs. Controls powdery mildew, rust, gray mold.

BADGE X2, 10 LB BAG



ITEM	DESCRIPTION	PRICE
2935	Organic	\$72.95

Advanced copper technology, Badge X2 is a low load dry copper formulation that is a mixture of two high purity copper salts, copper oxychloride and copper hydroxide. Known for its fast action and crop safety, possesses highly micronized and uniform copper particles resulting in increased adhesion to the plant surface. Highly water soluble dry formulation.

INSECTICIDES

ENTRUST SC, 1 QT



ITEM NO.	PRICE
2447	Call

Produced through the fermentation of spiroasad, Entrust SC provides control of a huge range of insects. Registered for use on organically produced crops, it demonstrates good activity against pests like army worms, thrips, leaf-miners, codling moth, cherry fruit flies and Spotted Wing Drosophila. Provides pest specific control with a relatively low toxicity to nontarget organisms, including many beneficial insects. It won't cause a flare in mites, aphids, or other secondary pests. It is the only OMRI listed product that effectively controls worms, thrips and leaf-miners. Four hour re-entry interval.

ORG SLUGGO 1% IRON PHOSPHATE, 50 LB BAG



ITEM NO.	PRICE
10714	\$175.65

Contains 1% iron phosphate and 99% inert ingredients. Considered safe for humans and pets. Ingestion of Sluggo by slugs or snails will cause them to cease feeding, become less mobile and die.

MYCOTROL ESO, 1 QUART



ITEM NO.	PRICE
4505	\$148.75

Controls adult and immature stages of aphids, thrips, whitefly and more. Can be used in greenhouses, nurseries, for veget auveria-containing insecticide. Unique mode of action- spores infect directly through the insects cuticle.

DIATOMACEOUS EARTH, 50 LBS

ITEM NO.	PRICE
4838	\$33.95

This fossilized diatom flour is abrasive and absorptive, razor sharp at the microscopic level, physically wears through insects' waxy outer cuticle. Absorbs insect's body fluids until it dies from dehydration, insects cannot develop immunity, less, odorless and permanent.

SURROUND WP 25 LB

ITEM NO.	PRICE
2450	\$38.50



Derived from kaolin clay, Surround WP forms a barrier film that acts as a broad spectrum crop protectant. It is labeled to control insect pests and disease while protecting against sunburn and heat stress. Coats the plants with a white powder film that creates a hostile environment for insects and mites and acts as an irritant and the film creates a physical barrier to insects like psylla. For use on trees such as apples, pears, peaches, citrus, berries, and some field crops. Needs to be applied before pests arrive.

PYGANIC



ITEM		PRICE
4116	1.4 II, QUART	\$69.95
2446	1.4 II, GALLON	\$216.95
11725	5.0 EC, QUART	\$179.95
2387	5.0 EC, GALLON	\$595.95

PyGanic provides immediate insect control for organic farming and provides immediate control of more than 40 insects on over 200 crops. It's active ingredient is a botanical extract from a species of chrysanthemum plant family called pyrethrum. Pyrethrum provides fast knockdown and control of a broad spectrum of crop-damaging insects including aphids, leafhoppers, thrips, mites, beetles, Lepidoptera and whitefly.

DIPEL DF



ITEM NO.		PRICE
2487	1 LB	\$18.95
4982	5 LB	\$87.50

Dissolves better in water than wettable powders. Granulated, no dust or clumping when mixed. Specific to leaf eating caterpillars, DiPel controls gypsy moth tent caterpillars, cabbage looper, tomato hornworm, leafroller, and more. For use on vegetables, fruits, flowers, ornamentals, and lawns. Harmless to humans, animals, and beneficial insects.

TRILOGY (NEEM OIL), 2.5 GALLONS

ITEM NO.	PRICE
10838	CALL

Trilogy prevents fungal attack of plant tissue and contact activity to mite pressure on the plant. Call for availability.

AZAGUARD

ITEM NO.		PRICE
12187	32 OZ	\$159.85
13254	1 GAL	\$489.95

Broad spectrum insecticidal control on over 300 insect species.

AZERA

ITEM NO.		PRICE
4058	GALLON	\$454.00

Controls insects through three modes of action: contact, ingestion and insect growth regulatory activity.

BLOCERES WP, 16 OZ

ITEM	PRICE
4632	\$98.95

HERBICIDE SUPPRESS EC, 2.5 GALLON



ITEM NO.	PRICE
10222	\$229.00

A broad spectrum contact herbicide for post-emergent, non-selective weed control for use in and around all agricultural food and non-food crops. The formulation is a non-volatile, emulsifiable concentrate that provides rapid, effective control for various weeds.



Progressive Grower is a proud dealer of Rain-Flo Equipment.
Please call for quotes.





WATER WHEEL TRANSPLANTERS

Water Wheel Transplanter passes over a completed plastic mulch bed (performs equally well in raised or flatbed applications) planting wheel punches and waters the hole completely, and allows the operators, riding in a comfortable position to place a plug, potted or bare root plant directly into the watered hole. Plant mortality is kept extremely minimal.

COMPACT DESIGN

Allows closer row centers, shorter turns and increases water and tray carrying capacities of a smaller tractor.

Floating wheel bracket, plant up to 3 rows (1-2 standard) per bed, optional 3 wheel plumbing for 3 rows. Standard racks allow total carrying capacity of 19 standard 1020 trays. 25 trays with optional second top rack. Fully adjustable comfortable high back cushioned seats with footrest for greater operator efficiency. Tank has a shut-off valve that can be reached by the planter personnel. Water flow into planter wheels can be adjusted independently.



ITEM NO.	PRICE
Model P1500 Combination	Call for quote

Pull-type with large transport wheels. It converts easily to 3-point hookup by pulling 3 pins & dropping the hitch. Has an adjustable turnbuckle on hitch for easy leveling. Used tires with new rims. Steel wheels optional. 150 gallon tank.

ITEM NO.	PRICE
Model P150 3-point Hookup	Call for quote

3 Point allows for tighter turn radius at the end of the row. Cat 1 & 2 lift pins. Requires tractor with lift capacity of almost 3000 lbs. 40-80 hp, 4WD or loader help. 150 gallon tank.

Order planting wheels separate = NOT INCLUDED WITH UNIT PRICE

Both models feature quick and easy wrench free seat and unit height adjustment. Open back makes planting wheel changes easy, no bar to lift.

Stock Planting Wheels, C spike - choose spacing: 12, 15, 18, 24, 30, 36, 42, 48"

Custom Planting Wheels - choose spacing & spike

Adjustable spacing SUPER WHEEL for Snap-on Spikes (Order Spikes Separately)

Number of spikes = approx. spacing (i.e. for PWS26 you need 18 spikes for 6" spacing)

PWS24 12=8", 6=16", 4=22", 3=28", 2=40", 1=77"

PWS26 18=6", 9=12", 6=17", 3=31", 2=45", 1=86"

PWS30 24=5", 12=10", 8=14", 6=19", 4=27", 3=35", 2=51", 1=98"

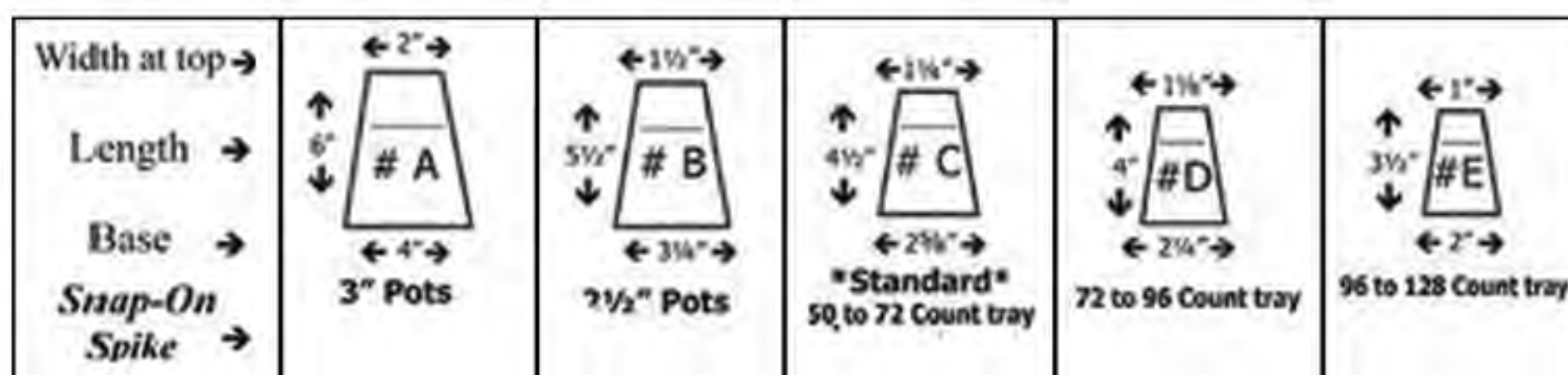

BUILD YOUR DREAM GARDEN



*Model 749
w/ Rotary Plow*

Build raised beds with a BCS Two-Wheel Tractor and Rotary Plow attachment!



Rotary Plow - Four spiral blades spin at 290 RPM on a vertical shaft, easily busting sod or hardpan soil.



Spreader - Saves time and effort while increasing distribution efficiency. Forget about wheelbarrows, shovels, and rakes!

With other attachments, BCS will till, chip limbs, mow, blow snow, and more!



- Financing Available.
- All-gear driven.
- Front & rear mount attachments.
- Lifetime transmission warranty.

www.bcsamerica.com

EQUIPMENT



TWO-WHEEL TRACTORS ONE TRACTOR. MANY USES. ALL MODELS AVAILABLE

BCS TRACTOR: HARVESTER 722 RECOIL

\$3,749.00



One of BCS's most popular models, the Harvester 722 is an excellent choice for those who want a combination of performance and versatility and don't foresee the need for the larger range of attachments powered by the Professional Series models. The 722 is powered with a Honda GX240 engine, two forward and reverse speeds, and an additional third transport speed when in rear-mount attachment mode. Ideal for adding an array of attachments such as the 26" Rear-Tine Tiller, 45" Sickle Bar Mower, Chipper/Shredder, Log Splitter, Dozer Blade and more. This model is limited in brush mowing applications due to its lack of a third working speed and Differential Drive. Battery not included.

- Easy-to-engage, shuttle-type reverse
- Anti-vibe handlebars that instantly adjust both vertically and side-to-side
- Fast transport speed
- Roto Tiller not included

BCS TRACTOR: PROFESSIONAL SERIES POWERSAFE 739 RECOIL

\$5,269.00

BCS TRACTOR: PROFESSIONAL SERIES POWERSAFE 739 ELECTRIC START

\$5,669.00



The PowerSafe model 739 features the coveted third working speed, giving owners increased operating efficiency with a faster, 2.7 MPH mowing speed. In addition to its three forward and three reverse speeds, the 739 also features turn-on-a-dime maneuverability with Differential Drive with Lockout. The 739 features the Honda GX340 engine, available in recoil or electric start. The 739's PowerSafe clutch differs from standard models by utilizing a hydro-mechanical "wet" clutch instead of the spring-loaded, double-cone clutch. More difficult to overheat sitting in an oil bath and cooled by circulated oil instead of air, it's also better suited for implements requiring higher torque, such as the Flail Mower or Chipper/Shredder. The PowerSafe clutch is longer-lasting, backed by a five-year warranty for non-commercial users. Get smoother shifting, safer operation, and immediate stoppage when the clutch lever is released. As with all PowerSafe models, the 739 does not have a transport speed.

- Differential Drive with Lockout
- PowerSafe clutch for longer life and smoother operation
- Separate control to turn engine off
- Battery not included for electric start tractors
- Roto Tiller not included
- Three working speeds in both directions
- Stops power to the implement when the safety lever is released without shutting down the engine



BCS TRACTOR: 732 MODEL (PS) RECOIL

\$4,149.00

BCS TRACTOR: 732 MODEL (PS) ELECTRIC START

\$4,499.00

BCS Model 732 is the most economical tractor offered with Differential Drive, with more features, more horsepower, and more versatility than straight axle models. The 732 is powered by Kohler's Command Pro CH395 engine and can accommodate a range of attachments like 26" tiller, 26" rotary plow and 53" sickle bar mower.

- Differential Drive with Lockout
- All gear drive
- Double cone clutch
- Convenient shuttle-style forward/reverse

BCS TRACTOR: MODEL 853 PROFESSIONAL SERIES BCS RECOIL

\$5,999

BCS TRACTOR: MODEL 853 PROFESSIONAL SERIES BCS ELECTRIC START

\$6,499



Powered by a Honda GX390 engine with recoil and electric start options, the 853 is BCS' most versatile tractor. Combining the best of both worlds, it offers a third working speed AND a fourth transport speed for maximum versatility. The BCS 853 gives you sufficient horsepower for all of the BCS implements, while also having the option of riding transport attachments like the utility trailer. In addition to the Differential Drive with Lockout being standard on all BCS Professional Series models, the 853 also features individual wheel brakes for increased maneuverability—especially helpful when making frequent turns. Transport speed can only be applied in rear-mount mode (tiller) on the 853.

- Fast transport speed for all rear-mount attachments
- Individual wheel brakes for turning and parking.
- Anti-vibe handlebars that instantly adjust both vertically and side-to-side
- Roto Tiller not included
- Differential Drive with Lockout
- Easy-to-engage, shuttle-type reverse
- Battery not included for electric start tractors

BCS TRACTORS: WITH DOZENS OF ATTACHMENTS



REAR TINE TILLER ATTACHMENT, 20"	\$899
REAR TINE TILLER ATTACHMENT, 26"	\$1,149
REAR TINE TILLER ATTACHMENT, 30"	\$1,194

- Tines rotate 50% faster than competitive brands at a rate of 20 rotations per wheel revolution
- Tine speed can also be adjusted to a 10:1 rotation ratio when in second gear
- Planar wedge in center of tiller breaks up center soil, leaving no un-tilled strip down the middle
- Tine disconnect with lockout stops tines from spinning during transport or when in reverse for safe operation
- Four tine depth settings, maximum of 8" tilled depth
- Replacement tine kits available



320 POWER HARROW, 21"	\$2,749
320 POWER HARROW, 30"	\$2,849
320 POWER HARROW, 32"	\$2,949

The Power Harrow is the preferred seedbed preparation tool by many market gardeners. While the traditional BCS Rear-Tine Tiller mixes the soil with its vertically rotating tines, the Power Harrow's knives turn horizontally, stirring the soil like an eggbeater.

- Helps preserve soil structure by creating a larger particle size than that produced by the tiller
- Reduces weed seed germination by not bringing a new generation of seeds to the surface
- Gently levels and compacts the bed with its metal mesh roller

Now featuring the exclusive adjusting "Josephine" lever, the Power Harrow is easy to turn at the end of rows. The easy-to-use lever enables the operator to quickly reach the transport position at the end of the row. After the turn, the desired depth is re-established by returning the lever handle to its previous notch. The Power Harrow's tine depth can be easily adjusted from 0 inches to 5 inches and also includes an integrated tang at the PTO connection point. The integrated tang has a wider bolt hole for the female tractor bushing, which provides a side-to-side "float" on uneven terrain. The gentle compaction of the mesh roller improves the performance of mechanical seeders. The roller also benefits the landscape industry by leveling uneven ground.

Required Accessory: *Bumper Weight Kit for easier turning at the end of the row. A Quick Hitch Bushing is required.*



360 ROTARY PLOW SINGLE	\$1,899
360 ROTARY PLOW SWIVEL	\$3,099

This unique attachment is world-renowned for its superior performance, versatility and easy handling. Designed in Italy and nicknamed the "Groundblaster", the Rotary Plow accomplishes a multitude of tasks efficiently and effectively.

Four spiral blades spin at 290 RPMs on a vertical shaft, digging effortlessly into all types of soil — including hardened, rock-filled dirt that has yet to be broken. Debris is discharged to the right side, allowing the operator to build raised beds with multiple passes. The Rotary Plow engages the ground up to 12" deep, and can be regulated by a depth wheel that also provides easy transportation. The Rotary Plow can accomplish these tasks and more:

- | | |
|-----------------------------|--|
| • Break new ground | • Create drainage ditches |
| • Power compost cover crops | • Power hilling |
| • Build raised beds | • Required Accessory: Wheel Extensions |

EQUIPMENT



SUPER DELUXE FLATBED MULCH LAYER



Model SL43 with optional Drip Attachment



Model SL5450 Combination Sweet Corn Model

OUR TOP OF THE LINE SUPER DELUXE MULCH LAYERS FEATURE:

Heavy duty spring loaded drag gives a smooth, pressed seed bed and eliminates pot holes.

Furrow openers on bottom of drag give a consistent depth furrow and can't be pushed out off line by rocks.

High speed dirt shields

Drag is easy to remove for laying clear plastic over top of planted sweet corn or raised beds

Adjustable spring tension on plastic roll, 3" roller and 16" rubber tire press wheels keep plastic under constant pressure resulting in uniform and tightly laid mulch.

The cover disks are independently spring loaded and are fully adjustable.

Extra roll carrier enables machine to carry 2 - 4000' rolls of plastic mulch.

COMBINATION MODEL

Pull type with large transport wheels converts easily to 3 Pt Hookup by pulling 3 pins and removing the hitch. Spring assisted lever makes it easy to raise and lower the machine by hand when using it as a pull type. With used rubber tires and new rims. Steel transport wheels are optional for additional \$ 65.00

A FREIGHT CHARGE WILL APPLY TO ALL PRICES LISTED.

13748 Model SL43 3 Pt Hookup	Adjustable, Lays 4 or 3 ft plastic	\$ 1350.00
3747 Model SL54 3 Pt Hookup	Adjustable, Lays 5 or 4 ft plastic	\$ 1550.00
Model SL4300 Combination Model	Adjustable, Lays 4 or 3 ft plastic	\$ 2100.00
Model SL5450 Combination Sweet Corn Model	Adjustable lays 4 & 5 ft. plastic over sweet corn ridges. Furrow Opening Disks included	\$2090.00
SLP04+SLP02	Optional 4' Drag & Hangers for Model SL5450 for laying 4 ft. plastic flat	\$ 200.00

OPTIONAL ACCESSORIES

DRIP IRRIGATION ATTACHMENT	Fully adjustable drip feed-in tube. Roll carrier shaft is mounted on ball bearings, this prevents shaft from tearing into drip roll hubs. Adjustable brake gives accurate tension control and prevents drip roll from unwinding freely when machine stops.	13749	\$ 225.00
Double DRIP IRRIGATION ATTACHMENT		SLA2	\$ 390.00
ADJUSTABLE ROW MARKERS	Fits on all models	SLA4	\$ 110.00
CUSHIONED SEAT	Allows a helper to ride along to watch machine and change rolls	SLA3	\$ 150.00
FURROW OPENING DISKS	To lay clear plastic over planted sweet corn	3748	\$ 350.00
Stainless Steel Dry Fertilizer Hopper	To put granular fertilizer in the row	SLA8	\$ 580.00

Additional freight will apply



COMPACT RAISED BED MULCH LAYER

EQUIPMENT

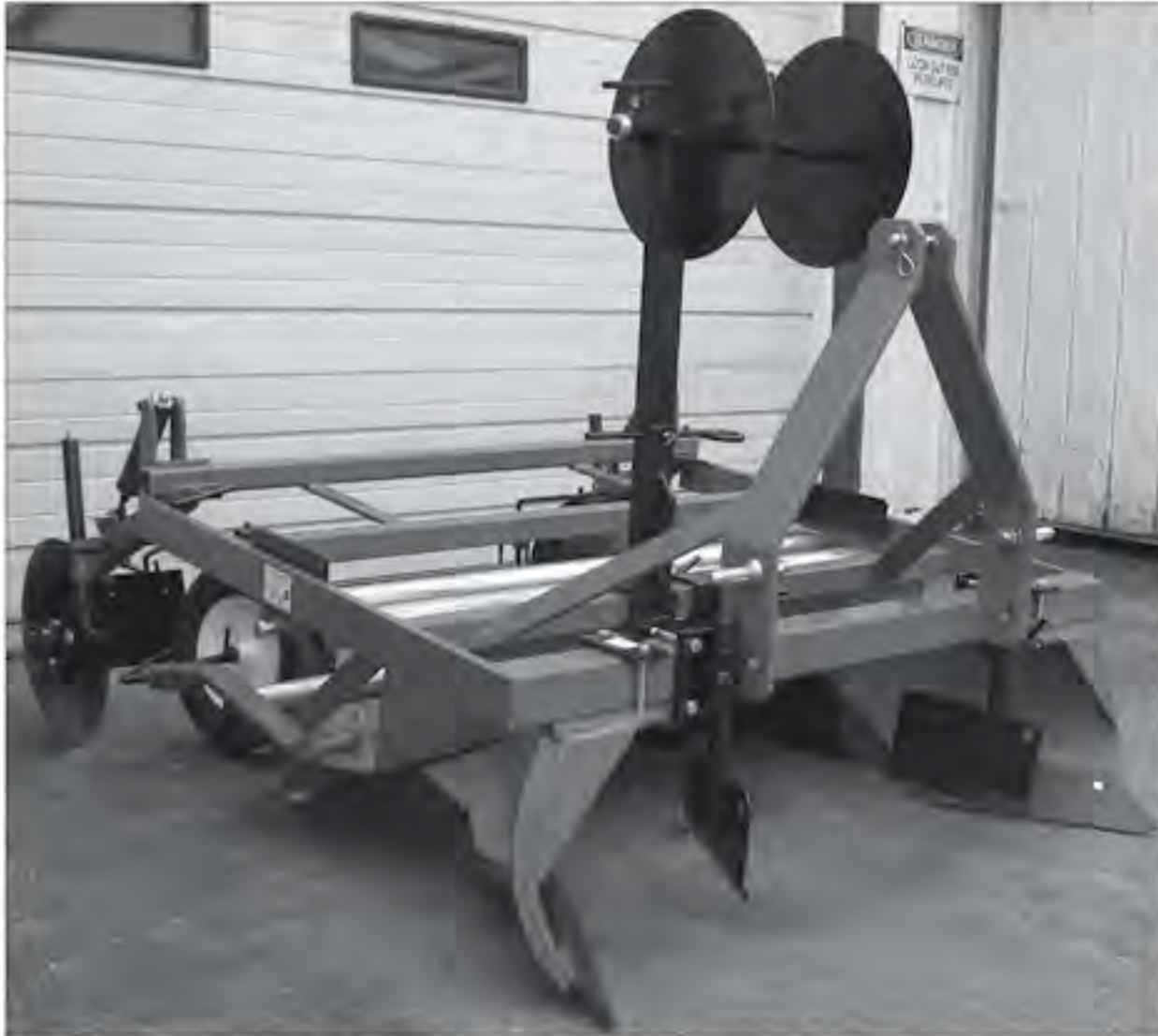

RB448 with Drip Attachment



Spring loaded covering disks



With Double Drip

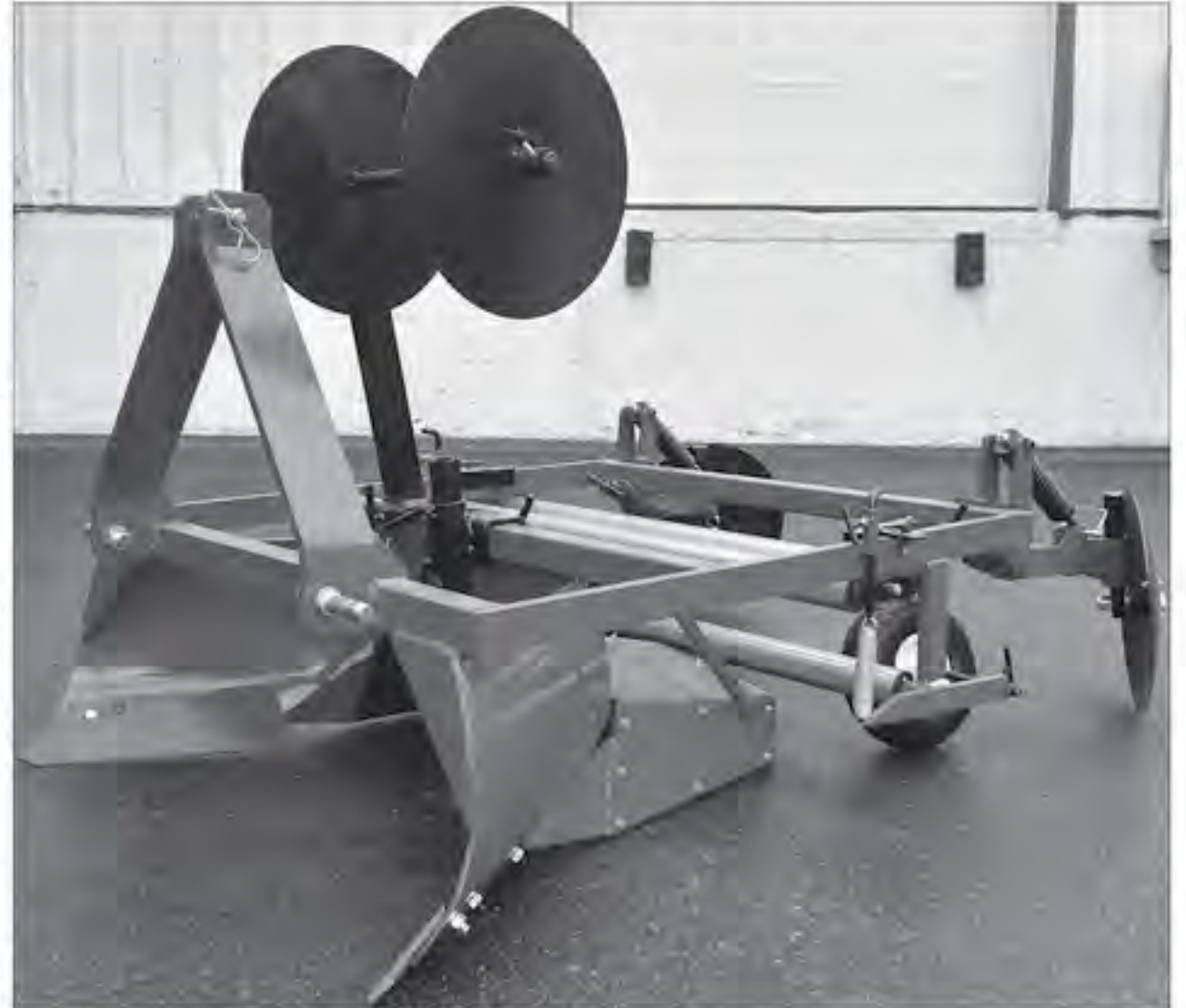

RB436 with Drip Attachment

Designed for use with compact tractors in high tunnels and fields where close spacings are desirable.

Features: Crowned bed is higher in center. Teflon lined bed press gives a smooth, pressed seed bed and eliminates pot holes.

Adjustable tension on plastic roll and independent spring loaded press wheels ensure plastic is stretched tightly.

Large cover disks are independently spring loaded and are fully adjustable to insure that plastic is covered securely.

Drip Irrigation Attachments feature adjustable feed in tube and tension adjustment. Flat free/foam filled press wheels.

11649 Adjustable to lay 3 or 4 ft. wide plastic, Forms 4" high x 20 or 30" wide bed, 30-60hp recommended \$2184.00

12256 Drip Irrigation Attachment for RB448 \$178.95 11650 Double Drip Irrigation Attachment for RB448 \$312.00

14192 Adjustable Row Markers for RB448 or RB436 \$169.95

3745 Lays 3 ft. wide plastic, Forms 4" high and 20" wide bed, 20-40hp recommended. \$1580.00

12958 Drip Irrigation Attachment for RB436 \$178.95 11650 Double Drip Irrigation Attachment for RB436 \$312.00

Dirt shields standard on RB448, Optional on RB436 **RBA2 \$95.00**

Stainless Steel Dry Fertilizer Hopper

To incorporate granular fertilizers in the soil under 4' wide plastic mulch. Wheel drives off of plastic roll for consistent fertilizer flow.

For granular fertilizer. It will not work with powder.

Approximate 100-120 pounds capacity.

Adjustable flow, to control fertilizer rate.

(Fits year 2015 and newer models)

13003 SS Fertilizer Hopper for RB448 \$555.00

RBA5R SS Fertilizer Hopper for RBR440 \$555.00



LIF500S



LIF550S

PLASTIC MULCH LIFTERS

ITEM#	DESCRIPTION	PRICE
LIF500	Model 500 Shear Bolt Protected	\$2,236.00
LIF550S	Model 550 Auto Hydraulic Reset	\$3,265.00
LIF501	Optional Center Vine Cutting Disk	\$185.00

Additional Shipping Charges will Apply

ALUMINUM HARVEST CONVEYOR



Aluminum conveyor designed for harvesting vegetables. Including, but not limited to: melons, sweet corn, pumpkins, broccoli, cabbage and cauliflower. Here are the features that make this conveyor great for the grower that loads directly out of the field:

- * Great for packing bins, boxes or loose on the wagon.
- * Mounts right or left and anywhere from front to rear on a regular farm wagon.
- * Stand is 16" high and sits on one edge of the wagon. Opposite end clamps to wagon with c-clamp attached to a pulley.
- * AHC28 has a 3-1/2' long receiving and grading table. 10" wide picking belt with cleats every foot. Belt travels approximately 50 feet per minute with tractor at idle. It has a bypass valve and plumbing to stop or slow the belt.
- * Bottom belt return track with UHMW strips is standard.
- * Easily put on or taken off.
- * AHC28 includes slow speed high torque hydraulic motor with two 20' long 3/8" hydraulic hoses.
- * Painted aluminum side prevents discoloration of produce upon contact with side.

Optional Equipment:

DROP LID - Removable lide receiving tables allows produce to fall directly into crates, boxes or bins.

ITEM #	OPTIONAL EQUIPMENT DESCRIPTION	PRICE
AHC28/4955	28 ft Aluminum Conveyor with Hydraulic Motor (24' belt), weighs 208 lbs	\$ 2,695.00
AHC50	Optional Drop Lid - Installed	\$125.00
AHC55	Optional Extension Stand - Raises Conveyor from 16" to 30" above wagon	\$145.00
AHC4	Optional hydraulic driver brushes (4-24"). Helps speed cleaning in the field.	\$1,475.00

Jang JP-1 Push Seeder

- Accurately singulates a wide variety of raw and pelletized seeds with quick change seed rollers and easy adjustments
- Over 40 roller sizes available for various planting needs
- Weighs 25 lbs.
- Adjustable handle for height and offset
- Quick release hopper
- Clear plastic hopper to view seed level
- Adjustable depth control
- Hopper volume = 0.26 gal
- Singulates and spaces small seeds; saving time and money
- Seed sizing gauge on hopper lid for ease of roller selection
- No wasted seeds - can work with small amount in hopper



Item #	Description	Price
11619	Jang JP-1 Push Seeder	\$ 495.00
11620	Jang JP-3 Push Seeder	\$1,145.00
11623	Fertilizer Hopper	\$ 230.00



Roller Pricing			
A-6	\$ 21	R-24	\$ 26
AA-6	\$ 21	S-4	\$ 31
BL-12	\$ 21	U-4	\$ 31
C-6	\$ 31	X-4	\$ 21
C-12	\$ 21	X-6	\$ 21
F-6	\$ 21	X-12	\$ 21
F-12	\$ 21	X-24	\$ 26
F-24	\$ 21	XY-4	\$ 31
G-6	\$ 26	XY-12	\$ 31
G-12	\$ 21	XY-24	\$ 31
J-2	\$ 21	XY-36	\$ 41
J-4	\$ 21	XXY-12	\$ 31
J-8	\$ 21	XXY-24	\$ 31
L-12	\$ 21	XXY-36	\$ 41
L-24	\$ 26	Y-4	\$ 21
LI-6	\$ 21	Y-6	\$ 21
LI-12	\$ 21	Y-12	\$ 21
LI-24	\$ 26	Y-24	\$ 26
M-6	\$ 21	YX-4	\$ 21
M-12	\$ 21	YX-6	\$ 21
M-4	\$ 21	YX-12	\$ 21
M-6	\$ 21	YX-24	\$ 26
M-12	\$ 21	YY-6	\$ 21
M-24	\$ 26	YY-12	\$ 21
MM-12	\$ 21	YY-24	\$ 26
MM-24	\$ 26	YYX-12	\$ 21
N-6	\$ 31	YYX-24	\$ 26
Q-6	\$ 21	YYX-26	\$ 31
Q-12	\$ 21	Z-Blank	\$ 21
R-12	\$ 21	Custom	\$ 31

Rollers are not in stock but are available upon request.

Spacing Chart for JP Series Seeders

* Spacing may change due to soil conditions

		Number of Teeth in Each Sprocket									
		14	14	13	13	11	11	11	10	10	9
Rear Sprocket		14	14	13	13	11	11	11	10	10	9
Front Sprocket		9	10	10	11	10	11	13	13	14	14
Number Of Holes In Seed Roller	3 Hole	20	18	17	15	14	13	11	10	9	8
	4 Hole	15	14	13	12	11	10	8	7.5	7	6
	6 Hole	10	9	8	7.5	7	6.5	5.5	5	4.5	4
	12 Hole	5	4.8	5	4	3.5	3	2.8	2.5	2.5	2
24 Hole		2.5	2.5	2	2	1.8	1.5	1.3	1	1	0.5

* Shaded area shows inches between seeds

Seed Name / Seed of Comparable Size:	Recommended Roller	Seed Name / Seed of Comparable Size:	Recommended Roller	Roller	Hole Size	
					mm	Inches
Arugula	YX	Lettuce (Raw)	XY	A	13.5	17/32
Basil	YYJ	Mache	F	AA	12	15/32
Bean-Green	N	Mustard	YYJ	B	10	25/64
Beet	LJ	Okra	LJ	C	11	16-Jul
Broccoli	Y	Onion (Coated)	MJ	R	9	23/64
Cabbage	Y	Onion (Raw)	X	G	9	23/64
Carrot	Y	Pea	BL	Q	8	5/16
Carrot (coated)	MJ	Pepper	MJ	LJ	7.5	19/64
Cauliflower	Y	Radish	X	LJ	7	17/64
Cilantro	MJ	Rutabaga	Y	LJ	7	17/64
Chia	YYJ	Sorghum	MJ	MM	6	15/61
Collard	Y	Sorghum (Coated)	LJ	MJ	6	15/64
Corn	A, AA, N	Soy	BL	M	5	13/64
Cotton	C	Spinach	F	F	5	13/64
Cucumber	J	Sunflower	Send Samples	X	4	5/32
Cut Flower	Send Samples	Swiss Chard	LJ	Y	3.5	9/64
Flax	LJ	Tree Seed	Send Samples	YYJ	3	1/8
Kale	X	Turnip	YYJ	YX	2.5	7/64



SUNDOWN BROADCAST SPREADER, 3 POINT HITCH, 350 LB

ITEM	PRICE
4351	\$695.00

Category 1, 540 rpm. Corrosion proof poly hopper, stainless steel spreading disc with 4 steel vanes. Choice of 3 spread patterns, full center, left or right side. Spreading rates from 30-900 lbs per acre. Optional spread width limiter. Features a strong corrosion proof poly hopper. These spinner units have double levers and stainless steel slides which allow for spreading 180° or 90° to the right or left. They are ideal for even spreading fertilizer, seed, salt, and other flow-able materials. 350 lb. capacity, 5.9 cubic ft., 4.7 bushel capacity, spreading width up to 49'.



SUNDOWN BROADCAST SPREADER, 3 POINT HITCH, 650 LB

ITEM NO.	PRICE
4352	\$769.85

Category 1, 540 rpm. Corrosion proof poly hopper, stainless steel spreading disc with 4 steel vanes. Choice of 3 spread patterns, full center, left or right side. Spreading rates from 30-900 lbs per acre. Optional spread width limiter. Features a strong corrosion proof poly hopper. These spinner units have double levers and stainless steel slides which allow for spreading 180° or 90° to the right or left. Ideal for spreading fertilizer, seed, salt, and other flow-able materials. 650 lb. capacity, 10.4 cubic ft., 8.3 bushel capacity, up to 49' spreading width.

PRICES ON ABOVE SUNDOWN SPREADERS ARE ASSEMBLED AND DELIVERED WITHIN OUR DELIVERY AREA.

SUNDOWN DISK HARROWS



MODEL #	SIZE	ITEM#	DESCRIPTION	PRICE
16-12-GSBC-RS	4 1/2'	1550	Angle Frame, 16" Blade diameter, 12 blades, 20 HP required, 400 lbs.	\$1,550.00
16-16-GSBC-RS	5 1/2'	1785	Angle Frame, 16" Blade diameter, 16 blades, 25 HP required, 460 lbs.	\$1,785.00
18-16-GSBC-RS	5 1/2'	2035	Angle Frame, 18" Blade diameter, 16 blades, 25 HP required, 500 lbs.	\$2,035.00
16-20-GSBC-RS	6 1/2'	2035	Angle Frame, 16" Blade diameter, 20 blades, 30 HP required, 540 lbs.	\$2,035.00
18-20-GSBC-RS	6 1/2'	2225	Angle Frame, 18" Blade diameter, 20 blades, 30 HP required, 560 lbs.	\$2,225.00
DH300-60C	5'	3190	Box Frame, 18" Blade diameter, 16 blades, 30 HP required, 735 lbs.	\$3,190.00
DH300-72C	6'	3465	Box Frame, 18" Blade diameter, 20 blades, 35 HP required, 735 lbs.	\$3,465.00
DH300-84C	7'	3858	Box Frame, 18" Blade diameter, 24 blades, 40 HP required, 900 lbs.	\$3,855.00
DH399-96C	8'	4360	Box Frame, 18" Blade diameter, 28 blades, 45 HP required, 985 lbs.	\$4,360.00

SUNDOWN BOX BLADES



MODEL #	SIZE	ITEM#	DESCRIPTION	PRICE
BB200-48	48"	1220	Box Blade - 4 Shanks - Standard Duty	\$1,220.00
BB200-60	60"	1420	Box Blade - 5 Shanks - Standard Duty	\$1,420.00
BB200-72	72"	11595	Box Blade - 6 Shanks - Standard Duty	\$1,595.00
BB200-84	84"	1750	Box Blade - 6 Shanks - Standard Duty	\$1,750.00
BB300-96	96"	2400	Box Blade - 8 Shanks - Medium Duty	\$2,400.00

SUNDOWN FLAIL MOWERS



MODEL #	SIZE	DESCRIPTION	PRICE
FM-100	39"	30-60 HP, 24 knives, 12 hammers, 660 lbs.	\$2,800.00
FM-130	51"	30-60 HP, 32 knives, 16 hammers, 806 lbs.	\$3,600.00
FM-145	57"	30-60 HP, 36 knives, 18 hammers, 854 lbs.	\$3,850.00
FM-160	63"	35-60 HP, 40 knives, 20 hammers, 907 lbs.	\$3,950.00
FM-175	69"	40-60 HP, 44 knives, 22 hammers, 955 lbs.	\$4,200.00
FM-205	80"	45-60 HP, 52 knives, 26 hammers, 1060 lbs.	\$4,450.00
FM-220	87"	50-60 HP, 56 knives, 28 hammers, 1113 lbs.	\$4,790.00
TBD	TBD	Optional manual side shift jack.	\$45.00

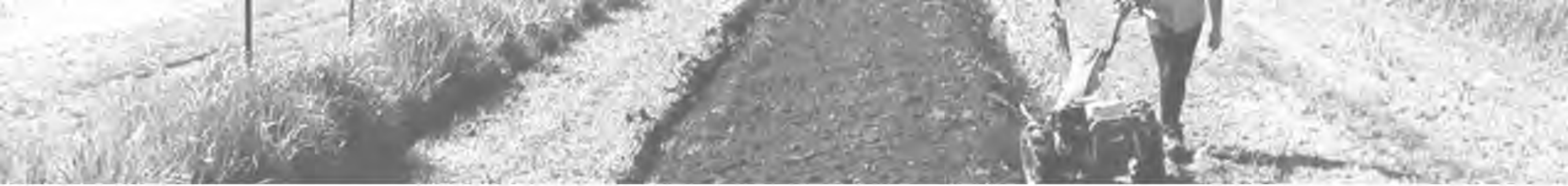

SUNDOWN ROTARY TILLERS



MODEL #	SIZE	DESCRIPTION	PRICE
UL-36	36"	15-40 HP, 24 tines, 540 RPM, 6.5" Tilling Depth, 337 lbs.	\$2,335.00
UL-42	42"	20-40 HP, 30 tines, 540 RPM, 6.5" Tilling Depth, 368 lbs.	\$2,450.00
UL-48	48"	20-40 HP, 36 tines, 540 RPM, 6.5" Tilling Depth, 399 lbs.	\$2,490.00
UL-60	60"	25-40 HP, 42 tines, 540 RPM, 6.5" Tilling Depth, 441 lbs.	\$2,790.00
UM-60	65"	35-50 HP, 48 tines, 540 RPM, 7" Tilling Depth, 627 lbs.	\$3,190.00
UM-72	72"	35-50 HP, 54 tines, 540 RPM, 7" Tilling Depth, 683 lbs.	\$3,290.00
UH-60	65"	40-65 HP, 42 tines, 540 RPM, 7.5" Tilling Depth, 860 lbs.	\$3,550.00
UH-72	72"	45-65 HP, 48 tines, 540 RPM, 7.5" Tilling Depth, 926 lbs.	\$3,800.00
UH-84	84"	50-65 HP, 54 tines, 540 RPM, 7.5" Tilling Depth, 990 lbs.	\$4,100.00
		VH Equipped with multi speed gearbox (below)	
VH-60	60"	50-95 HP, 36 tines, 540 RPM, 9" Tilling Depth, 1280 lbs. <i>VH-60 requires 12 flanges</i>	\$4,600.00
VH-70	70"	60-95 HP, 42 tines, 540 RPM, 9" Tilling Depth, 1370 lbs. <i>VH-70 requires 14 flanges</i>	\$4,900.00
VH-80	80"	70-98 HP, 48 tines, 540 RPM, 9" Tilling Depth, 1464 lbs. <i>VH-80 requires 16 flanges</i>	\$5,250.00
VH-90	89"	80-95 HP, 54 tines, 540 RPM, 9" Tilling Depth, 1557 lbs. <i>VH-80 requires 16 flanges</i>	\$5,600.00
FLG-VH		Optional VH Balde Flange Kit for above VH models	\$25.00/each
		UHH equipped with multi speed gearbox (below)	
UHH-100	100"	90-140 HP, 60 tines, 540/1000 RPM, 10" Tilling Depth, 2339 lbs.	\$11,500.00
UHH-120	120"	100-140 HP, 72 tines, 540/1000 RPM, 10" Tilling Depth, 2573 lbs.	\$11,900.00
TBD	TBD	Pair of 14" disc Plow (LH & RH), 136 lbs.	\$550.00

EQUIPMENT

SUNDOWN LANDSCAPE RAKES - STANDARD DUTY



MODEL #	SIZE	DESCRIPTION	PRICE
LR200-60	5'	Landscape Rake, 195 lbs.	\$1,050.00
LR200-72	6'	Landscape Rake, 215 lbs.	\$1,150.00
LR200-84	7'	Landscape Rake, 235 lbs.	\$1,250.00
LR200-96	8'	Landscape Rake, 255 lbs.	\$1,390.00
LR999-01		Gauge Wheel Setup - fits all LR200, 78lbs	\$620.00





EARTHWAY® GARDEN SEEDER

An ideal row crop seeder, the 1001-B is a tool that takes the guesswork out of planting any row crop. Install one of the seed plates that best fits your seed, then adjust the depth of planting on the ground opener, and then set your 30" long row marker for the desired width, then fill the seed hopper with seeds and you're all set to begin.

Six Standard Seed Plates (included with seeder): **ERT10**

Sweet Corn, **ERT12** Peas, **ERT11** Beans, **ERT07** Radish, **ERT08** Carrots and **ERT09** Beets.

Additional Seed Plates: **ERT34** Lima Beans, **ERT35** Popcorn, **ERT39** Broccoli, **ERT37** Lettuce & **ERT33** Cucumber.

Fertilizer attachment for Side Dressing. Easily attaches to all Earthway garden seeders. Applies fertilizer above ground or below to a depth of 2".



ERT001
with ERT45

Item #	Description	Price
1388	Earthway® Garden Seeder, 12 Lbs.	\$124.75
ERT005	Fertilizer Applicator, 3 Lbs.	\$80.00
ERT45	Seed Plate Storage Case, mounts on	\$23.95
13519	Standard Seed Plate, Set of 6	\$35.00
10694	Additional Seed Plate, Set of 5	\$35.00
<i>See desc.</i> Individual Seed Plates, specify when ordering		\$ 7.50



EARTHWAY® HIGH WHEEL CULTIVATOR

The EarthWay® 6500W Kentucky Style High Wheel Cultivator features solid oak handles and a 24" steel wheel.

Three standard tools are included: Five tine cultivator, moldboard plow, and twin end plow.



ERT6500W

11926

Item #	Description	Price
ERT6500W	Earthway® High Wheel Cultivator	\$134.95
11926	Optional Weed Slicing Hoe, 2 Lb.	\$ 48.65



EARTHWAY® SEEDER SPREADER

- 20 Lb. Hopper capacity– zippered top, rustproof nylon construction
- Contoured molded base
- Adjustable shoulder strap
- Rocking agitator
- Spring loaded rate adjustment/shut-off



Item #	Description	Price
800	Earthway® Seeder/Spreader	\$48.95

Item #	Description	Price
13143	Hand Planter 8LBS.	\$83.00



This 8 LB. planter allows you to plant directly through plastic. Simply drop the seed into the tube, insert planter through plastic, tilt planter forward to release the seed.

Item #	Description	Price
CS001	Champion Seeder	\$785.65

CHAMPION SEEDER

Designed to direct seed beans into plastic mulch. May also work for some other crops. 6" spacing with the option of removing every other spike for 12" spacing.

Has Earthway hopper with 6 standard seed plates. See Earthway Seeder description.



A freight charge may apply to the prices listed above.

SOLO 475 BACKPACK SPRAYER 4 GALLON DIAPHRAGM



ITEM NO.	PRICE
13783	\$98.95

High-density polyethylene tank with ultra-violet inhibitors allows for unmatched durability and ultra-violet protection. Features a large 4.25" opening with filter basket. Shut-off valve and wand overall length of 28" for hard-to-reach places. 4' of high-pressure hose. Padded shoulder straps for greater comfort. The model 475 is capable of producing up to 60 psi, with its rugged connecting rod actuated diaphragm pump. The diaphragm is made of high-quality Viton for its resistance to harsh chemicals and abrasion and its long life expectancy. By design the diaphragm is able to pass small abrasive particles without damage to the pump assembly. The diaphragm pump is ideal for handling chemicals in wet table powder form, as well as liquid formulations.

SOLO 425 BACKPACK SPRAYER, 4 GAL PISTON



ITEM NO.	PRICE
123	\$95.99

High-performance piston pump for increased pressure capabilities. Extra large (4.25in) opening for easier filling & cleaning. 28" unbreakable wand & shut off valve. 48in high-pressure hose. Padded shoulder straps.

SOLO 433 5 GALLON, GAS POWERED, SPRAYER



ITEM NO.	PRICE
12392	\$649.50

Gas powered 5 gallon motorized sprayer. The 435 psi capacity of this sprayer allows for fine mist application at a minimum flow rate of 0.5 gpm.

SOLO 430 HANDHELD SPRAYER



ITEM NO.	CAPACITY	PRICE
4151	1 Gallon	\$37.99
5051	2 Gallon	\$33.95
3901	3 Gallon	\$44.99

Designed for general purpose spraying. Viton seals, long hose, large pump handle and funnel top for easy filling. Includes an assortment of four nozzles. Adjustable for spraying a steam to a mist; Flat Fan for area and row application; Hollow Cone for shrubs and bushes; and Jet Stream for additional reach.

SOLO 466 3.7 GALLON, GAS POWERED, MIST BLOWER



ITEM NO.	PRICE
1918	\$639.95

Gas powered 3 gallon motorized mist blower. 66.5 cc engine with nickel/silicone carbide cylinder coating to generate a fan air volume of max 824 CFMs for total operating conditions.

WE CARRY AN EXTENSIVE SUPPLY OF SOLO SPRAYERS AND REPLACEMENT PARTS. PLEASE INQUIRE AND WE WILL ASSIST YOU IN FINDING THE RIGHT PRODUCT.

Battery Operated 12V Sprayers

All Units Feature: 12V Shurflo pump set at 100 PSI. 15' Hose with spray gun. Angled swivel nozzle, stream to mist. Connected wire leads with fused switch.

Spray Caddy: Battery-powered unit on 10" wheels. Includes 12V battery and regulated charger that prevents overcharging the battery. A convenient six gallon container that lifts out to fill and clean. Sprays approx. 18 gal / charge.

Portable Sprayers: Yellow tank (15 or 25 gal.), same components as spray caddy. Connects to 12 Volt battery. Ideal to mount on a garden cart, ATV, etc.

Item #	Description	Price
13739	Spray Caddy, 6 gal. tank	\$379.95
1477	Portable Sprayer, 15 gal. tank	\$249.95
4387	Portable Sprayer, 25 gal. tank	\$329.95



GREENHOUSE SUPPLY

DRAMM® MINI AUTO FOG™

The Damm Mini AutoFog is an easy to use, low volume chemical applicator designed with smaller greenhouses in mind. It can treat 5,000 sq. ft. automatically without an operator present. It can easily apply a wide variety of chemical formulations using a highly concentrated spray solution. A specially designed nozzle generates billions of micro-particles (0.05 - 10.0 microns) that fill the entire treatment area with active chemical. These tiny particles ensure complete and even coverage of all plant surfaces. This "low-volume" method of applying chemical solutions eliminates costly run-off and reduces the amount of chemical needed. 24 Hour timer, starts and stops automatically. Durable oilless compressor for even supply of air. 60 rpm mechanical agitation—keeps chemicals in suspension.

Standard Treatment Area: Up to 5,000 sq. Ft. (7,000 sq ft with circulation fans)

Nozzle: Air atomizing, outputs 8 liters in 4 hours.

Adjustable Nozzle Height: 5-7 ft.

Tank size: 8 Liters (8.45 quarts)

Item #	Description	Price
DFA10	110 Volt Mini AutoFog™	\$4,115.00



DRAMM® K-10 PORTABLE PULSFOG®

The PulsFOG thermal fogger is perfect for the rapid application of greenhouse chemicals. Designed to expel chemicals at great distances and speed, reduces application time and ensures even coverage of all surfaces with a highly dense, visible fog.

Perfect for the application of insecticides, fungicides, and disinfectants.

Propels chemical: 45 ft with NutriFog, 100 ft with VK-1 (more with the help of circulation fans)

Item #	Description	Price
DFP10	25 Hp 2.6 gallon Thermo Fogger	\$3,275.45



PULSFOG® DILUENT SOLUTIONS: For best results, the PulsFOG requires the use of carrier solutions-or fog enhancer's. These solutions help to create more even particle size, distribute the solution throughout the area, and retard evaporation of fog droplets. Some chemicals may not require additional carrier solutions due to their formulation. Check with your chemical supplier for more in-depth information.

NUTRIFOG

This carrier is a 10-3-3 Foliar Fertilizer. It can be used with all chemical formulations. It is safe on ornamentals, fruits & vegetables.

Do not use more than five times in one month on the same crop.

Rates for NutriFOG:

- 0.25 Quart NutriFOG Solution
- 1.75 Quarts Water
- Apply above mix into 10,000 square feet of area

Item #	Description	Price
DFPNF	NutriFog, 5 gallon pail	\$ 429.75

GREENHOUSE BENCHES AND COMPONENTS



Heavy-duty galvanized square tubing frame with reinforced smooth corners, SS fasteners and A-V plastic bench tops makes this bench exceptionally durable. Sizes are 4' by 8', 10', 12', 14'. Custom sizes can be special ordered as well. Leg Kits and other components are available.

DISPLAY RACKS, TRANSPORT CARTS, NURSERY CART AND GREENHOUSE SHOPPING CARTS
ALL TYPES OF CARTS AND RACKS TO HELP STREAMLINE YOUR GREENHOUSE. CALL FOR MORE DETAILS.



PC Anti Drain Drippers

These can be punched into orchard tubing and are used in vineyards, orchards, as well as nurseries and greenhouses. Anti-drain and pressure compensating.

Operating Pressure: 15-60 PSI.



Item #	Description	Price	500+
12478	Blue, 0.5 GPH w/Nipple for Spiders	\$0.26	\$0.23
10679	Gray, 1.0 GPH w/Nipple for Spiders	\$0.26	\$0.23
11846	Red, 2.1 GPH w/Nipple for Spiders	\$0.26	\$0.23
13547	WPJC Netafim Red, 0.5 GPH w/Barb	\$0.33	\$0.30
14717	WPJC Netafim Grey, 1.0 GPH w/Barb	\$0.33	\$0.30

White Spider Assemblies

Multi-outlet device for PCD drippers.

These four outlet assemblies are commonly used for mums and other potted plants. They have straight stakes which allows for easy removal from established plants. Use with above PCD drippers.



Item #	Description	Pack of 10	Case of 100
12479	Spider, 4x 18" tubes	\$ 10.50	\$100.00
12480	Spider, 4 x 24" tubes	\$11.50	\$110.00
12482	Spider, 4 x 36" tubes	\$12.50	\$120.00

Spider Components

Make your spiders to water anywhere from 1 to 6 pots per dripper using 1/8" spaghetti tubing (below).



Tees, crosses, and adapters can be combined.

Item #	Description	1-99	100+
12897	Single Outlet Adapter	\$0.11	\$0.12
12899	Two Outlet Tee	\$0.11	\$0.10
14718	Two outlet cross	\$0.13	\$0.12
12759	Two outlet cross	\$0.20	\$0.19
14719	Dripper Stake, Straight	\$0.13	\$0.12

Spaghetti Tubing

Item #	Description	Dimensions	Price
12837	Black 1/8" x 100'	0.187 OD x 0.118" ID	\$ 7.29
12833	Black 1/8" x 1000'	0.196"OD x 0.126" ID	\$39.00
14008	Black 3/16" x 100'	0.250 OD x 0.170" ID	\$ 7.95
10398	Black 3/16" x 1000'	0.196"OD x 0.126" ID	\$58.00

Barb to Barb Couplings

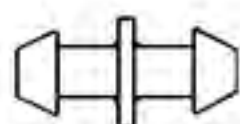

Item #	Description	1-99	100+
12835	1/8" Barb Couplings	\$0.11	\$0.09
14720	3/16" Barb Couplings	\$0.11	\$0.09

Netafim™ Pot Drippers



SlimLine EZ Close Assemblies combines the benefits of:

- One-hand, EZ close shut-off of individual baskets – prevents water and fertilizer spillage and waste
- Snag-free slim design for easy retrieval from plants at harvest – no more lost weights
- 94% flow uniformity – from the first basket to the last

For 1 gph or custom length:

Assemble your own using NDT00 weight, NDT00121 tubing and NDT005 or

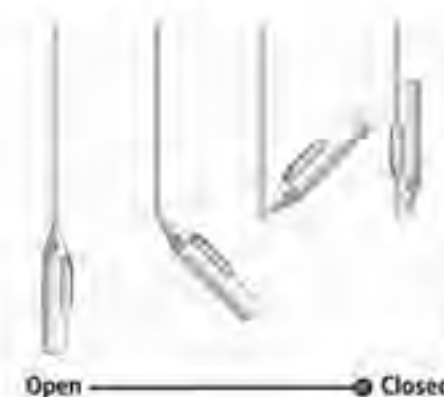

Item #	Description	25-475	500+
13466	Pot Dripper, 24" tube, 1/2 gph	\$ 0.89	\$ 0.85
12910	Pot Dripper, 36" tube, 1/2 gph	\$ 0.95	\$ 0.85
4510	Pot Dripper, 48" tube, 1/2 gph	\$ 1.20	\$ 1.15
13540	Slimline Plastic Weight/Shutoff	\$ 0.47	\$ 0.44

JAIN On/Off Twist Weights

These plastic on/off twist weights come with 0.060" ID tubing. Not pressure compensating, used for fast watering. Max of 50' row lengths when using 1/2" supply line.



Item #	Description	Price
13086	On/Off Twist Weight, 24" tube	\$ 1.25
14721	On/Off Twist Weight, 36" tube	\$ 1.30
14722	On/Off Twist Weight, 48" tube	\$ 1.40

Pressure Compensating, 0.5 GPH

Micro Flappers® elbow. You can put these on above Jain drippers to make them pressure compensating. To do that you'll need 1.5" length of BVT0012 0.118" ID tubing each. Uniform flow regardless of pressure, elevation and length of supply line. Operating Pressure: 15-45 PSI.

Item #	Description	1-99	100+
14723	0.5 GPH Emitter, 90° E11	\$0.49	\$0.45

Pot Spray Stakes

Provides consistent flow and 160° spray pattern.

Unique positioning arrow for indicator of flow.

Use 1/8" or 3/16" couplings & spaghetti tubing.



Item #	Description	1-99	100+
13813	Pot Spray Stake, 6.4 GPH, Black	\$0.21	\$0.19
14724	Pot Spray Stake, 10.5 GPH, Blue	\$0.21	\$0.19
12908	Pot Spray Stake, 16.0 GPH, Green	\$0.21	\$0.19

Goof Plugs

Plugs holes 1/8" – 1/4" in diameter in poly tubing.



Item #	Description	Price
5158	Goof Plugs. Pack of 10	\$0.50

NaanDan Jain® Modular Group

Performance Micro-Sprinklers and Sprayers









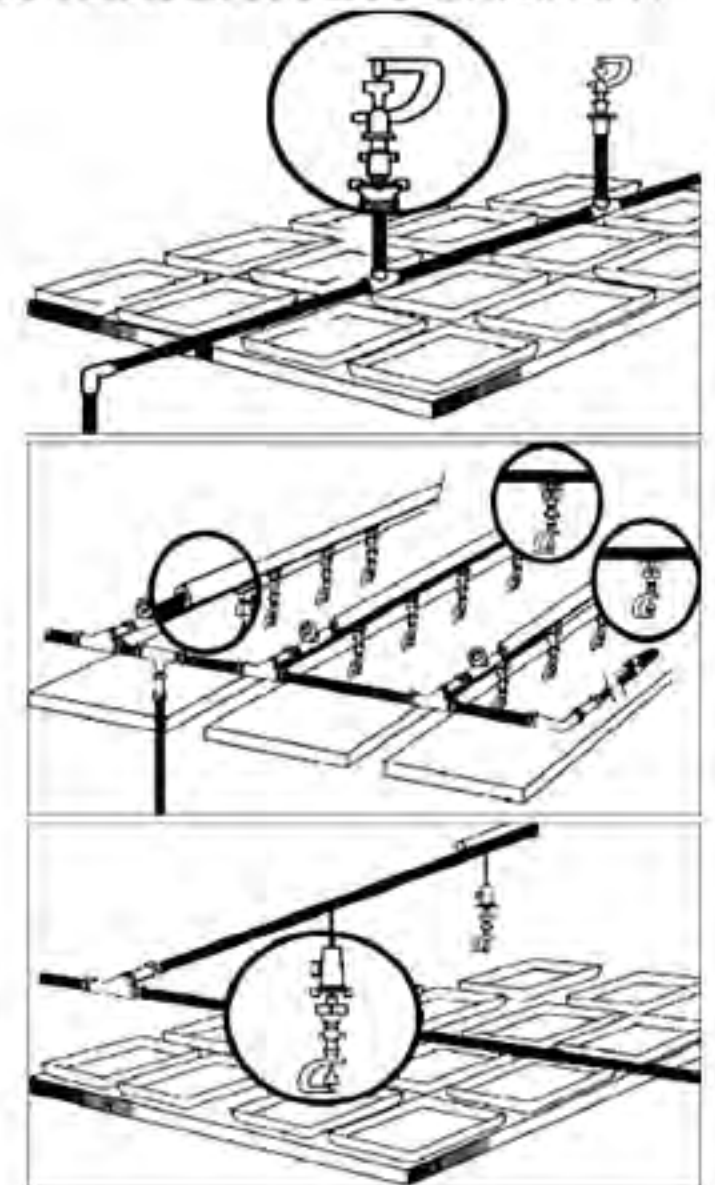



Sprinkler Selection Chart • All sprinklers calculated at 3' spacing.

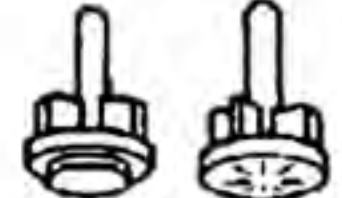
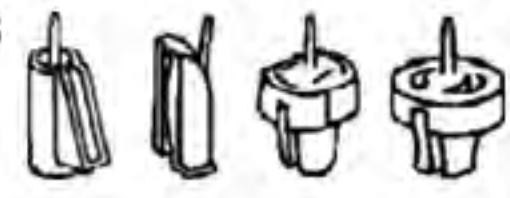

Spreader or Spinner	Flow Rate	Height	Bench or Bed Width													
			4'	5'	6'	7'	8'	10'	12'	14'	15'	16'	18'	20'	22'	24'
Yellow Flat	Low	2'	G	O	O	O	-	-	-	-	-	-	-	-	-	-
		4'	-	-	O	O	O	-	-	-	-	-	-	-	-	-
	High	2'	Y	Y	Y	B	-	-	-	-	-	-	-	-	-	-
		4'	-	-	B	B	-	-	-	-	-	-	-	-	-	-
Green Kiwi	Low	4'	-	-	-	-	-	-	O	O	O	O	G	-	-	
		6'	-	-	-	-	-	-	O	O	O	O	O	O	-	
	High	4'	-	-	-	-	-	-	B	B	B	B	-	-	-	
		6'	-	-	-	-	-	-	B	B	B	B	B	-	-	
Black Round	Low	4'	-	-	-	-	-	O	O	-	-	-	-	-	-	
		6'	-	-	-	-	G	O	O	-	-	-	-	-	-	
	High	4'	-	-	-	-	Y	Y	Y	-	-	-	-	-	-	
		6'	-	-	-	-	Y	Y	Y	Y	-	-	-	-	-	
Black Single Wing	Low	10"	-	-	-	-	-	O	O	O	O	-	-	-	-	
	High	10"	-	-	-	-	-	B	B	B	B	-	-	-	-	
Orange Oblong	Low	10"	-	-	-	-	-	-	-	-	-	Gy	Gy	Gy	G	
	High	10"	-	-	-	-	-	-	-	-	-	-	O	O	O	

Notes: •10" Height is based on upright sprinkler setup.
 •24", 48", & 72" are based on inverted (hanging) setups.
 •Nozzle Color Codes: G=Green O=Orange Y=Yellow B=Blue Gy=Gray



Greenhouse Hanging Assembly Includes: • Nozzle, • Spinner, • Bridge, • LPD, • Stabilized Hanging Tube  <table border="1"> <thead> <tr> <th>Length</th> <th>Price</th> </tr> </thead> <tbody> <tr> <td>24"</td> <td>\$5.96</td> </tr> <tr> <td>36"</td> <td>\$6.12</td> </tr> <tr> <td>48"</td> <td>\$6.27</td> </tr> </tbody> </table>	Length	Price	24"	\$5.96	36"	\$6.12	48"	\$6.27	Bridge Assembly (Butterfly) Includes: • Nozzle, • Spinner, • Bridge, • Butterfly  <table border="1"> <thead> <tr> <th>Price</th> </tr> </thead> <tbody> <tr> <td>\$2.00</td> </tr> </tbody> </table>	Price	\$2.00	Upright Assembly Includes: • Nozzle, • Spinner, • Bridge, • Stabilized Hanging Tube • 12" Stake  <table border="1"> <thead> <tr> <th>Tube Length</th> <th>Price</th> </tr> </thead> <tbody> <tr> <td>24"</td> <td>\$4.50</td> </tr> <tr> <td>36"</td> <td>\$4.66</td> </tr> <tr> <td>48"</td> <td>\$4.82</td> </tr> </tbody> </table>	Tube Length	Price	24"	\$4.50	36"	\$4.66	48"	\$4.82	Bridge Assembly Includes: • Nozzle, • Spinner, • Bridge  <table border="1"> <thead> <tr> <th>Price</th> </tr> </thead> <tbody> <tr> <td>\$1.44</td> </tr> </tbody> </table>	Price	\$1.44													
Length	Price																																			
24"	\$5.96																																			
36"	\$6.12																																			
48"	\$6.27																																			
Price																																				
\$2.00																																				
Tube Length	Price																																			
24"	\$4.50																																			
36"	\$4.66																																			
48"	\$4.82																																			
Price																																				
\$1.44																																				
Nozzle & Anti-mist Specify Color  <table border="1"> <thead> <tr> <th>Item #</th> <th>Description</th> <th>Price</th> </tr> </thead> <tbody> <tr> <td>NMS0*</td> <td>Nozzle</td> <td>\$0.30</td> </tr> <tr> <td>NMS6*</td> <td>Antimist</td> <td>\$0.39</td> </tr> </tbody> </table>	Item #	Description	Price	NMS0*	Nozzle	\$0.30	NMS6*	Antimist	\$0.39	Spreaders  <table border="1"> <thead> <tr> <th>Item #</th> <th>Size</th> <th>Price</th> </tr> </thead> <tbody> <tr> <td>NMS5*</td> <td>Specify Color</td> <td>\$0.37</td> </tr> </tbody> </table>	Item #	Size	Price	NMS5*	Specify Color	\$0.37	Spinners  <table border="1"> <thead> <tr> <th>Item #</th> <th>Size</th> <th>Price</th> </tr> </thead> <tbody> <tr> <td>NMS4*</td> <td>Specify Color</td> <td>\$0.37</td> </tr> </tbody> </table>	Item #	Size	Price	NMS4*	Specify Color	\$0.37	Bridge  <table border="1"> <thead> <tr> <th>Item #</th> <th>Description</th> <th>Price</th> </tr> </thead> <tbody> <tr> <td>12697</td> <td>Bridge</td> <td>\$0.89</td> </tr> </tbody> </table>	Item #	Description	Price	12697	Bridge	\$0.89						
Item #	Description	Price																																		
NMS0*	Nozzle	\$0.30																																		
NMS6*	Antimist	\$0.39																																		
Item #	Size	Price																																		
NMS5*	Specify Color	\$0.37																																		
Item #	Size	Price																																		
NMS4*	Specify Color	\$0.37																																		
Item #	Description	Price																																		
12697	Bridge	\$0.89																																		
Stabilized Hanging Tubes, (Tube, stabilizer and butterfly mount) Plastic Stakes, 12" (See Upright Assembly for use illustration)  <table border="1"> <thead> <tr> <th>Item #</th> <th>Size</th> <th>Price</th> </tr> </thead> <tbody> <tr> <td>13186</td> <td>24" Tube</td> <td>\$2.25</td> </tr> <tr> <td>15304</td> <td>36" Tube</td> <td>\$2.40</td> </tr> <tr> <td>12697</td> <td>48" Tube</td> <td>\$5.55</td> </tr> <tr> <td>13188</td> <td>12" Stake</td> <td>\$0.89</td> </tr> </tbody> </table>	Item #	Size	Price	13186	24" Tube	\$2.25	15304	36" Tube	\$2.40	12697	48" Tube	\$5.55	13188	12" Stake	\$0.89	Butterfly Mount  <table border="1"> <thead> <tr> <th>Item #</th> <th>Description</th> <th>Price</th> </tr> </thead> <tbody> <tr> <td>NMS33</td> <td>Butterfly Mount</td> <td>\$0.58</td> </tr> </tbody> </table>	Item #	Description	Price	NMS33	Butterfly Mount	\$0.58	1/2" Male Threaded Base  <table border="1"> <thead> <tr> <th>Item #</th> <th>Description</th> <th>Price</th> </tr> </thead> <tbody> <tr> <td>NMS35</td> <td>1/2" Male Base</td> <td>\$1.05</td> </tr> </tbody> </table>	Item #	Description	Price	NMS35	1/2" Male Base	\$1.05	Agri-Connector 1/2" FPT x 3/16" Barb  <table border="1"> <thead> <tr> <th>Item #</th> <th>Description</th> <th>Price</th> </tr> </thead> <tbody> <tr> <td>15307</td> <td>Agri-Connector</td> <td>\$0.95</td> </tr> </tbody> </table>	Item #	Description	Price	15307	Agri-Connector	\$0.95
Item #	Size	Price																																		
13186	24" Tube	\$2.25																																		
15304	36" Tube	\$2.40																																		
12697	48" Tube	\$5.55																																		
13188	12" Stake	\$0.89																																		
Item #	Description	Price																																		
NMS33	Butterfly Mount	\$0.58																																		
Item #	Description	Price																																		
NMS35	1/2" Male Base	\$1.05																																		
Item #	Description	Price																																		
15307	Agri-Connector	\$0.95																																		
LPD (Anti-Drip) Opens at 20 PSI Closes at 9 PSI  <table border="1"> <thead> <tr> <th>Item #</th> <th>Size</th> <th>Price</th> </tr> </thead> <tbody> <tr> <td>12048</td> <td>LPD (Anti-Drain)</td> <td>\$2.35</td> </tr> </tbody> </table>	Item #	Size	Price	12048	LPD (Anti-Drain)	\$2.35	3/16" Barb Connector  <table border="1"> <thead> <tr> <th>Item #</th> <th>Size</th> <th>Price</th> </tr> </thead> <tbody> <tr> <td>14720</td> <td>3/16" Barb</td> <td>\$0.11</td> </tr> </tbody> </table>	Item #	Size	Price	14720	3/16" Barb	\$0.11	3/16" Black Vinyl Tubing To make custom length tubes. <table border="1"> <thead> <tr> <th>Item #</th> <th>Description</th> <th>Price</th> </tr> </thead> <tbody> <tr> <td>14008</td> <td>3/16" x 100'</td> <td>\$ 7.95</td> </tr> <tr> <td>10398</td> <td>3/16" x 1000'</td> <td>\$58.00</td> </tr> </tbody> </table>	Item #	Description	Price	14008	3/16" x 100'	\$ 7.95	10398	3/16" x 1000'	\$58.00													
Item #	Size	Price																																		
12048	LPD (Anti-Drain)	\$2.35																																		
Item #	Size	Price																																		
14720	3/16" Barb	\$0.11																																		
Item #	Description	Price																																		
14008	3/16" x 100'	\$ 7.95																																		
10398	3/16" x 1000'	\$58.00																																		

NaanDan Jain® Foggers/Misters

Performance Micro-Sprinklers and Sprayers

Commonly used for propagation, cooling and humidification in greenhouses. Contact us for design information. **Recommended Pressure: 35 – 45 PSI.** For mounting/hanging options see Modular Group Sprinklers/Sprayers on page 33.



Installation Recommendations:

One fogger should be used for every 2.5 square feet. The cross with four foggers will cover an area up to 10 square feet (3 – 4 feet wide).

Foggers should be installed at a height of 3 – 5 feet above the propagation material.

The spacing between the fogger assemblies should be 3 feet.

Multiple flow rates available for different precipitation rates.

3' – 4' Bench: One line above the center.

6' – 7' Bench: Two lines with crosses are required.

To prevent dry edges on a single bench (no other benches within 2') the cross should not be further than 1' from the edge. In some instances two lines may be required on a 4' bench.

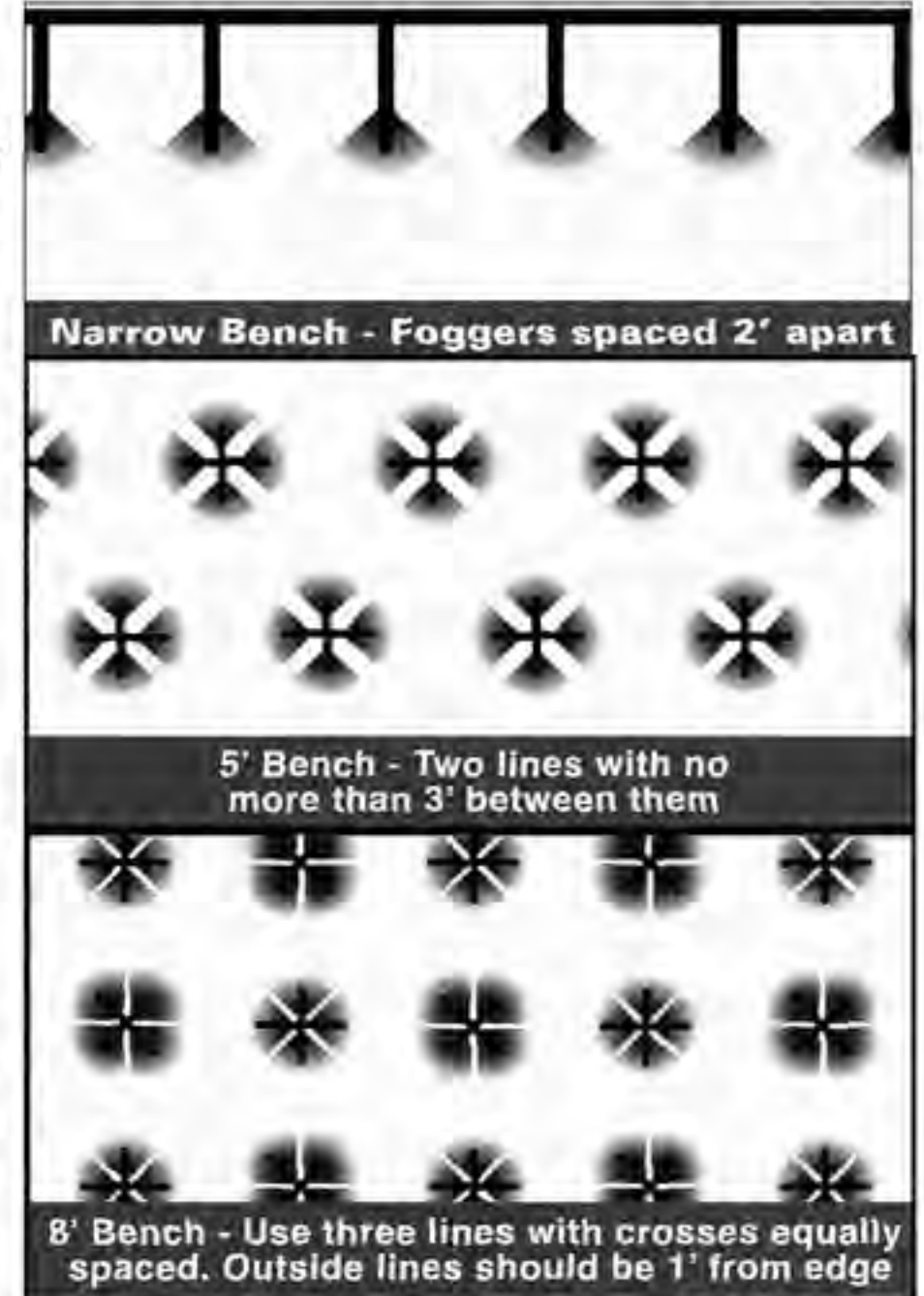

Item #	Description	Price
13057	Blue Fogger, 1.8 GPH	\$1.80
13058	Orange Fogger, 3.6 GPH	\$1.80
13059	Red Fogger, 5.4 GPH	\$1.80
13060	Black Foggers, 7.2 GPH	\$1.80
12921	LPD (Anti-Drip), Opens at 55 PSI, Closes 35 PSI	\$2.29
12922	4 Way Cross	\$1.98
14725	2 Way Tee	\$1.89
14726	45° Angle Adapter	\$0.75
14727	Plug	\$0.39

Senninger® Mini-Wobblers

Low-angle trajectory & good droplet size reduce wind drift and distortion of the spray pattern.

Space & stagger these sprinklers at 30% less than listed diameter for uniform coverage.



mini-Wobbler, Upright

Diameter calculated at 1.5' height.

Nozzle Color	Light Blue		Beige		Gold		Lime		Lavender	
	#4	1/16"	#5	5/64"	#6	3/32"	#7	7/64"	#8	1/8"
Nozzle PSI	GPM	DIA.	GPM	DIA.	GPM	DIA.	GPM	DIA.	GPM	DIA.
15	0.42	26.5	0.64	31.0	0.95	33.0	1.30	35.0	1.67	35.5
20	0.50	28.0	0.75	33.5	1.10	36.0	1.51	37.5	1.95	38.5
25	0.56	28.0	0.84	35.0	1.25	37.0	1.69	38.5	2.18	43.0

i-mini-Wobbler, Inverted

Diameter calculated at 6' height.

Nozzle Color	Beige		Gold	
	#5	5/64"	#6	3/32"
Nozzle PSI	GPM	DIA.	GPM	DIA.
20	0.75	32.0	1.10	34.0
25	0.84	32.5	1.25	34.5

Riser Assembly 1/2" FPT x barb. Use DTFAP07 punch. Use 1/2" or 3/4" pipe or 5/16" rod for stake.

Item #	Description	Price
13173	W/36" tube	\$3.85
14202	W/48" tube	\$3.95

Operating Pressures: 15-25 PSI (Upright); 20-25 PSI (Inverted).
Connections: 1/2" MPT.

Item #	Description	Price
Upright mini-Wobbler®		
13127	Upright mini-Wobbler, #4 Blue Nozzle	\$4.10
13128	Upright mini-Wobbler, #5 Beige Nozzle	\$4.10
13129	Upright mini-Wobbler, #6 Gold Nozzle	\$4.10
13130	Upright mini-Wobbler, #7 Lime Nozzle	\$4.10
13132	Upright mini-Wobbler, #8 Lavender Nozzle	\$4.10

Inverted mini-Wobbler®:

14728	Inverted mini-Wobbler, #5 Beige Nozzle	\$4.10
13465	Inverted mini-Wobbler, #6 Gold Nozzle	\$4.10

Replacement Nozzles:

14729	#4 Blue Nozzle for mini-Wobbler	\$0.79
14730	#5 Beige Nozzle for mini-Wobbler	\$0.79
14731	#6 Gold Nozzle for mini-Wobbler	\$0.79
14732	#7 Lime Nozzle for mini-Wobbler	\$0.79
14044	#8 Lavender Nozzle for mini-Wobbler	\$0.79

Senninger® Xcel-Wobblers

The Xcel-Wobbler uses Senninger's off-center rotary-action technology. It provides an extremely uniform and instantaneous application pattern over a large area at lower pressures, and with very low evaporative loss and wind drift. Wobblers are designed for nursery irrigation and frost protection. Wobblers installed in test bed withstood winds up to 25 MPH and temperatures as low as 18°. They are an excellent sprinkler for small diameters from 35 to 56 feet. The Xcel has less vibration than earlier models. **Connection:** 1/2" MPT.

Operating Pressures: 10 – 25 PSI.

Space & stagger these sprinklers at 30% less than listed dia. for uniform coverage.



Diameter at 1.5' height.

Nozzle Color	Gold		Lavender		Turquoise		Red		Blue		Orange	
	#6	3/32"	#8	1/8"	#10	5/32"	#12	3/16"	#14	7/32"	#16	1/4"
Nozzle PSI	GPM	DIA.	GPM	DIA.	GPM	DIA.	GPM	DIA.	GPM	DIA.	GPM	DIA.
10	0.78	36.5	1.40	42.0	2.22	44.5	3.23	46.0	4.40	47.0	5.61	48.0
15	0.95	41.0	1.71	46.5	2.72	49.0	3.96	50.5	5.39	51.0	7.88	52.5
20	1.10	45.0	1.98	47.0	3.14	50.5	4.57	52.0	6.23	53.0	9.63	55.0
25	1.23	46.0	2.21	51.5	3.51	53.5	5.11	54.5	6.97	55.5	11.01	56.5

Item #	Description	Price
4850	Xcel-Wobbler, #6 Gold Nozzle	\$7.55
4962	Xcel-Wobbler, #8 Lavender Nozzle	\$7.55
13170	Xcel-Wobbler, #10 Turquoise Nozzle	\$7.55
14012	Xcel-Wobbler, #12 Red Nozzle	\$7.55

Replacement Nozzle:

14733	#6 Gold Nozzle for Xcel-Wobbler	\$0.85
14734	#8 Lavender Nozzle for Xcel-Wobbler	\$0.85
4963	#10 Turquoise Nozzle for Xcel-Wobbler	\$0.85
4964	#12 Red Nozzle for Xcel-Wobbler	\$0.85
14735	#14 Blue Nozzle for Xcel-Wobbler	\$0.85
12024	#16 Orange Nozzle for Xcel-Wobbler	\$0.85
15308	#7 Lime Nozzle for xcel Nobbler	\$0.85



KOOL RAY CLASSIC SHADE, 1 GALLON

Concentrated liquid shade. Common dilution rate is 1 part to 8 parts water, which reduces light transmission 31%. 1:3 ration reduces light 45%. 1:1 ratio reduces light 65%. One gallon of solution covers 175 sq. ft. Can be applied by brush, roller or spray, but works best when spray applied. Usually applied in spring or summer then during the course of the year, the shading will slowly wear off for increased light levels as the daylight increases. Frost will also loosen shade. Keep product from freezing.



ITEM	DESCRIPTION	PRICE	QTY. PRICE
10871	Kool Ray, Liquid Shade	\$ 35.50	(+40) \$34.50

Black Knitted Shade Cloth, 50% Shade



In Stock. Made from 100% UV stabilized polyethylene with a lock stitch construction that keeps edges from unraveling.

The material to be cut to exact size on job site with household scissors. "Clip-its" to hold material are supplied at no extra charge, enough for 4' spacing on length of both sides. *Shipping Weight: 40 lbs/100'.*

Item #	Description	1 - 94'	95'+
12303	26' Shade Cloth, 50% Black Knitted	\$4.25	\$3.85
12487	34' Shade Cloth, 50% Black Knitted	\$5.20	\$4.79
4277	Plastic Clip-its (folds & clamps to secure)	\$0.29	-

If you don't see something in our catalog, please call us.

Custom sizes and other shade percentages are also available. Allow two weeks for delivery on custom orders. Call us for pricing. Available shade



Tufflite® Greenhouse Plastic

Manufactured by Berry Plastics, Tufflite™ products offer high clarity to allow the most light possible. They also feature tri-layer extrusion and dust resistance.



Tufflite IV™ is a high clarity, 4 year, 6 mil, high-quality greenhouse covering.

Tufflite IV™, Clear, 6 mil, 4 year					
Item #	Size	Price	Item #	Size	Price
3464	14' x 100'	\$149.75			
3187	20' x 100'	\$219.95	14658	20' x 150'	\$329.95
4452	24' x 100'	\$259.95	4391	24' x 150'	\$385.95
4350	28' x 100'	\$298.65			
3463	32' x 100'	\$329.95	11502	32' x 150'	\$499.95
14657	36' x 110'	\$369.95	11503	36' x 150'	\$569.95
2658	40' x 100'	\$429.75	4265	40' x 150'	\$639.95
4127	42' x 100'	\$459.75	13574	42' x 150'	\$659.95
2660	48' x 100'	\$509.95	4240	48' x 150'	\$749.65
10339	50' x 100'	\$546.95	10340	50' x 150'	\$795.00
13930	56' x 100'	\$589.95	11504	56' x 150'	\$899.45

Tufflite Infrared™ is a 4 year, 6 mil, energy saving greenhouse covering. Features Drip-Less™ technology, along with an additive that retains infrared waves, which improves nighttime heat retention. Also is light diffusing – reduces shadows. Use for the bottom layer in double layer

Tufflite Infrared™, Clear, 6 mil, 4 year					
Item #	Size	Price	Item #	Size	Price
4453	20' x 100'	\$239.95	14654	20' x 150'	\$359.85
4454	24' x 100'	\$282.95			
4491	28' x 100'	\$329.95			
3183	32' x 100'	\$369.95	11508	32' x 150'	\$549.95
11505	36' x 110'	\$429.95	11509	36' x 150'	\$627.35
3184	40' x 100'	\$469.95	4264	40' x 150'	\$698.95
10192	42' x 100'	\$499.15	11510	42' x 150'	\$726.55
2755	48' x 100'	\$569.95	4239	48' x 150'	\$839.95
11506	50' x 100'	\$599.25	11511	50' x 150'	\$819.95
11501	56' x 100'	\$623.25	11512	56' x 150'	\$956.25

Tufflite Nursery Clear™

Tufflite Nursery Clear™, 4 mil, 1 year					
Item #	Size	Price	Item #	Size	Price
10777	24' x 100'	\$142.95	3642	24' x 150'	\$215.45
2757	32' x 100'	\$188.55	12490	32' x 150'	\$282.35
2756	40' x 100'	\$237.15	13823	40' x 150'	\$357.35

Tufflite White Copoly, 70% Shade

A 4 mil, 1 season, greenhouse covering. Can be used for over-wintering, often used for dormant stock or on storage structures.

Tufflite White Copoly, 4 mil, 1 year					
Item #	Size	Price	Item #	Size	Price
11513	24' x 100'	\$145.55	11515	24' x 150'	\$214.75
4951	32' x 100'	\$193.35	11516	32' x 150'	\$289.45
11514	40' x 100'	\$239.95	11517	40' x 150'	\$366.95

KlerksKoolLite Plus



This 4 year, 6 mil, UV stabilized covering allows 84% light transmission, yet lowers greenhouse air temperature by 10 degrees compared to traditional greenhouse films. Also features light diffusion (53%), 2 sided anti-condensate, and IR additives that re-radiate nighttime infrared heat.

KoolLite Plus, 6 mil, 4 year					
Item #	Size	Price	Item #	Size	Price
11518	32' x 100'	\$435.20	11522	32' x 150'	\$653.00
11519	36' x 100'	\$489.60	11523	36' x 150'	\$735.00
11520	42' x 100'	\$571.20	11524	42' x 150'	\$856.00
11521	48' x 100'	\$652.80	11525	48' x 150'	\$1018.00

All Klerks greenhouse film also available. Allow 3 - 4 weeks.

Poly Patch Greenhouse Tape

A rugged patching tape for preventive maintenance in areas of extra stress and is perfect for mending greenhouse rips and tears. Clear, polyethylene tape with a medium tack acrylic-based adhesive with a white poly coated release



Item #	Description	Price
12491	Poly Patch Tape, 2" x 48'	\$ 8.95
2770	Poly Patch Tape, 4" x 48'	\$17.95
2769	Poly Patch Tape, 6" x 48'	\$25.95

Inflation Blowers

For inflating double layered film on greenhouses. 120Vac.

Pre wired with 8 ft cord.



Item #	Description	Price
3465	3 Bolt Blower, 60 CFM, 0.15A (18 W)	\$61.95
3466	3 Bolt Blower Mounting Kit	\$18.95
2921	4 Bolt Blower, 148 CFM, 0.5A (60 W)	\$74.95
3467	4 Bolt Blower Mounting Kit	\$18.95

Air Jumper Tube

Air jumper tubes with twist coupling ends. Used to jump air from main inflated part to side curtains and endwalls.



Item #	Description	Price
4262	24" Air Jumper Tube	\$16.95
4263	48" Air Jumper Tube	\$17.95

Inflation Fan

Brushless 12VDC, 0.22A (2.64 W) fan. Inflation unit includes a wirelock frame and clamps to connect to battery. 77 CFM.

Item #	Description	Price
11526	12VDC Muffin Fan Inflation Unit	\$78.95
11527	Replacement 12V Muffin Fan	\$28.95
14736	110VAC Muffin Fan Inflation Unit	\$39.85



Greenhouse Spacer Blocks

These spacer blocks are used to create an air layer between two layers of poly without the need for an inflation blower or electricity. They are commonly used where electricity is unavailable.



Item #	Description	Price	100+
11489	Greenhouse Spacer Block	\$5.95	\$5.70

White Felt Tape

White, 1/8" thick felt with an acrylic-based adhesive. Use to cover sharp edges or rough surfaces. Protects greenhouse hoops and components from wearing and tearing greenhouse film.

Item #	Description	Price
11490	White Felt Tape, 1 1/2" x 48'	\$19.95

White Vinyl Batten Tape

For securing plastic film to end walls, wood frame greenhouses, cold frames, etc. Just staple every 3-4" holding tape tight. 3/4" wide x 1/32" thick, 500 ft roll.

Item #	Description	Price
4773	3/4" x 500' Batten Tape	\$42.95

WireLock Poly Fastener

Poly fastener system that also works with shade cloth, insect and bird netting, etc. ZigZag wires lock the material in the WireLock channel. (ZigZag wire sold separately, see below). Can be used to splice poly. Can be formed to the top of curved bows. Holds to 4 layers poly and 2 layers ZigZag wire.



Item #	Description	Price	20+	60+
4213	8' Aluminum Single WireLock	\$7.95	\$7.45	\$6.95
4128	12' Aluminum Single WireLock	\$10.95	\$10.45	\$10.00

ZigZag Wire

For use with wirelock poly fasteners. Our Zig Zag wire is made from .085" diameter heavy duty, stainless steel spring wire double-tempered to allow for a better return to original shape.

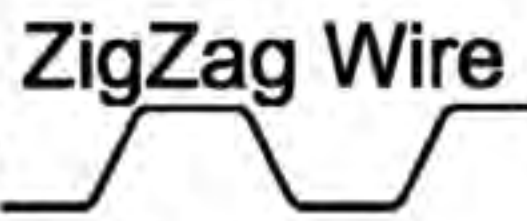

Item #	Description	Price	50/Bndl (200')
4129	4' ZigZag Wire	\$1.20	\$1.00 ea.= \$55.55

Double WireLock

Commonly used at the top of roll up sides which eliminates the need to run a supporting board vs single WireLock. Order ZigZag wire separately.



Item #	Description	Price	10+
10203	8' Aluminum Double WireLock	\$17.95	\$16.65
11895	12' Aluminum Double WireLock	\$26.95	\$25.25

Polycarbonate Sheeting

Clear twin-wall 8 MM polycarbonate sheeting. The perfect glazing choice for any greenhouse covering, translates its many unique features into cost saving benefits. Heavy Gauge: Increased strength. Improved hail protection. Anti Fog: prevents condensation buildup. Improved light transmission 10 year warranty. **Install with UV protected side toward exterior!**

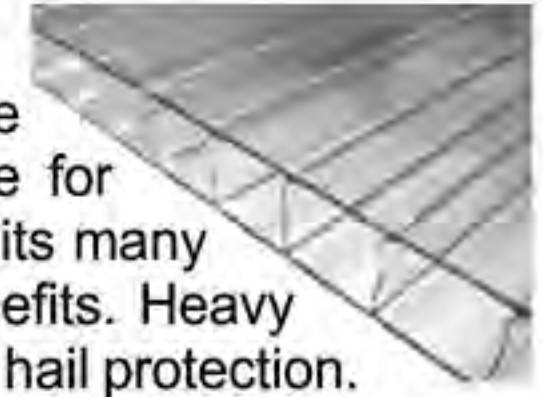

Item #	Description	Price	10+
4615	4' x 8' Polycarbonate Sheet, 8 MM	\$44.35	\$43.00
11491	4' x 10' Polycarbonate Sheet, 8 MM	\$56.00	\$54.80
5083	4' x 12' Polycarbonate Sheet, 8 MM	\$66.75	\$65.00
11492	4' x 14' Polycarbonate Sheet, 8 MM	\$77.90	\$75.60
10140	4' x 16' Polycarbonate Sheet, 8MM	\$89.95	\$88.00

We can custom order any length sheets (maximum 48').

Aluminum Extrusions for Polycarbonate

For 8 MM Polycarbonate sheeting. Double H is used to join two pieces. Single h is used to hold down edge or cover end.



Item #	Description	Price	20+
11493	12' Double H Extrusion	\$15.50	\$14.6
10142	12' Single H Extrusion	\$12.00	\$11.40

Tape and Washers for Polycarbonate

10145 is a 1" neoprene/metal bonded washer. Use with fasteners when securing polycarbonate. Aluminum tape can be used to close the top of polycarbonate. Vent tape is used to cover bottom of polycarbonate keeps bugs and dirt out while draining water and letting air in.



Item #	Description	Price
10145	1" Metal/Neoprene Washers, 100/bag	\$11.69
10142	2" x 150' Aluminum Foil Tape	\$12.00
11496	1 1/2" x 108' Vent Tape	\$29.95

End Bow WireLock

Use on gable end arch (bends to fit curved arch). Attach to top of arch with #12 x 1" Tek screws every 12" (see page 39). Cut polycarbonate to fit curve and slide underneath flange.



Item #	Description	Price
11497	12' End Bow Wirelock	\$21.95

Slide Clamps

This 3" wide pipe strap, no holes, is used for attaching double WireLock to greenhouse arches.



Item #	Description	Price
11498	1 3/8" Slide Clamp fits 1.315" OD pipe	\$1.95
11499	1 5/8" Slide Clamp fits 1.66" OD pipe	\$1.95
11500	2" Slide Clamp fits 1.9" OD pipe	\$1.95

Stainless Steel Screws

Tek Screws Hex head. Self drilling into metal.

Item #	Description	Bag Qty	Price	5+
12492	#10 x 3/4" SS Tek Screw	100/Bag	\$12.69	\$12.00
11594	#12 x 1" SS Tek Screw	100/Bag	\$16.95	\$16.30
11595	#12 x 1 1/2" SS Tek Screw	100/Bag	\$21.95	\$21.30
11596	5/16" Hex Driver Bit for above	—	\$ 2.25	—
11597	#14 x 1" SS Tek Screw	50/Bag	\$14.25	\$13.65
11598	3/8" Hex Driver Bit for above	—	\$ 2.69	—

Tek Screws Philips pan head. Self drilling through aluminum extrusions into wood.

Item #	Description	Box Qty	Price	5+
12513	#10 x 1 1/2" Philips Tek Screw	100/Box	\$19.50	\$18.90

Wood Screws with Washer 1/4" Hex head.

Item #	Description	Bag Qty	Price	5+
11600	#9 X 1 1/2" Wood Screw	250/Bag	\$37.50	\$35.00
11601	1/4" Hex Driver Bit for above	—	\$ 2.65	—

Deck Screws Star drive – no slipping. Bit included in each box.

Item #	Description	1 Lb. Box	Price	5+
11602	#9 x 1 1/2" Deck Screw	167 pieces	\$21.95	\$20.95
11603	#9 x 2" Deck Screw	124 pieces	\$21.95	\$20.95
11604	#9 x 2 1/2" Deck Screw	86 pieces	\$21.95	\$20.95

Cross Connectors

Don't Drill! Cross-Connect! Unique, 2-piece aluminum connector retains 100% of your frame's strength.



Item #	Description	Price	50+
10003	Connects 1.315" to 1.315" pipe	\$ 2.20	\$ 1.95
11579	Connects 1.315" to 1.66" pipe	\$ 2.26	\$ 2.20
11580	Connects 1.315" to 1.9" pipe	\$ 2.35	\$ 2.31

Metal Pipe Straps

These heavy-duty, 3 hole metal pipe straps are used to fasten purlins, windbraces, baseboards, etc. Has a predrilled hole on the round part of the strap for a third tek screw to keep it from sliding.



Item #	Description	Price	250+
10008	1" Pipe Strap, fits 1.315" OD pipe	\$0.59	\$0.49
10004	1 1/4" Pipe Strap, fits 1.66" OD pipe	\$0.75	\$0.69
11581	1 1/2" Pipe Strap, fits 1.9" OD pipe	\$0.79	\$0.69
14737	2" Pipe Strap, fits 2.375" OD pipe	\$0.89	\$0.79

Black Nylon Cable Ties, UV Treated

Item #	Length	Tensile Strength	Max Bundle Dia.	Bag Qty	Price
13999	4"	40 Lbs.	1-1/4"	100/Bag	\$ 4.20
14453	8"	40 Lbs.	2"	100/Bag	\$ 4.72
13594	11"	50 Lbs.	3"	100/Bag	\$ 6.30
14738	14"	120 Lbs.	4"	100/Bag	\$ 9.45

Gatorshield® Square Tubing

This heavy-duty 1 3/4" GatorShield® galvanized steel square tubing has Allied's superior, triple-layer rust and corrosion resistant product protection. Uses include: framing greenhouse gable ends, greenhouse benches, doors, etc.



Item #	Description	Price	25+
11658	1 3/4" Square Tubing, 13' 4" long	\$47.95	\$46.45
13935	1 1/2" x 24' long, 16 gauge	\$49.65	\$48.15

Splicer for Square Tubing

Fits inside 1 3/4" square tubing. Secure with tek screws. 8" length.

Item #	Description	Price
11583	Coupler for 1 3/4" Square Tubing	\$ 3.25
14739	Coupler for 1/2" Square Tubing	\$ 3.25

Metal End Wall Angle

Ell for connecting square tubing at right angles. Angle is 1 1/2" x 2" with three holes for fasteners. Tek screws are the recommended fastener.



Item #	Description	Price	100+
11584	Metal End Wall Angle	\$0.59	\$0.49

Brace Bands

Item #	Description	Price
11585	1.315" Brace Band	\$0.65
11586	1.66" Brace Band	\$0.69
10164	1.9" Brace Band	\$0.75
14740	5/16" Galv. Nut	\$0.08
14741	5/16" x 1-1/2" Galv. Carriage Bolt	\$0.14



End Wall Framing Brackets

Used to attach end wall framing to the gable end arch. Works with any wood or metal square tubing end walls. Size indicates size of brace band, match to your arch size.

Item #	Description	Price
10005	1.315" End Wall Framing Bracket	\$3.79
11587	1.66" End Wall Framing Bracket	\$3.89
11588	1.9" End Wall Framing Bracket	\$3.69



Extension Hangers

Heavy-duty S-hooks

Made from 10 gauge galvanized steel, these S-hooks can hold up to 35 pounds. 1 3/8" hooks on each end.

Item #	Description	Price
11589	6" S-hooks, 100/Box	\$25.50
4899	12" S-hooks, 100/Box	\$30.25
11590	15" S-hooks, 100/Box	\$32.80
11591	18" S-hooks, 100/Box	\$37.50
10319	24" S-hooks, 100/Box	\$42.75
11592	30" S-hooks, 100/Box	\$51.00
4900	36" S-hooks, 100/Box	\$53.00

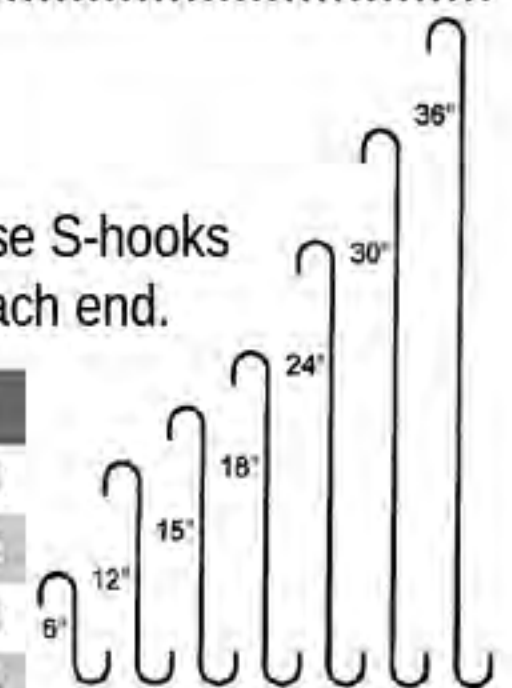

Greenhouse Roll Up Sides

Double WireLock fasten with pipe straps secures top cover and curtain

Rope Hook in Wirelock

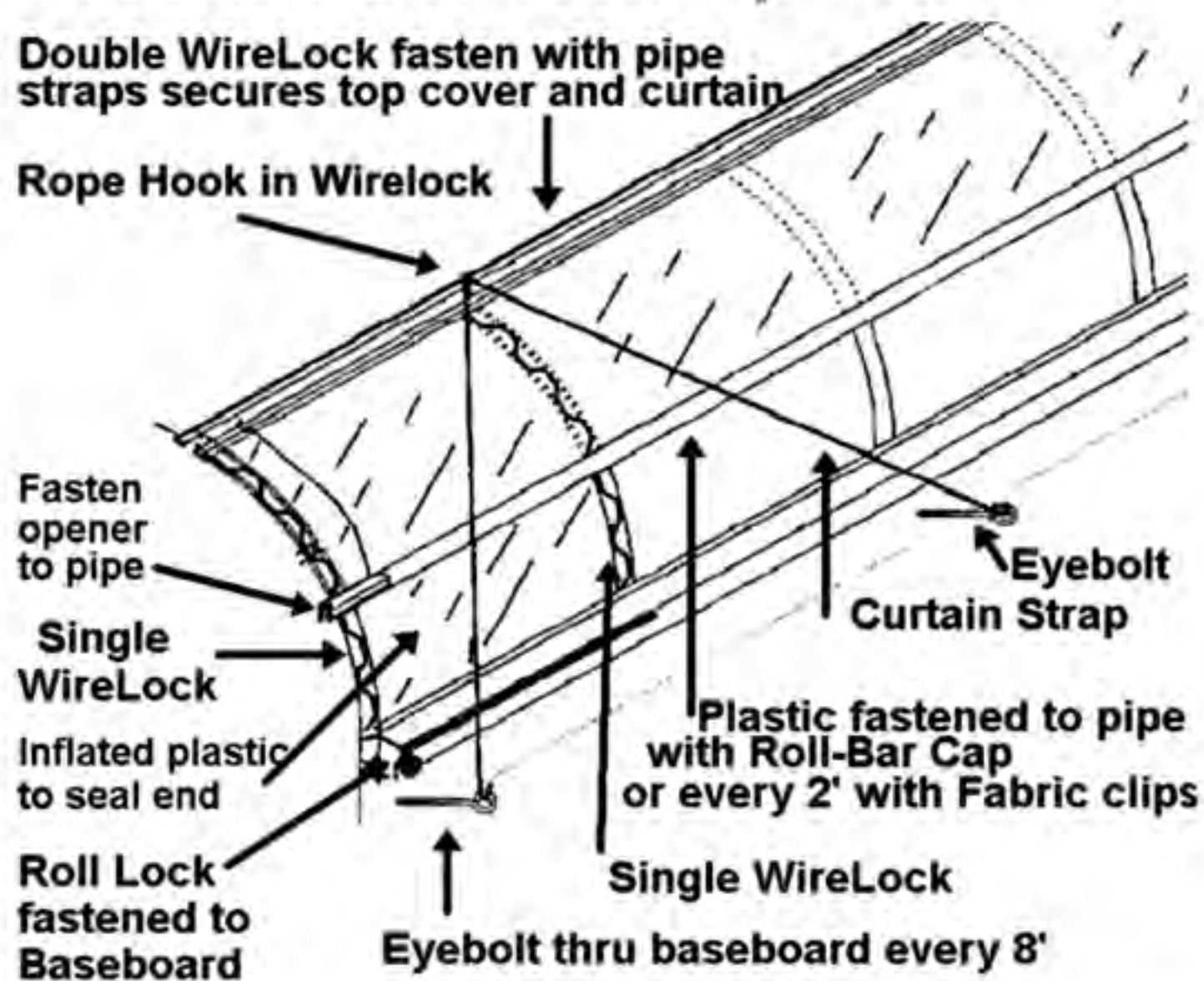

Use with Double WireLock & ZigZag Wire.

1.315" Galvanized Swedged Pipe, 17 ga.

For purlins or roll up pipe. 12' plus 3" swedge.

Item #	Description	Price	10+
3639	1.315" Purlin, 12' 3" length	\$18.75	\$18.25

Roll Bar Cap

Securely holds single or double layer plastic to 1.315" OD. roll pipe. Fasten with #12 x 1" Tek screws every 12"

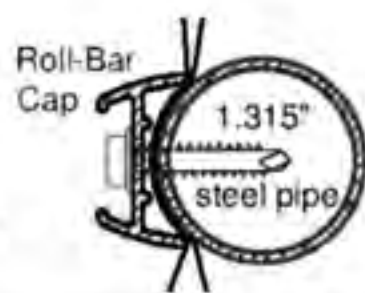

Item #	Description	Price	24+
10196	8' Roll Bar Cap	\$6.75	\$6.10

Aluminum Fabric Clips

Fastening plastic or shade cloth to pipe is a snap with fabric clips. Space every 2' on roll

Item #	Description	Price	100+
11569	3/4" Fabric Clip, fits 0.92" OD pipe	\$1.29	\$1.25
11570	1" Fabric Clip, fits 1.315" OD pipe	\$0.90	\$0.85
11571	1 1/4" Fabric Clip, fits 1.66" OD pipe	\$1.03	\$0.98
11309	1 1/2" Fabric Clip, fits 1.09" OD pipe	\$1.22	\$1.15

Side Clasp Roll Bar

Posi-Clasp's 2" OD aluminum Side Clasp Roll Bar is the "all-in-one" roll bar. This roll bar can be used on curtain systems up to 200'. Works great with Roll-Lock. The SCRBS uses Zig-Zag Wire (not included) to clasp one or two layers of curtain material into the built-in WireLock groove, allowing it to maintain its round shape as the curtain is rolled up.



Item #	Description	Price	8+
10994	12' Side-Clasp Roll Bar	\$36.95	\$35.50

Aluminum Roll-Lock

The Posi-Clasp Roll-Lock extrusion, creates a fully secured seal at the bottom of the roll up sides. Because of its superior seal it is recommended to use on heated structures. Enhances wind control and extends poly life. Splice plates are included.

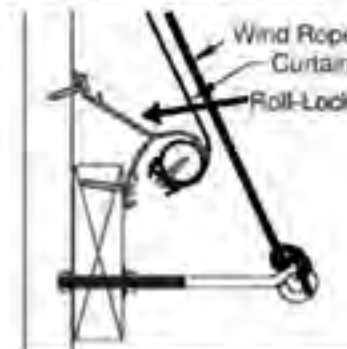

Item #	Description	Price	6+
11572	8' Aluminum Roll-Lock	\$35.95	\$34.95
11573	12' Aluminum Roll-Lock	\$51.95	\$50.95

Roll Pipe Installation Aids

Hangers (RPHRL & RPH2x) make roll bar installation quicker, easier & more uniform. Pipe hanger sets uniformly support 96' feet of roll pipe during installation. Hangers can be moved along greenhouse as installation progresses. Roll pipe deflector is for 2" baseboard. Install when not using Roll-Lock to deflect roll pipe out over edge of baseboard.

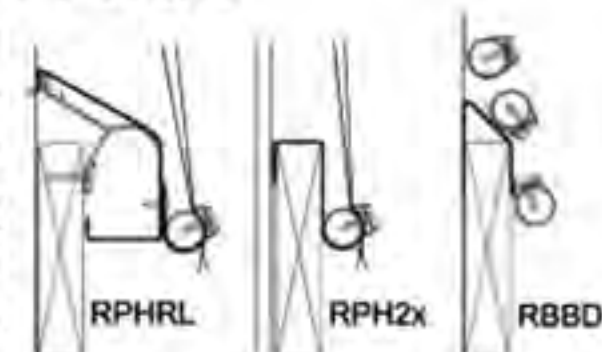

Item #	Description	Price
11574	1.315" Pipe Hanger, Roll-Lock, set of 9	\$41.95
14743	Side Clasp Hanger, Roll-Lock, set of 9	\$41.95
11972	Pipe Deflector for 2" baseboard, set of 9	\$19.95
11575	Roll Pipe Hanger, fits 2" baseboard, set of 9	\$21.95

Zinc Eye Bolts & Screws

Item #	Description	Price
10194	5/16" x 3" Eye Bolt, for baseboard w/o Roll-Lock	\$0.72
14743	3/8" x 6" Eye Bolt, for baseboard w/ Roll-Lock	\$1.12
11972	5/16" x 4" Eye Screw, for baseboard w/o Roll-Lock	\$0.82

Curtain Rope & Rope Hooks

Black Braided **Curtain Rope**, 1/4", 100% polyester. Aluminum **Rope Hook** inserts into WireLock without fasteners. Open hook for 1/4"



Item #	Description	Price
10237	1/4" x 350' Black Curtain Rope	\$38.95
10193	Aluminum Rope Hook, Pack of 25	\$24.00

Curtain Strapping

Item #	Description	Price
11577	2" x 600' Black Curtain Strapping, UV resistant	\$41.35

Handheld Poly Sealer

Seal 2 layers of poly together at curtain ends to allow roll up sides to inflate. Required for automatic inflation of Roll Up/Lockdown Systems that use the Roll-Lock extrusion. Features: 6" sealing length with teflon coated jaws. Seals PE, PVC, Cello, Mylar, and more. 115 volt, 25 watt



Item #	Description	Price
11578	Handheld Poly Sealer, 6" jaws	\$119.95

MANUAL GEAR CRANK OPERATOR PACKAGES

5:1 Ratio, internal brake. Needs to be reached from the ground. Uses 1" OD guide pipe. Rolls up to 96'.

Not for use with Roll Lock (use HD cranks).



ITEM	DESCRIPTION	PRICE
10190	5:1 Gear Crank, fits 1.315" roll pipe	\$89.55
10191	6' Guidepipe & Hanging Hardware for GFAM04	\$17.95

7:1 Ratio, Heavy-duty, internal brake. Includes 24" crank handle. Rolls up to 120', works with Roll-Lock. Fits 1.315" guidepipe and roll pipe.



13:1 Ratio, Heavy-duty, internal brake. Includes 24" crank handle. Rolls up to 240', works with Roll-Lock. Fits 1.315" guidepipe and roll pipe.



ITEM	DESCRIPTION	PRICE
4772	7:1 Gear Crank with 24" crank handle	\$138.95
11547	13:1 Gear Crank with 24" crank handle	\$179.85
11548	14" Drill Crank (For 4772 & 11547)	\$24.85
11550	120" Crank handle (For 4772 & 11547)	\$51.00
11551	Loop handle (For 4772 & 11547)	\$38.95

STEEL SWIVEL LOCK & HAND CRANK

Simple roll up crank. Includes locking universal joint and hand crank. Use 1.315" pipe to connect the pieces (not included). Pipe should be long enough so that handle locks against the ground.

Only recommended for rollup sides or doors are 36' or shorter.



MANUAL GEAR CRANK FOR DOORS

Doesn't require a guide pipe and allows the roll pipe to touch the ground. Ideal for doors or curtains that don't reach to the end of the structure. Stays attached to the roll pipe and is held at the correct height by securing handle to sidewall. 7:1 ratio with internal brake. Fits 1.315" roll pipe. 1.66" adapters also available.



ITEM	DESCRIPTION	PRICE
13370	7:1 Gear Crank with 3' long handle	\$176.85

LOW VOLTAGE CONTROLLERS

For ventilation control on roll up sides and roof vents with low voltage motor packages. 110VAC input, 24VDC output. Also controls heaters and fans. All controllers have manual override.



11552

Tired of using multiple thermostats? We sell custom touch-screen controllers to control all ventilation and heat in your greenhouses.



11553

For quote call with your requirements!

ITEM	DESCRIPTION	PRICE
11552	Controller; 1 stage of rollups (1 or 2 motors) + 2 stages dry contacts for heaters, fans, etc.	\$739.65
11553	AegisTEC Touchscreen Controller; 2 stages of rollups (3 motors) + 2 stages contacts for heaters, fans, etc. With timed, weather & humidity override options. Sensors sold separately.	\$995.00
13442	AegisTEC-Plus Touchscreen Controller; Same as above except more capacity. Dual zone capable (2nd sensor needed).	\$1695.00
11556	Contractor to run fans, max 25 amps	\$155.00
14745	Humidity Sensor, override for all above	\$345.95
14746	Rain Sensor, override for AegisTEC	\$233.95
14747	Anemometer, Wind override for AegisT	\$229.95

Also available: Solar powered controllers and interface boxes to accept signals from other controllers.

LOW VOLTAGE MOTOR OPERATOR PACKAGES

Energy efficient yet powerful! 24VDC motors for above controllers. Rolls up to 6 x 200 curtain. Includes roller guide, adapter for 1.315" roll pipe and guidepipe hardware. Use 1.315" guidepipe.



ITEM	DESCRIPTION	PRICE
11558	60NM, rolls up to 5' x 200' curtain	\$289.95
11559	Limit Switch required if using with Roll-Lock	\$96.95

SOLARSIDE® WOVEN CURTAIN POLY

Great for rollup curtains, rollup doors or gable end covering.

- More durable and puncture resistant than 6mil poly.
- Lightweight and extremely strong
- Diffuses light evenly
- UV Stabilized
- 87% Light transmission
- 6.8 oz/sq. yd.



ITEM	DESCRIPTION	1'-99'	100'-199'	200'+
12686	6' Solarside Reinforced Poly	\$2.00	\$1.88	\$1.78
12693	13' Solarside Reinforced Poly	\$3.88	\$3.66	\$3.46

Greenhouse Doors

Greenhouse doors, ready to install. High quality aluminum construction with two polycarbonate windows.

Optional: Tempered glass for top window.

Allow 4-6 weeks lead time.

Except sizes marked with #, which we try to keep in stock.

Single Sliding: Optional – add \$14.50 for Bottom Seal Brush

All Polycarbonate			With Temp. Glass Top Half		
14753	3' x 7'	\$635.00	14756	3' x 7'	\$655.00
14754	3' x 8'	\$675.00	14757	3' x 8'	\$687.00
12277	4' x 7' #	\$665.00	14758	4' x 7'	\$695.00
14755	4' x 8' #	\$690.00	14759	4' x 8'	\$755.00

Includes: Standard Latch, Brushes (two sides & top), Aluminum Track & Rollers, 2 Pull Handles, 1 Stay Roller, and 1 Door Guide

Double Sliding: Optional – add \$29.00 for Bottom Seal Brush

All Polycarbonate			With Temp. Glass Top Half		
14760	3' x 7'	\$975.00	14762	3' x 7'	\$1050.00
14761	3' x 8'	\$1065.00	14763	3' x 8'	\$1085.00
13281	4' x 7' #	\$1045.00	14767	4' x 7'	\$1095.00
11754	4' x 8' #	\$1125.00	14768	4' x 8'	\$1195.00

Includes: Standard Latch, Brushes (two sides & top), Aluminum Track and Rollers, 4 Pull Handles, 2 Stay Rollers, 1 Cane Bolt, 1 Door Stay and Fasteners.

Single Hung

All Polycarbonate			With Temp. Glass Top Half		
14365	3' x 7' #	\$635.00	14771	3' x 7' #	\$655.00
14769	3' x 8'	\$675.00	14772	3' x 8'	\$725.00
12601	4' x 7' #	\$675.00	13328	4' x 7'	\$725.00
14770	4' x 8'	\$725.00	14773	4' x 8'	\$775.00

Includes: Commercial Lever Latch, 1 Door Stop, 1 Bottom Sweep & Fasteners. **Outswing with hinges on left (outside).**

Basic Roll-up Doors for High Tunnels

We can quote based on the size needed. Up to 9'x23' for our 30' structures.

Use: 6.8 oz woven curtain poly, single wirelock across the top, 2 runs (center and bottom) of 1.6" galvanized pipe with roll-bar cap and a low wall gear crank or swivel lock and hand crank for smaller doors.

Pictured: Basic roll-up doors with swivel lock and hand crank and regular 6 mil plastic.



DCBI Corrugated Metal Roll-up Doors

26-gauge galvanized, polar white, grade E hard steel curtain with 5/8" ribbed corrugation. All models listed below are wind rated at 90 plus MPH. Unlike most other brands these doors have corrugated drum to prevent misalignment and for quieter operation. 9-1/2 to 12" drum diameter (depending on door size). For more info visit www.dcbi.com. We can custom order most any size. Also available with interior Mylar insulation. Call for quotation.

Item #	Description	Price
15310	16' wide x 9' high, HD Series 3000, w/chain hoist, wind clips, ACE guide system	\$2095.00
15311	10' wide x 9' high, Series 690, 16 ga galv steel guides & windbar, no chain hoist	\$1299.00
4582	8' wide x 8' high, Series 650, 18-gauge galv steel guide system, no chain hoist	\$869.95



Pictured: 3' x 7' Double Hung (view from inside of the door)

Double Hung

All Polycarbonate			With Temp. Glass Top Half		
14281	3' x 7'	\$1028.00	14282	3' x 7'	\$1033.00
14774	3' x 8'	\$1095.00	14776	3' x 8'	\$1145.00
14775	4' x 7'	\$1095.00	14777	4' x 7'	\$1150.00
13700	4' x 8'	\$1165.00	14778	4' x 8'	\$1235.00

Includes: Commercial Lever Latch, 2 Door Stops, 2 Bottom Sweeps, 1 Pull Chain, 1 Cane Bolt Fasteners and Center Astragal. **Main door is Outswing with hinges on left (outside).**

Aluminum Shutters



These aluminum shutters from J&D are designed to be used as an inlet, but may also be used for free-air exhaust. Nylon bushings, solid shafts, drawn cup-type sleeves on all movable linkages.

Item #	Description	Price
12709	16" Single Panel Shutter	\$52.00
4925	24" Single Panel Shutter	\$92.55
12976	30" Single Panel Shutter	\$122.75
12666	36" Double Panel Shutter	\$166.40
13330	40" Double Panel Shutter	\$197.60
11704	42" Double Panel Shutter	\$208.00
12298	48" Double Panel Shutter	\$223.60
13701	54" Double Panel Shutter	\$260.00
14780	60" Double Panel Shutter	\$312.00

For rough opening size for shutters: add 1/2" to shutter size (both dimensions).



Heavy Duty ACME Shutters Also Available in 36" and 48"

Shutter Motor Kits

Works with all the above shutters. 115/230V. Includes: motor, lever arm, chain, s-hooks, tension springs, mounting bracket and assembly hardware.



Item #	Description	Price
10481	Shutter Motor Kit	\$112.95

Univent Automatic Opener

Can be adjusted to open at between 60°-70°F. Fully open at 86°F. Works on 30" & smaller aluminum shutters (see above). Opens window/vent up to 18". Lifts up to 33 lbs.



Item #	Description	Price
10204	Univent Automatic Opener	\$47.95
12708	Hardware to mount to above shutters	\$2.65

Shutter & Slantwall Fans



Shutter Fan, shown above left: features heavy-duty combination motor mounted/safety guard with bright easy-to-clean zinc-chromate finish.

Slantwall Fan, shown above right: features galvanized box, Direct drive motors, except 11610 and 11611 are belt drive, wire mesh guard. 11611 features cone for better performance.

Item #	Size	CFM	HP/RPM	Rough Opening	Price
11605	12"	970	1/10 hp/1,625	12-5/8"	\$215.95
11606	16"	1,440	1/10 hp/1,625	16-5/8"	\$228.00
4926	20"	3,140	1/3 hp/1,725	20-5/8"	\$349.95
11607	24"	4,640	1/2 hp/1,725	24-5/8"	\$389.00
11608	30"	6,770	1/2 hp/825	30-5/8"	\$448.00
11609	30"	7,100	1/2 hp/825	38"Hx37"W	\$879.55
11610	36"	9,700	1/2 hp belt drive/525	42"Hx41"W	\$1395.45
11611	50"	21,600	1 hp belt drive/588	57"Hx55"W	\$1653.00

Circulation Fans



With 10' cord, pre-wired for 115 volts, single phase. Totally enclosed, maintenance-free, direct drive high-efficiency motors have completely sealed ball bearings. Motors are variable speed capable (controller must be sourced separately).



Item #	Description	Price	4+
11543	20" EZ-Breeze Fan, 1,680 CFM 1/10 hp, 1.08 amps	\$162.95	\$158.95

JHF12 and JHF20: Front can be opened for cleaning.

11783	12" Green Breeze Fan, 970 CFM 1/10 hp, 1.12 amps	\$179.95	175.95
4805	20" Green Breeze Fan, 3,650 CFM 1/3 hp, 3.52 amps	\$317.95	\$310.95

Circulation Fan HESSAIRE VENTILATION

This 12" Hessaire circulation fan features industrial grade aluminum blades. Guards are powder coated. Bracket included. Single phase, 115V, 1.0A, 1/10 hp motor. **1,085 CFM**



Item #	Description	Price	4+
11544	12" Hessaire Circulation Fan	\$106.95	\$103.95

Euroemme Heavy-Duty Exhaust Fans

Centrifugal shutter system keeps the efficiency of the fan at peak all the time by keeping the shutters fully open. Shutters do not have to be cleaned regularly. Heavy duty galvanized shutters are tightly closed when the fan is not in operation, preventing any air leakage. Considering the effect of dirty shutters on the other slant wall fans, the efficiency of the Euroemme fan is 15-25% better than any other fan.



Item #	Size	CFM @ 0" Static Pres.	Motor	Rough Opening	Price
11545	36"	11,650	1/2 hp	43"	\$1,295.45
11546	50"	20,500	1 hp	54 1/2"	\$1,495.00

A complete ventilation system is essential for all greenhouse applications.

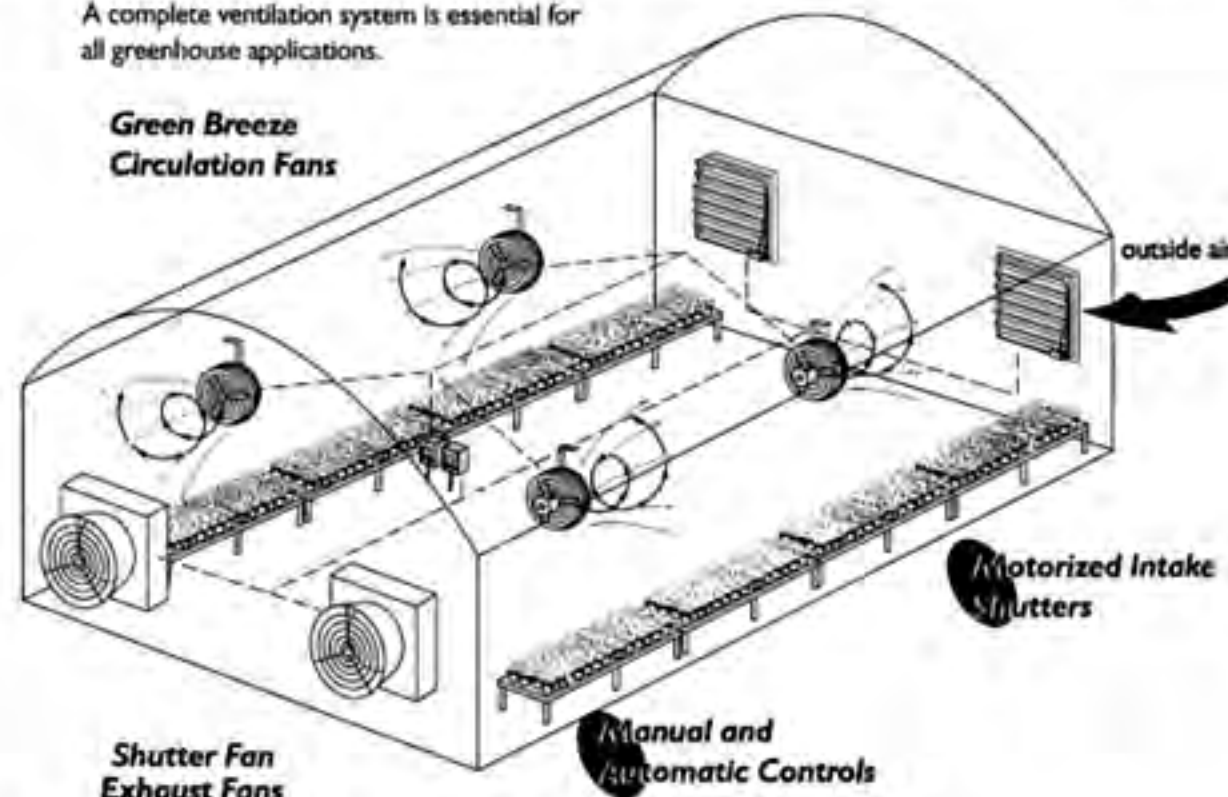

Modine Gas-Fired Unit Modine Model PTP

Stainless Steel Heat Exchangers for longer life. 80% Efficiency. Modine's horizontal power vented PTP unit heater line. Electronic Ignition with 100% shutoff and continuous retry. Power vent does not require vertical vent pipe.



Item #	BTU/hr Input/Output	CFM	Vent Size	Weight	Price
11560	150,000/120,000	2,140	4"	165 Lbs	\$1,375.00
11561	175,000/140,000	2,725	4"	210 Lbs	\$1,459.00
4906	200,000/160,000	2,870	4"	220 Lbs	\$1,495.00
14781	250,000/200,000	3,995	6"	265 Lbs	\$1860.00
14153	300,000/240,000	4,545	6"	270 Lbs	\$1,995.00

Modine Model PDP

80% Efficiency. Modine's vertical power vented PDP unit heater line. Electronic ignition with 100% shutoff and continuous retry. Power vent does not require vertical vent pipe.



Item #	BTU/hr Input/Output	CFM	Vent Size	Weight	Price
11562	150,000/120,000	2,180	5"	168 Lbs	\$1,359.00
10328	175,000/140,000	2,550	5"	175 Lbs	\$1,469.00
11564	200,000/160,000	2,870	5"	239 Lbs	\$1,495.00
11563	250,000/200,000	3,700	6"	239 Lbs	\$1,865.00

All Modine heaters are for LP gas (propane) unless otherwise specified. **ITEM #'s MARKED * ARE ALSO STOCKED FOR NATURAL GAS.** Specify when ordering by adding "N" to the item #'s (e.g. MPTP150N) We can also order other models for natural gas (4-6 weeks leadtime)

Thermostats

These corrosive environment thermostats can be wired for heating or cooling. Up to 240Vac. SS sensor. Temperature range: 40°-100°F.

Item #	Description	Price
4774	Single Stage Thermostat	\$33.95
13931	2 Stage Peco Thermostat Can be wired for 2 speed.	\$91.55
11566	Waterproof Cord Connector	\$5.95



Twister Exhaust Fan

For Convection Tubing (will reduce CFM) Galvanized Exhaust/Tube Fan, has center hinged galvanized butterfly shutter that can easily be removed for tube applications.

Item #	Description	Price
11568	24" Fan, 4820 CFM, 1/3 hp motor	\$469.95



When ordering please specify
Propane or Natural Gas



Modine Effinity93

Modine Model PTC. With Stainless Steel Heat Exchangers for longer life. At 93% efficiency, Modine's Effinity⁹³ is the most efficient condensing unit heater in North America. Direct Spark Ignition. Power Exhaust. High Efficiency Separated Combustion. Use PVC Vent pipe, use same size pipe for combustion air inlet. (Do not draw combustion air out of greenhouse.) Drains an acidic condensate. *Vent and drain must be installed properly.*



Item #	BTU/hr Input/Output	CFM	Vent Size	Weight	Price
13575	85,000/79,050	1,650	3"	125 Lbs	\$2,595.00
14782	135,000/125,550	2,160	3"	165 Lbs	\$3,695.00
14783	180,000/167,400	3,020	4"	215 Lbs	\$3,995.00
14784	215,000/199,950	3,865	4"	265 Lbs	\$4,595.00
13329	260,000/241,800	4,585	4"	265 Lbs	\$4,895.00

Modine Hot Dawg®

Electronic Ignition with 100% shutoff and continuous retry. Power vent does not require vertical vent. 80% Efficiency.



Item #	BTU/hr Input/Output	CFM	Vent Size	Weight	Price
13390	45,000/36,000	720	3"	60 Lbs	\$795.00
12667	75,000/60,000	1,160	3"	85 Lbs	\$895.00
14170	100,000/80,000	1,490	4"	125 Lb	\$1,065.00
13025	125,000/100,000	1,980	4"	128 Lb	\$1,095.00

Convection Tubing

Kenbar convection tubing is made from clear polyethylene and is protected with a strong ultraviolet inhibitor. The plastic is formulated for maximum light penetration and for durability in a greenhouse environment.



Convection Tubing Punch Positions

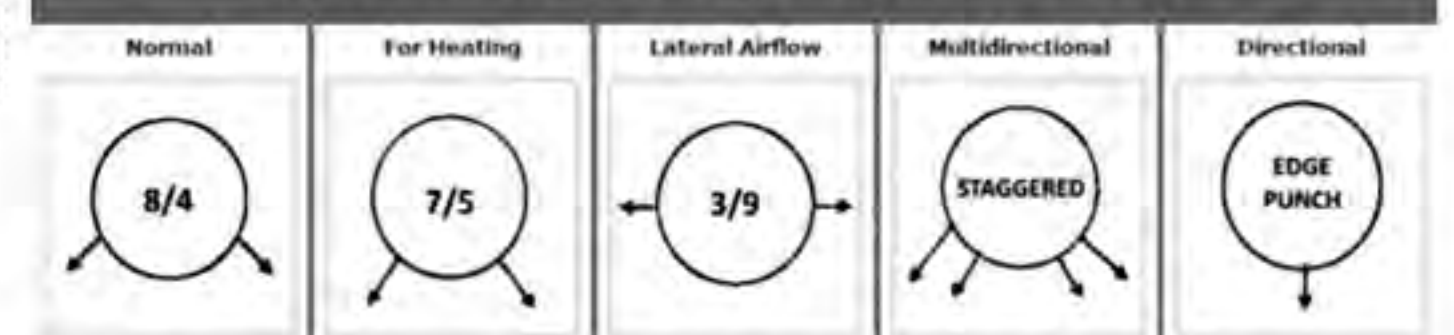

8/4 punch is standard unless otherwise specified.
For staggered or edge punch add \$0.12/ft.

Item #	Description	Price/ft
14785	12" Dia. Tubing, 6 mil 3 year	\$0.90
12786	18" Dia. Tubing, 6 mil 3 year	\$1.11
12038	24" Dia. Tubing, 6 mil 3 year	\$1.45
14786	30" Dia. Tubing, 6 mil 3 year	\$1.75

Small Order Up charge on orders less than \$50.

GREENHOUSE SUPPLY

Thermalarm II

Metal contacts close this normally open switch when temperatures exceed the limits you set. Temperature range: 20°–110°F. No magnetic switch, no relay needed. 6–12 volts.



Item #	Description	Price
14787	Thermalarm II	\$48.95

Prewired Temperature Alert

Low and high temperature alert. This sensor, made from a pair of our single stage mechanical thermostats, features superior accuracy and reliability, and will be less likely to corrode or stick than a Thermalarm. Set your desired temperature limits between 40° and 110°F. Labeled, easy to test, no relay needed, wired for up to 24 volts. Prewired with 6' wire to battery and 60' to siren. *Battery and siren not included.*



Item #	Description	Price
14150	Prewired Temperature Alert	\$106.95

Sirens



14079



14080



14081

Item #	Description	Price
14079	Outdoor Siren, Dual Tone, 115 dB, 6–12 VDC	\$26.95
14080	Indoor Siren with strobe, 110 dB, 6–12 VDC	\$19.75
14081	12V Lantern Battery, thumb screw terminals	\$20.95

EasyAlert Wireless Alarm System

This wireless alarm system is an advanced monitoring system that allows you to connect up to 16 wireless sensors, plus hardwired sensors. **Wireless sensors have a range of up to 1 mile** (line of sight), making this the ideal alarm system to monitor your property without running wires to every structure. With battery backup, the alarm will continue to monitor during a power failure.

Customizable: This system isn't limited to temperature monitoring.

Wireless Alarm System Base: Packaged with 110VAC charger and 1 temperature sensor, pre-programmed and ready to use. Enclosed in a plastic case with a speaker that produces a sharp chime when a transmitter is triggered. Adjustable volume. Can be programmed to produce a unique chime for each transmitter. If you put the base in your house, these chimes can wake you up. Or in an outbuilding we recommend you connect it to an outdoor siren. It has a **built-in power failure & low battery alarm**. Programming is done in the base, eliminating the need for a computer.

Hi/Lo Temperature Sensor monitors air temperatures. High and low temperature set points can be set between 40° and 110°F. Wireless, uses 4 AA batteries. Sensor is a pair of weatherproof thermostats with a built in transmitter. By using these mechanical thermostats it makes for a very reliable easy to use transmitter.

Sensaphone®

Remote Monitoring. Protect your investment even when you can't be there. Monitors your unattended facility to detect power failures, temperature extremes, intrusions, water incursion, sounds such as smoke and burglar alarms, and other conditions of your choice.



Alerts you immediately if problems arise. In case of alarm automatically contacts you by phone at up to four (Sensaphone 400) or eight (Sensaphone 800) different phone numbers.

The system communicates in voice synthesized English. Call in any time from any phone for status reports which include power status, temperature, zone status, and also lets you listen to actual sounds onsite.

Includes built-in sensors to monitor a variety of conditions: High sound level; AC electric power failure; Battery backup; Temperature (uses 1 input). Configurable inputs work with temperature sensors and normally open & normally closed switch type sensors. If you use SEN2 Prewired Temperature Alert or GEA300 Thermalarm II you can parallel wire multiple units to one input.

Works on regular phone lines and/or on fax lines. Will not interfere with operation of answering machine and will not answer except selectively. **Fully and easily programmable.**

Item #	Description	Price
SEN400	Sensaphone 400, 4 configurable inputs, dials up to 4 phone numbers	\$469.95
SEN800	Sensaphone 800, 8 configurable inputs, dials up to 8 phone numbers	\$685.00
SEN101	Weatherproof Temperature Sensor, 12' Wire	\$ 37.45

If you use SEN2 Prewired Temperature Alert or GEA300 Thermalarm II you can parallel wire multiple units to one input.



WA1710 Transmitter



WA1714 Solar Panel



WA1700 Alarm Base

Item #	Description	Price
WA1700	Alarm Base & 1 Hi/Lo Temperature Sensor	\$623.00
WA1710	Additional Hi/Lo Temperature Sensor	\$229.00
WA1714	Optional Solar Panel 12VDC Battery Charger	\$ 65.00
WA1716	Voice Dialer, Custom add on for base	\$187.00

Can be used with sirens (above) or with other 12V alarms. **Custom Options:** Solar Panel recommended when 110VAC isn't available. Voice Dialer—calls up to 5 phone numbers when alarm is triggered. We can customize. **Call us with any questions.**

STOCK Greenhouse Frames Extended Lead Times. Prices subject to change without notice.

Manufactured in Dundee OH, all the greenhouse and high tunnel frames on this page and page 47 feature triple galvanized tubing for years of service. Call for pricing on any length frames, custom arch spacing, higher side walls and crossties, or rack & pinion roof vent.

21' Peaked High Tunnel, 5' Straight Sides

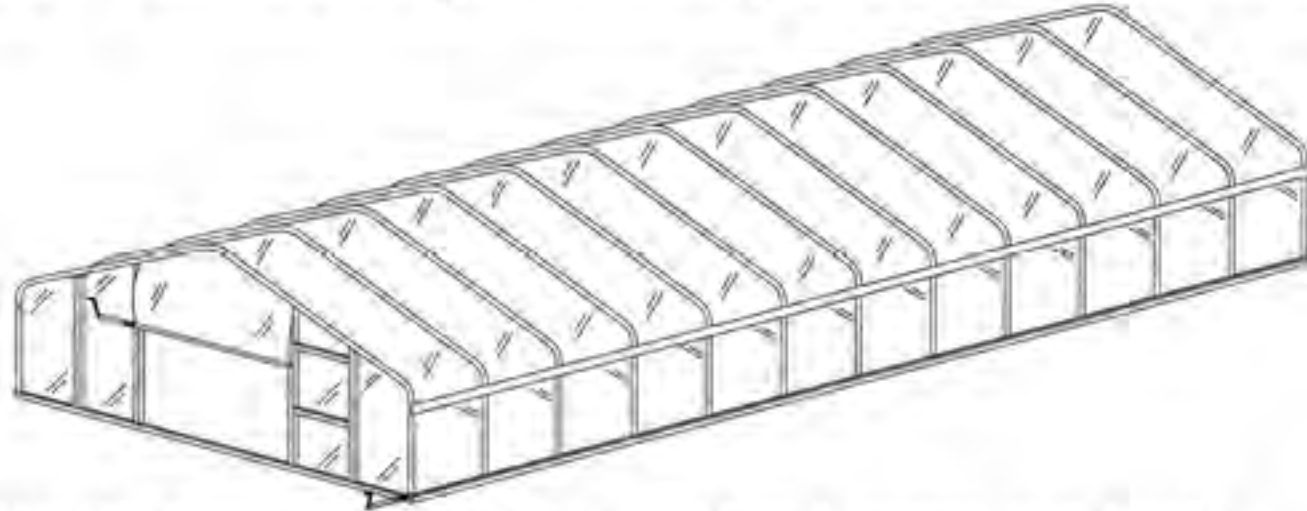

This 21' frame is 10½' to peak and has 3 purlins and 4 wind braces. Hardware includes: cross connectors and pipe straps for fastening purlins, pipe straps and bolts for baseboard, end wall brackets assembly instructions and stake driver. Uses 35' wide plastic cover. Optional Crossties 1.315" x 14ga w/1 upright brace. Also available with round arch, as pictured on catalog.

Size	Price	Item #	Opt' 1 7' Cross Ties
21' x 24'	\$1,685.00	15312	Add:\$208.00
21' x 48'	\$2,795.00	15222	Add:\$458.00
21' x 72'	\$3,985.00	13695	Add:\$702.00
21' x 96'	\$4,995.00	14865	Add:\$446.00

24' Gothic Greenhouse, 4' Straight Sides

Arches 1.660" x 14 ga
Stakes 1.900" x 13 ga
Crosstie 1.315" x 14 ga
Braces 1.315" x 16 ga
Purlins 1.315" x 17 ga

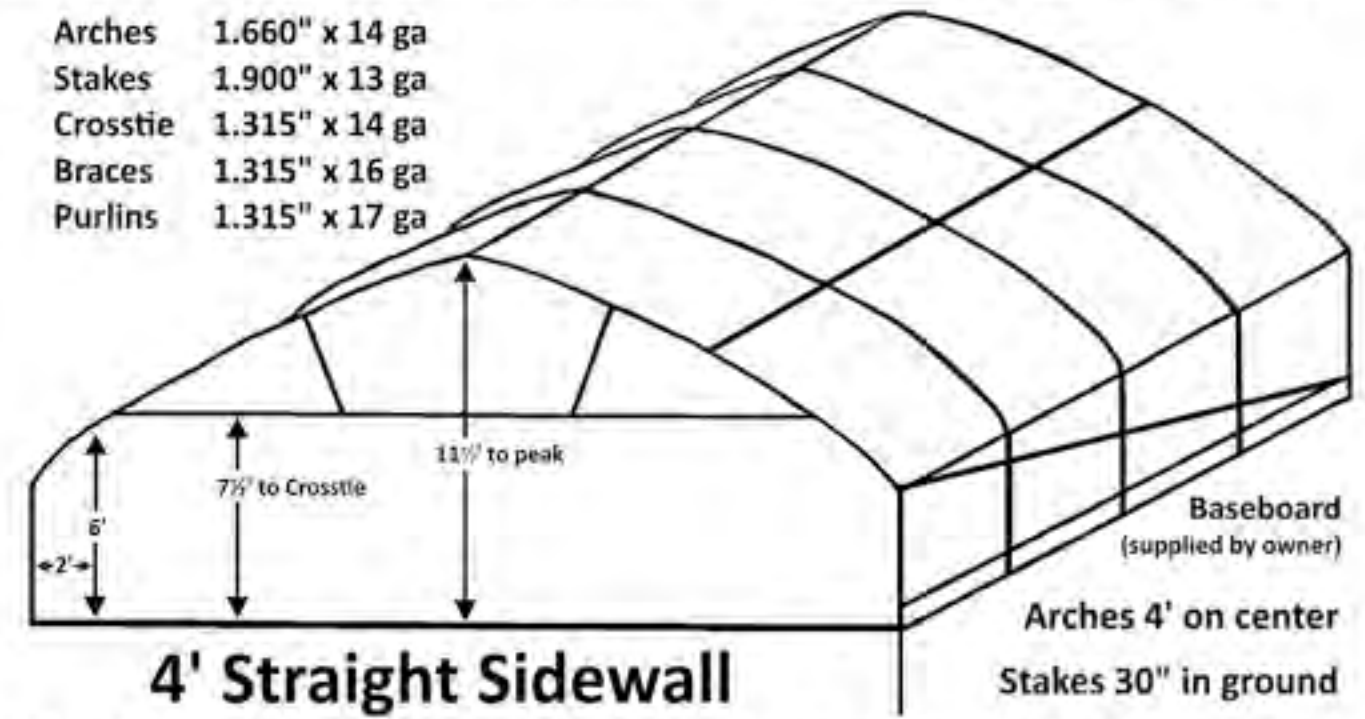

This 24' frame has crosstie assembly on each arch except end arches, 3 purlins and 4 wind braces. Hardware includes: heavy duty cross connectors and pipe straps for fastening purlins, pipe straps for baseboard, end wall brackets, assembly instructions and stake driver. Uses 39' wide plastic cover.

Size	Price	Optional 5½' Sidewall add:
24' x 48'	\$3078.00	\$81.00
24' x 72'	\$4420.00	\$119.00
	\$5740.00	\$156.00

12' & 16' Quonset Greenhouses

Both 12' & 16' have 3 purlins and 4 wind braces. Includes pipe straps for fastening purlins, pipe straps and bolts for baseboard, end wall brackets assembly instructions and stake driver.

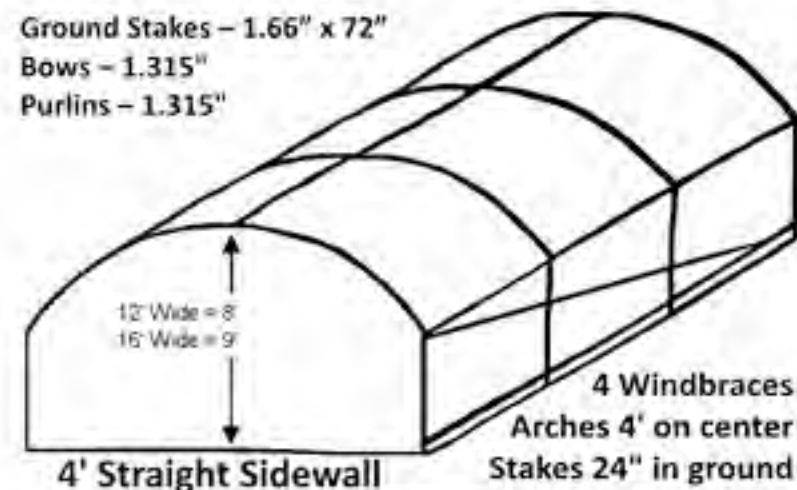

Length	12' Wide	16' Wide
24'	\$1050.00	\$1229.00
48'	\$1789.00	\$2145.00
72'	\$2489.00	\$2995.00
96'	\$3135.00	\$3995.00

12' uses 24' wide plastic cover,
16' uses 28' wide plastic cover.

20' Cold Frame (No snow load claim.)

Ground Stakes - 1.66" x 72"
Bows - 1.315" 14 ga.
Purlins - 1.315"

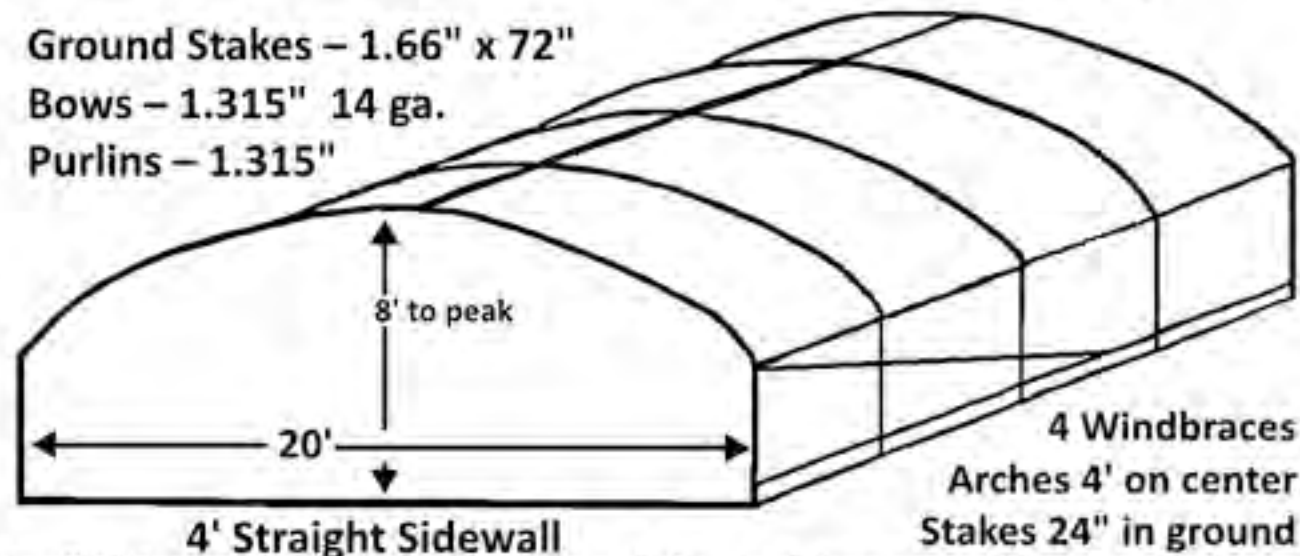

This 20' frame has 3 purlins and 4 wind braces. Also includes pipe straps, end wall brackets, bolts & screws, and stake driver. Uses 32' wide plastic cover.

Size	Price	Size	Price
20' x 24'	\$1029.00	20' x 48'	\$1799.00
20' x 72'	\$2548.00	20' x 96'	\$3250.00

Individual Frame Components

Item #	Description	Price
11531	12' wide, 1 piece Bow, 1.315" 16 ga	\$65.00
11532	16' wide, 1 piece Bow, 1.315" 14 ga	\$79.00
11533	20' wide, 1 piece Bow, 1.315" 14 ga	\$87.75
11534	21' wide, 1 piece Bow, 1.66" 14 ga	\$112.50
11535	72" Ground Stake, 1.66" 13 ga	\$17.00
11536	78" Ground Stake, 1.90" 13 ga	\$22.95
11537	96" Ground Stake, 1.90" 13 ga	\$24.00
11538	Ground Stake Driving Head, for 1.66"	\$12.00
11539	Large Ground Stake Driving Head, for 1.9"	\$16.00

Galvanized Purlins/Pipe



Item #	Description	Price	Qty Price
11540	0.922" x 10' Purlin, swaged, 18 gauge. Put on top of crossties for hanging baskets	1-24 \$12.95	25+ \$11.75
3639	1 3/8" x 12' 3" Purlin, swaged, 17 gauge For roll-up pipe, purlins, etc	1-9 \$18.75	10+ \$18.25
11541	1.66" x 24' Purlin, 3" swage, 13 gauge, For ground stakes or HD purlin		Full 24' pc \$68.95
11542	1.9" x 24' Purlin, 13 gauge, no swage. For ground stakes		Full 24' pc \$77.95



30' Standard Gothic Greenhouse

- Arches 1.660" x 14 ga
- Stakes 1.900" x 13 ga
- Crosstie 1.315" x 14 ga
- Braces 1.315" x 16 ga
- Purlins 1.315" x 17 ga

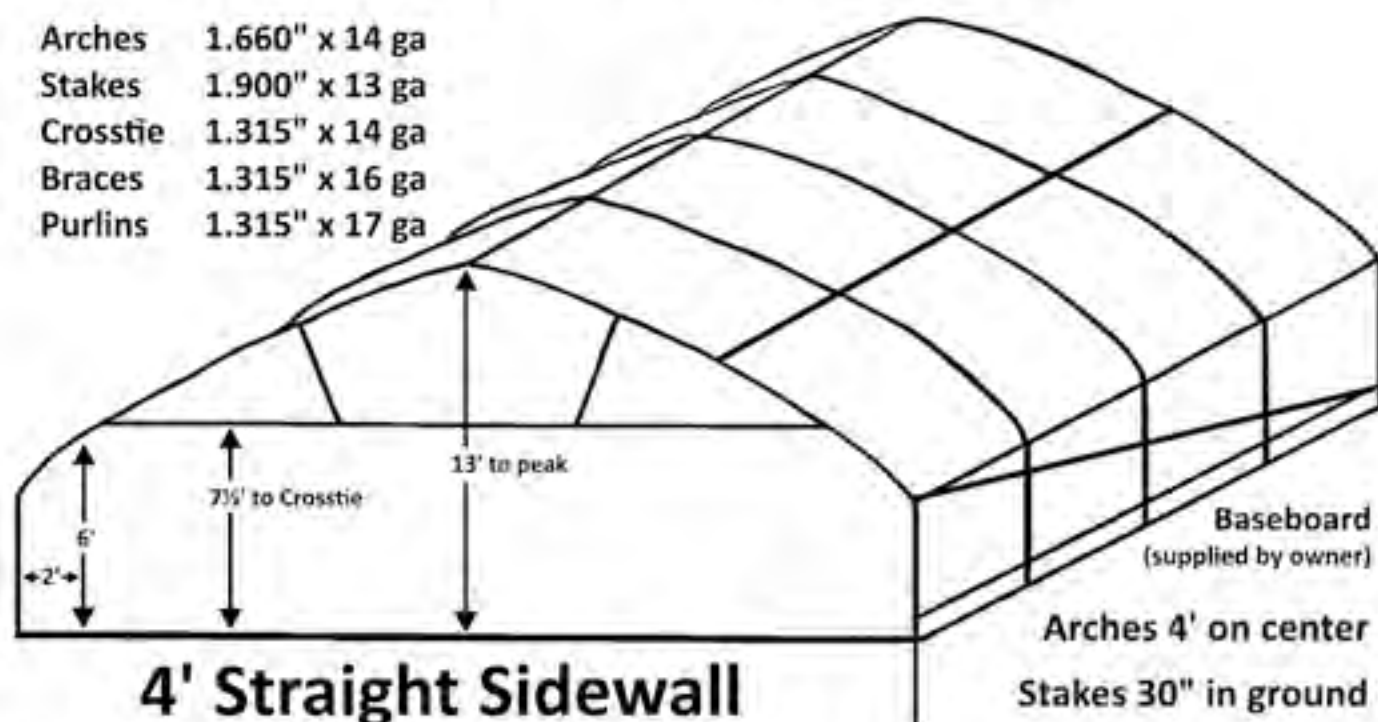

This 30' frame has crosstie assembly on each arch except end arches, 5 purlins and 4 wind braces. Hardware includes: heavy duty cross connectors and pipe straps for fastening purlins, pipe straps for baseboard, end wall brackets, assembly instructions and stake driver. Uses 46' wide plastic cover.

Size	Price	Optional 5 1/2' Sidewall add:
30' x 48'	\$4,675.00	\$81.00
30' x 72'	\$6,750.00	\$119.00
30' x 96'	\$8,695.00	\$156.00
30' x 144'	\$12,750.00	\$231.00

Optional Rack & Pinion Roof Vent

A roof vent is the most efficient natural ventilation when combined with roll up sides. Recommended to use with automated controller and low voltage motors. But also available with chain wheel for manual operation. Can be added to any of our 21', 24', 30' & 34' structures. **Call for more information or pricing.**

30' Northern Gothic Greenhouse

This 30' frame has same specifications as the one to the left except: **1.9" 13 gauge arches** with 6" long swedge to insert into ground stake. This makes it stronger and capable of carrying more snow load. **Recommended for heavy snow fall areas.**

Size	Price	Optional 5 1/2' Sidewall add:	Optional W bracing for crossties
30' x 48'	\$4,675.00	\$81.00	\$348.00
30' x 72'	\$7,950.00	\$119.00	\$520.00
30' x 96'	\$10,285.00	\$156.00	\$686.00
30' x 144'	\$12,750.00	\$231.00	\$1,035.00

34' Gothic Greenhouse, 4' arch spacing

This 34' frame has same specifications as the 30' to the left except: 7 purlins & 1.9" 13 gauge arches with 6" long swedge to insert into ground stake. It also comes standard with W bracing on the crossties (4 braces per crosstie). Uses 50' wide plastic

Size	Price	Optional 5 1/2' Sidewall add:
34' x 48'	\$6,850.00	\$81.00
34' x 72'	\$9,250.00	\$119.00
34' x 96'	\$11,985.00	\$156.00
34' x 144'	\$17,650.00	\$231.00



GREENHOUSE SUPPLY

NON-STOCK Greenhouse Frames, 6' arch spacing

These frames feature 2 3/8" arches and 6' arch spacing. Contact us for pricing on custom length, etc. **Prices are FOB Charles City, IA.** Extended lead times on frames likely. Prices subject to change without notice. Call to request a quote or check availability.

30' Gothic Greenhouse, 5' Straight Sides

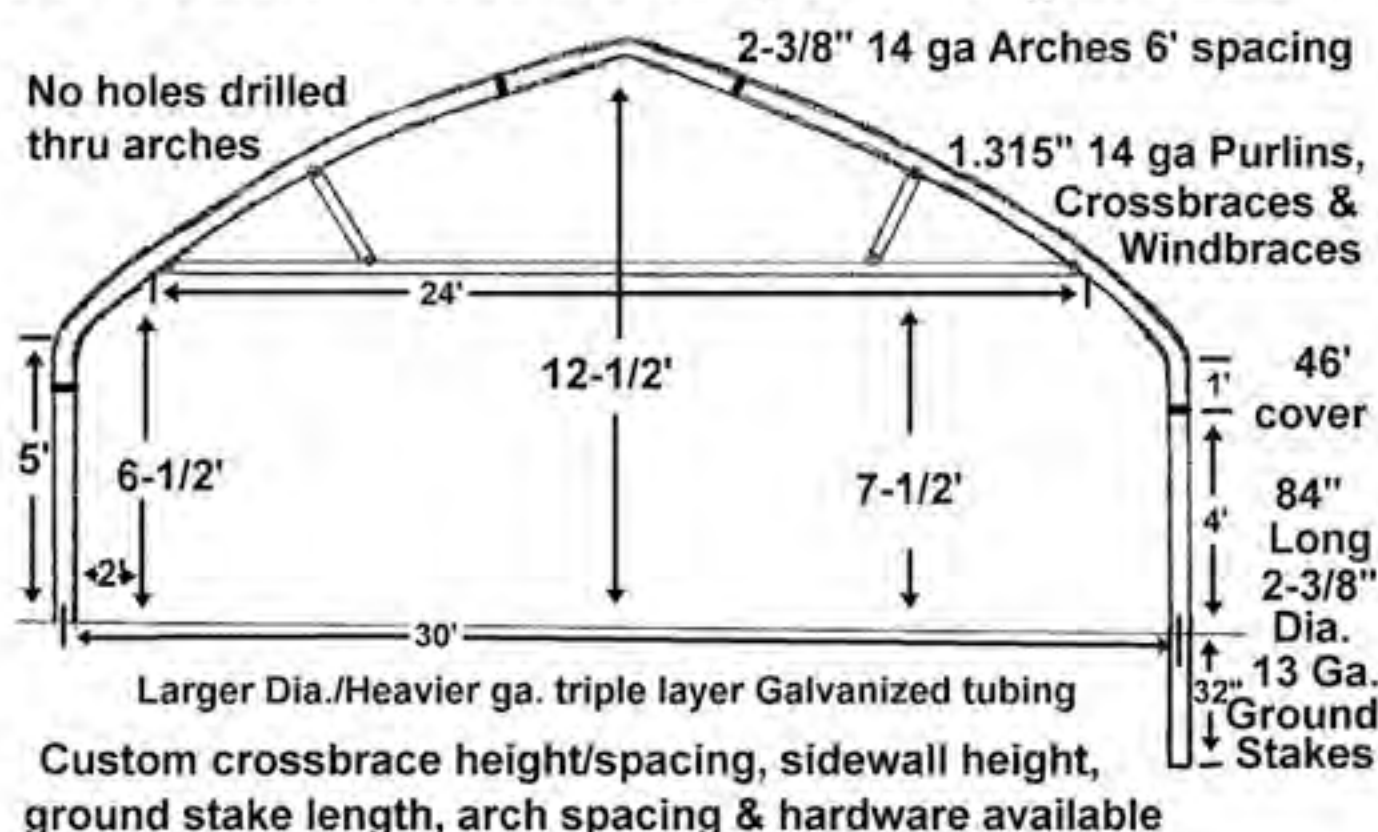

This 30' frame includes crosstie assembly on each arch except end arches, and has 5 purlins and 4 wind braces. Hardware: cross connectors & pipe straps for fastening purlins, bolts & pipe straps for baseboard, end wall brackets, assembly instructions and stake driver.

Size	Price
30' x 48'	\$3,380.00
30' x 72'	\$4,888.00
30' x 96'	\$6,240.00
30' x 144'	\$9,100.00

34' Gothic Greenhouse, 5' Straight Sides

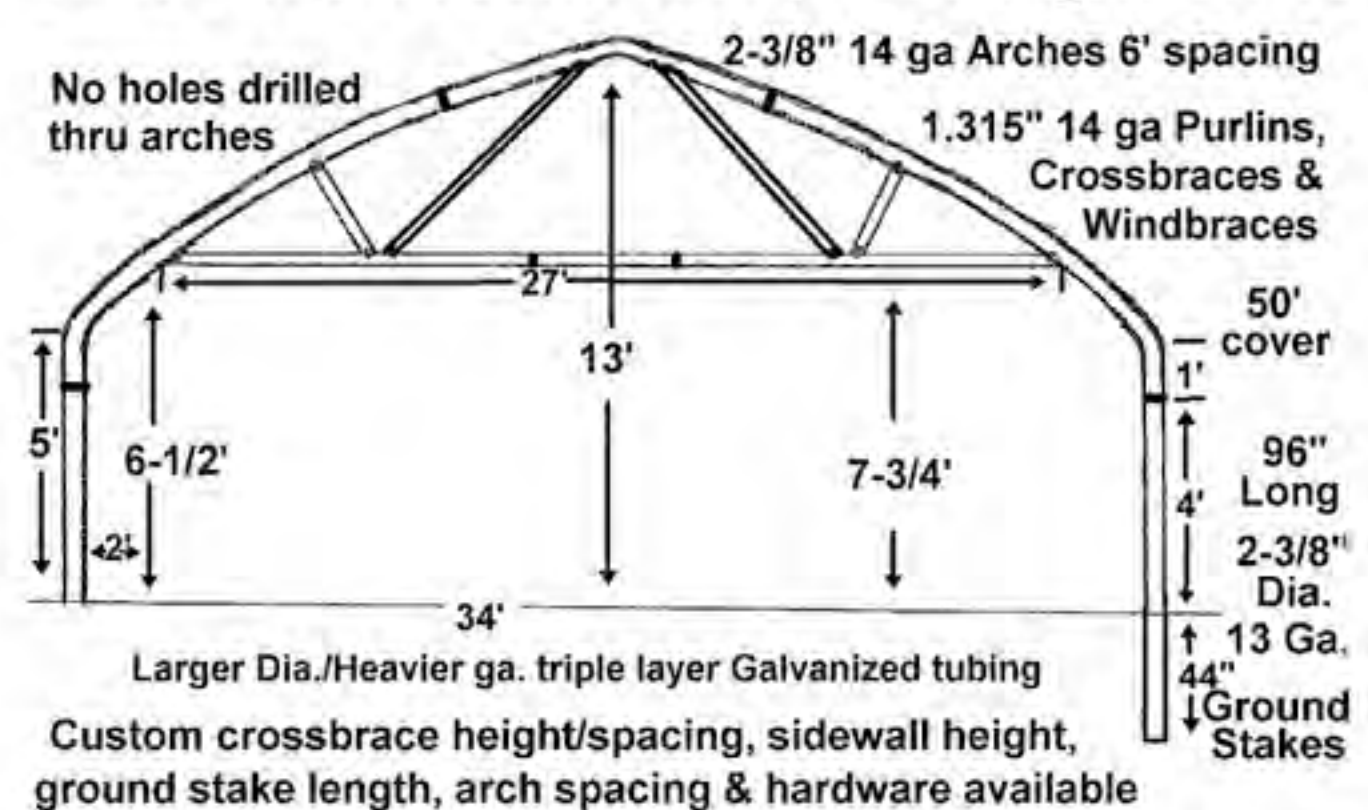

This 34' frame includes crosstie assembly on each arch except end arches, and has 7 purlins and 4 wind braces. Hardware: cross connectors & pipe straps for fastening purlins, bolts & pipe straps for baseboard, end wall brackets, assembly instructions and stake driver.

Size	Price
34' x 72'	\$6,552.00
34' x 96'	\$8,320.00
34' x 144'	\$11,960.00
34' x 198'	\$15,600.00



Greenhouse (High Tunnel) Sample Packages

These high tunnel packages include two layers of plastic, inflation blower, plastic for end walls, and two roll-up sides. Frame includes all hardware & parts required for assembly including lugs & straps to fasten baseboard and a detailed construction manual.

Some other basic items that you will need to obtain include: Doors, Treated lumber to frame end walls (2x4 and/or 4x4) and for baseboards (2x8 or 2x10). You may also need electrical wiring, propane and water plumbing.

Add-ons we stock: Roll-Lock to secure roll up pipe (recommended if heating), heaters, exhaust and circulation fans, intake shutters, black ground cover, polycarbonate twin wall sheeting, temperature alarms, purlins for hanging baskets, etc.

Call for a quote on High Tunnel Packages, other sizes are available. 508-273-7358

21' X 48'

Qty	Unit	Item #	Item Description
1	ea	C2148	21x48' Peaked Greenhouse frame
1	ea	T4636110	36x110' 6 Mil 4 year Tufflite IV Plastic
1	ea	T4614	14x100' 6 Mil 4 year Tufflite IV Plastic
1	ea	GGA500	3/4"x500 Batten Tape
1	ea	GEA0600	3 Bolt Blower KIT 60 CFM w/cord115V
1	ea	GEA0601	3Bolt Blower Mounting Kit
9	Pcs	GFA1	8' Single WireLock Base
8	Pcs	GFA1080	12' DOUBLE WireLock Base
2	100 Pcs	GFA2121	1" #12 SS Self Drilling TEK Screw
2	50/Bund	GFA104	4' ZigZag Wire
2	ea	GFAM04	GC5:1B 5:1 GearCrank w/1.315 adapter
2	ea	GFAM04P	6' Guide Pipe Asy, for 5:1 Gearcrank
12	ea	GFA5RH	Aluminum Rope Hooks
14	ea	ZES04003	4" Zinc Plated Eye Screw 5/16"
1	350' Roll	GFA5CR	1/4" Rope NeoBraid Black 100% polyester
50	ea	FC010	1" Fabric Clip, Fits 1-1/8" OD Pipe
8	ea	GGP131217S	1-3/8" 17ga 147" Swedged Purlin Pipe
1	ea	GFA5RPH2X	Roll-pipe Hanger for 2" Baseboard, 9/ PK

30' X 72'

Qty	Unit	Item #	Item Description
1	ea	C3072	30x72' Gothic Greenhouse Frame
1	ea	T4648150	48x150' 6 Mill 4 Year Tufflite IV Plastic
1	ea	T4614	14x100' 6 Mill 4 Year Tufflite IV Plastic
1	ea	GGA500	3/4"x500 Batten Tape
1	ea	GEA1480	4 Bolt Blower KIT 148 CFM w/Cord 115V
1	ea	GEA1481	4 Bolt Blower Mounting Kit
8	Pcs	GFA10	12' Single WireLock Base
12	Pcs	GFA1080	12' DOUBLE WireLock Base
2	100 Pcs	GFA2121	1" #12 SS Self Drilling TEK Screw
120	ea	GFA104	4' ZigZag Wire
2	ea	GFAM04	GC5:1B 5:1 GearCrank w/1.315 adapter
2	ea	GFAM04P	6' Guide Pipe Asy, for 5:1 Gearcrank
1	25/Pk	GFA5RH	Aluminum Rope Hooks
20	ea	ZES04003	4" Zinc Plated Eye Screw 5/16"
1	350' Roll	GFA5CR	1/4" Rope NeoBraid Black 100% polyester
74	ea	FC010	1" Fabric Clip, Fit 1-3/8" OD Pipe
12	ea	GGP131217S	1-3/8" 17 ga 147" Swedged Purlin Pipe
1	ea	GFA5RPH2X	Roll-pipe Hanger for 2" Baseboard, 9/PK

21' X 72'

Qty	Unit	Item #	Item Description
1	ea	C2172	21x72' Peaked Greenhouse frame
1	ea	T4636150	36x150' 6 Mil 4 year Tufflite IV Plastic
1	ea	T4614	14x100' 6 Mil 4 year Tufflite IV Plastic
1	ea	GGA500	3/4"x500 Batten Tape
1	ea	GEA1480	4 Bolt Blower KIT 148 CFM w/cord115V
1	ea	GEA1481	4 Bolt Blower Mounting Kit
9	Pcs	GFA1	8' Single WireLock Base
12	Pcs	GFA1080	12' DOUBLE WireLock Base
2	100 Pcs	GFA2121	1" #12 SS Self Drilling TEK Screw
2	50/Bund	GFA104	4' ZigZag Wire
2	ea	GFAM04	GC5:1B 5:1 GearCrank w/1.315 adapter
2	ea	GFAM04P	6' Guide Pipe Asy, for 5:1 Gearcrank
1	25/Pk	GFA5RH	Aluminum Rope Hooks
20	ea	ZES04003	4" Zinc Plated Eye Screw 5/16"
1	350' Roll	GFA5CR	1/4" Rope NeoBraid Black 100% polyester
74	ea	FC010	1" Fabric Clip, Fits 1-3/8" OD Pipe
12	ea	GGP131217S	1-3/8" 17ga 147" Swedged Purlin Pipe
1	ea	GFA5RPH2X	Roll-pipe Hanger for 2" Baseboard, 9/ PK

30' X 96'

Qty	Unit	Item #	Item Description
1	ea	C3096	30x96' Gothic Greenhouse Frame
1	ea	T4648	48x100' 6 Mill 4 Year Tufflite IV Plastic
1	ea	TES48	48x100' 6 Mill 4 Year Tufflite Infrared Plastic
1	ea	T4614	14x100' 6 Mill 4 Year Tufflite IV Plastic
1	ea	GGA500	3/4"x500 Batten Tape
1	ea	GEA1480	4 Bolt Blower KIT 148 CFM w/Cord 115V
1	ea	GEA1481	4 Bolt Blower Mounting Kit
8	Pcs	GFA10	12' Single WireLock Base
16	Pcs	GFA1080	12' DOUBLE WireLock Base
3	100 Pcs	GFA2121	1" #12 SS Self Drilling TEK Screw
3	50/BUND	GFA104	4' ZigZag Wire
2	ea	GFAM04	5:1 GearCrank w/1.315 adapter
2	ea	GFAM04P	6' Guide Pipe Asy, for 5:1 Gearcrank
1	25/Pk	GFA5RH	Aluminum Rope Hooks
26	ea	ZES04003	4" Zinc Plated Eye Screw 5/16"
1	350' Roll	GFA5CR	1/4" Rope NeoBraid Black 100% polyester
100	ea	FC010	1" Fabric Clip, Fit 1-3/8" OD Pipe
16	ea	GGP131217S	1-3/8" 17 ga 147" Swedged Purlin Pipe
1	ea	GFA5RPH2X	Roll-pipe Hanger for 2" Baseboard, 9/PK

21' X 96'

Qty	Unit	Item #	Item Description
1	ea	C2196	21x96' Peaked Greenhouse frame
1	ea	T4636110	36x110' 6 Mil 4 year Tufflite IV Plastic
1	ea	TES36110	36x110' 6 Mil 4 year Tufflite Infrared Plastic
1	ea	T4614	14x100' 6 Mil 4 year Tufflite IV Plastic
1	ea	GGA500	3/4"x500 Batten Tape
1	ea	GEA1480	4 Bolt Blower KIT 148 CFM w/cord115V
1	ea	GEA1481	4 Bolt Blower Mounting Kit
9	Pcs	GFA1	8' Single WireLock Base
16	Pcs	GFA1080	12' DOUBLE WireLock Base
3	100 Pcs	GFA2121	1" #12 SS Self Drilling TEK Screw
3	50/BUND	GFA104	4' ZigZag Wire
2	ea	GFAM04	GC5:1B 5:1 GearCrank w/1.315 adapter
2	ea	GFAM04P	6' Guide Pipe Asy, for 5:1 Gearcrank
1	25/Pk	GFA5RH	Aluminum Rope Hooks
26	ea	ZES04003	4" Zinc Plated Eye Screw 5/16"
1	350' Roll	GFA5CR	1/4" Rope NeoBraid Black 100% polyester
100	ea	FC010	1" Fabric Clip, Fits 1-3/8" OD Pipe
16	ea	GGP131217S	1-3/8" 17ga 147" Swedged Purlin Pipe
1	ea	GFA5RPH2X	Roll-pipe Hanger for 2" Baseboard, 9/ PK

21' Peaked High Tunnels:

- 10 1/2" to peak, 5' Straight Sidewall.
- Arches: 1.66" x 14 gauge, Stakes: 1.9" x 13 gauge.
- Purlins & windbraces: 1.315" x 17 gauge
- Crossties are optional.

30' Gothic Greenhouse (or Tunnel) Frame

Arches	1.660" x 14 ga
Stakes	1.900" x 13 ga
Crosstie	1.315" x 14 ga
Braces	1.315" x 16 ga
Purlins	1.315" x 16 ga

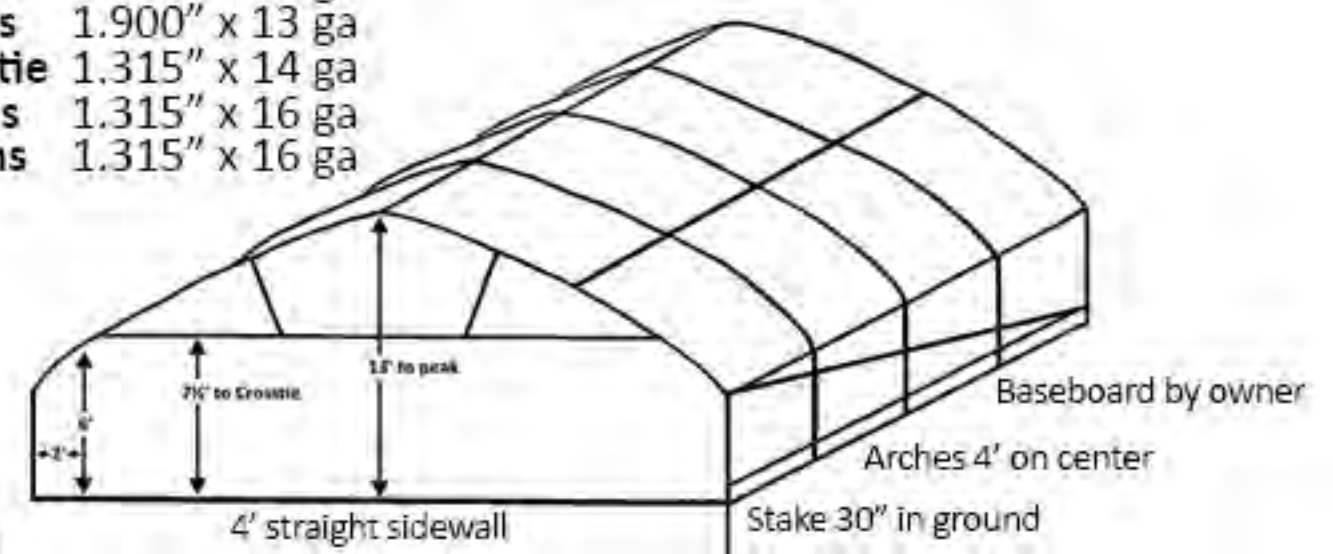

Freight Is Additional.
All prices are FOB Leola, PA

GREENHOUSE SUPPLY



NEW OASIS GROWER SOLUTIONS

We have the following in stock. Please contact us for availability of other sizes.

OASIS HORTICUBE



ITEM NO.	DESCRIPTION	SIZE	PRICE
13919	276 Count	20/CS	\$146.70

Used in hydroponic growing, Horticulture is a lower density and higher drainage foam for vegetable and herb growing.



OASIS ROOTCUBE



ITEM NO.	DESCRIPTION	SIZE	PRICE
13968	1" 162 Cell	20/CS	\$126.75

Used in hydroponics. An engineered hydrophilic foam cutting propagation medium specifically designed for optimal callus and rapid root development. Contains a starter nutrient.





L Series Packs (Inserts) Standard 1020 Size

Call for full skid pricing.

T.O. PLASTICS LANDMARK PLASTIC

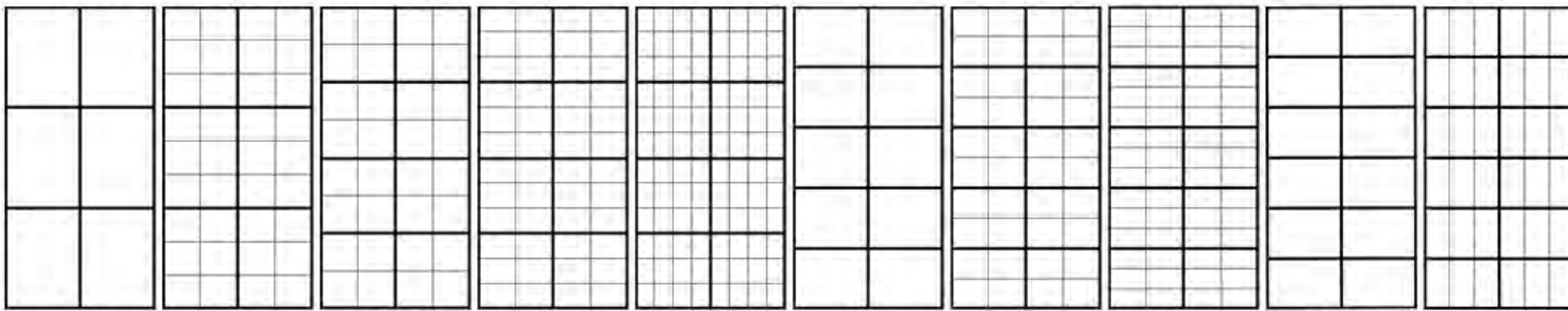

0601 0606 0804 0806 0812 1001 1004 1006 1201 1203

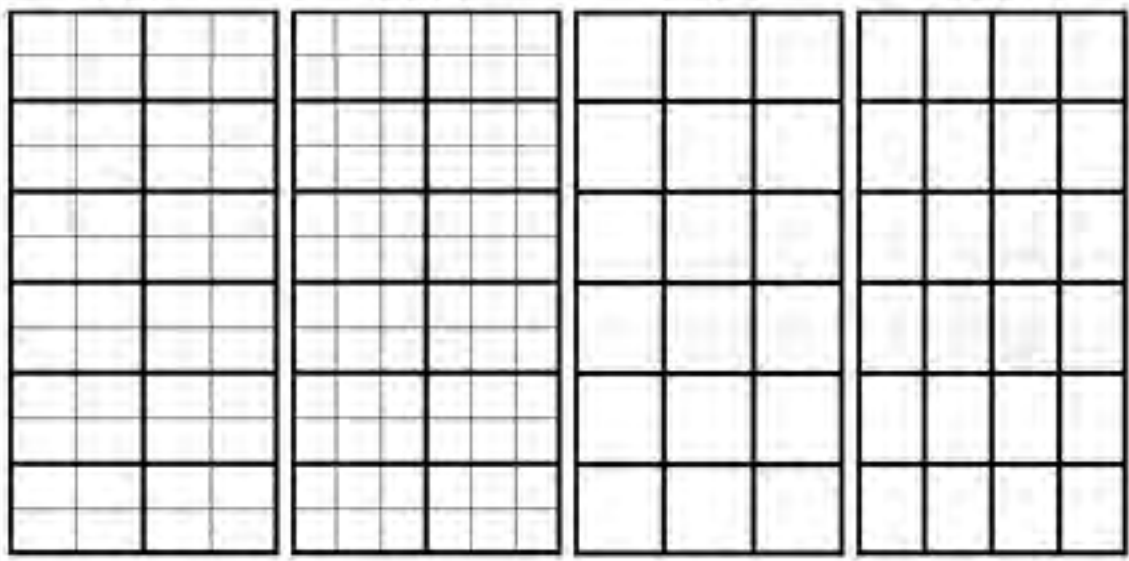

1204 1206 1801 2401

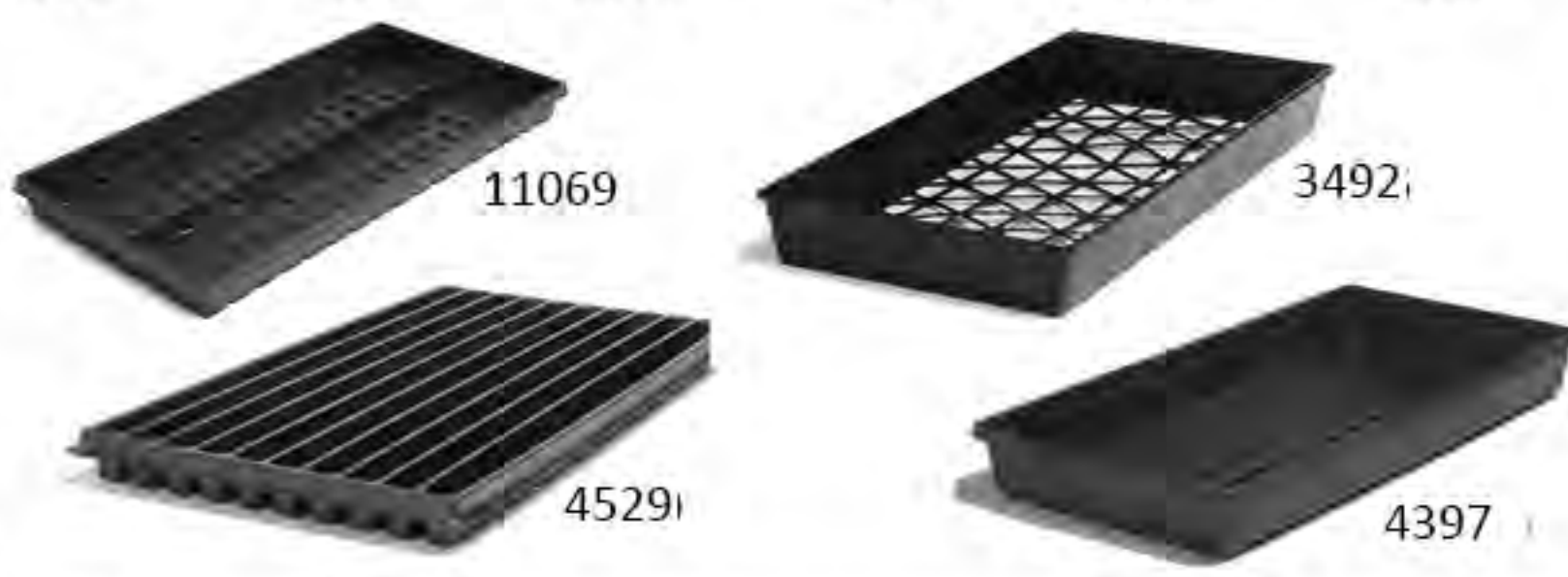

GREENHOUSE SUPPLY

L Series Packs (Inserts) Standard 1020 Size (20.85" x 10.42")					Skid Qty	Cell Dimensions			Pack Volume		
Item #	Description	Sheets/Cs	1-5 Cs	6-31 Cs		Mfg Code	Length	Width	Depth	Liquid	Cu. In.
Perforated and easy to tear apart.											
3452	601, 6 packs of 1 cell	100	\$62.50	\$61.00	ASK FOR PRICE	STI-601	6.44	4.85	2.33	1.13 qt	65.05
4207	606, 6 packs of 6 cells	100	\$61.50	\$60.00		STI-606	2.35	2.15	2.33	1.91 pt	55.10
3494	804, 8 packs of 4 cells	100	\$59.50	\$58.00		STI-804	2.35	2.35	2.33	1.48 pt	42.72
3495	806, 8 packs of 6 cells	100	\$59.50	\$58.00		STI-806	2.35	1.55	2.33	1.34 pt	38.81
10321	812, 8 packs of 12 cells	100	\$62.50	\$61.00		STI-812	1.52	1.13	2.33	-	-
11059	1001, 10 packs of 1 cell	100	\$62.50	\$61.00		STI-1001	4.80	3.85	2.33	-	-
11061	1004, 10 packs of 4 cells	100	\$61.50	\$60.00		STI-1004	2.40	1.85	2.33	1.09 pt	31.44
11062	1006, 10 packs of 6 cells	100	\$61.50	\$60.00		L1006	1.85	1.75	2.33	0.99 pt	28.63
11063	1201, 12 packs of 1 cell	100	\$62.50	\$61.00		STI-1201	4.85	3.15	2.33	1.01 pt	29.29
11064	1203, 12 packs of 3 cells	100	\$62.50	\$61.00		STI-1203	3.15	1.55	2.33	0.89 pt	25.81
10641	1204, 12 packs of 4 cells	100	\$59.50	\$58.00		STI-1204	2.35	1.45	2.33	0.87 pt	25.14
10409	1206, 12 packs of 6 cells	100	\$61.50	\$60.00		STI-1206	1.55	1.55	2.33	0.75 pt	21.60
3496	1801, 18 packs of 1 cell	100	\$61.50	\$60.00		STI-1801	3.10	3.10	2.33	0.64 pt	18.55
11065	2401, 24 packs of 1 cell	100	\$62.50	\$61.00		STI-2401	3.10	2.25	2.33	0.44 pt	12.75

L Series Super Jumbo/Deep Packs, Stnd 1020 Size (20.85" x 10.42")					Skid Qty	Cell Dimensions			Pack Volume		
Item #	Description	Sheets/Cs	1-5 Cs	6-31 Cs		Mfg Code	Length	Width	Depth	Liquid	Cu. In.
Perforated and easy to tear apart.											
4443	606, 6 packs of 6 cells	100	\$61.50	\$60.00	ASK FOR PRICE	STI606DP	2.35	2.15	3.13	1.29 qt	74.69
3451	804, 8 packs of 4 cells	100	\$63.50	\$62.00		L8045J	2.46	2.47	3.05	1.55 pt	44.44
2805	806, 8 packs of 6 cells	100	\$61.50	\$60.00		STI806DP	2.35	1.60	3.12	1.64 pt	47.27
11067	1204, 12 packs of 4 cells	100	\$63.50	\$62.00		L1204D	2.63	1.72	2.75	1.02 pt	29.41

L Series Trays, Carrying Trays and Seeder Trays (Standard 1020 size)

Item #	Description	Pcs/Cs	1-5 Cs	6-Skid	Skid Qty	Mfg Code	Length	Width	Depth
3492	Economical, Solid State, Web Bottom	50	\$47.50	\$46.25	ASK FOR PRICE	IL1020ISS	21.13	10.63	2.31
3595	Heavy Duty, Almost Solid Side, Web Bottom	50	\$53.85	\$52.75		694213	21.13	10.65	2.40
2806	NCR Tray, Solid Side with Bottom Drain Holes	100	\$80.00	\$78.00		710245C	21.22	10.80	2.33
4397	NCRN Tray, Solid Side and Bottom, NO Holes	100	\$81.00	\$79.00		710251C	21.22	10.80	2.33
11068	NCR Tray, Solid Side with Bottom Drain Holes, same as CF 22, but 50% thicker plastic	75	\$89.95	\$87.00		L1020NCR-HD	21.22	10.80	2.33
11069	Open Seeder Tray, Solid Side, Slitted Bottom	100	\$119.00	\$117.00		136ST	21.22	10.80	1.38
4529	10 Row Seeder Tray, Solid Side, Slitted Bottom	100	\$126.00	\$123.00		PSEED10	21.50	11.00	1.25

PLUG SHEETS



Plug Sheets (20.85" x 10.42") Standard 1020 Size (Lightweight, to use with a carrying tray)								Cell Configuration	Top Diameter	Cu. In. Per Cell
Item #	Description	Pcs/Cs	1-5 Cs	6-31 Cs	Skid Qty	Mfg Code	Depth			
10306	38 Round	100	\$77.00	\$75.00	ASK FOR PRICE	38PS	2.38	2@7 and 3@8	2.25	6.80
10180	50 Round	100	\$64.50	\$62.50		725602C	2.38	5 x 10	2.00	4.60
10182	72 Round	100	\$70.00	\$68.00		72PS	2.38	6 x 12	1.50	2.54
10420	98 Round	100	\$74.50	\$72.50		98PS	1.63	7 x 14	1.38	1.69
4769	18 SQUARE	100	\$65.00	\$63.00		18SPSD	3.23	3 x 6	3.16	23.42
11052	50 SQUARE	100	\$98.50	\$96.50		725616C	2.38	5 x 10	1.93	5.80
11053	72 SQ. w/Root Channels	100	\$70.00	\$68.00		72SPS	2.38	6 x 12	1.63	4.09

PLUG TRAYS



Plug Flats (21.38" x 11.05") Standard 1020 Size (Heavy-duty, to use without a carrying tray)								Cell Config.	Top Diameter	Cu. In. Per Cell
Item #	Description	Pcs/Cs	1-5 Cs	6-Skid	Skid Qty	Mfg Code	Depth			
3470	50 Square	100	\$118.50	\$116.50	24	P50	2.25	5 x 10	1.75	5.19
2950	72 Square, Deep	100	\$118.50	\$116.50	32	P72SQD	2.38	6 x 12	1.63	4.45
10307	72 Round w/Vent Holes	100	\$118.50	\$116.50	32	72FPT	2.25	6 x 12	1.49	2.52
3392	98 Square	100	\$118.50	\$116.50	32	P98	2.00	7 x 14	1.25	1.92
2881	128 Square <i>T.O. also available</i>	100	\$102.50	\$100.50	32	P128	2.00	8 x 16	1.25	1.68
10284	200 Square	100	\$106.00	\$104.50	32	P200	1.75	10 x 20	0.88	1.29
3457	288 Square	100	\$117.50	\$115.50	32	P288SQ	1.00	12 x 24	0.75	0.44
10173	288 Square, Deep	100	\$117.50	\$115.50	32	P288SQD	1.75	12 x 24	0.75	0.61
11054	392 Square	100	\$118.50	\$116.50	32	P392	1.00	14 x 28	0.63	0.28
11055	406 Square <i>While supplies last!</i>	100	\$119.85	\$117.95	32	P406	1.00	14 x 29	0.63	0.28
11056	512 Square	100	\$106.00	\$104.00	20	P512	1.00	16 x 32	0.56	0.24

Hexagon Plug Flats, Standard 1020 Size (Heavy-duty, to use without a carrying tray)								Cell Config.	Top Diameter	Cu. In. Per Cell
Item #	Description	Pcs/Cs	1-5 Cs	6-Skid	Skid Qty	Mfg Code	Depth			
11057	105 w/Root Channels	100	\$99.50	\$97.50	32	105HEX	1.5	7 x 15	1.25 x 1.38	1.4

SEEDLING TRAYS



Seedling Trays (21.23" x 10.8") Standard 1020 Size (HD, to use without carrying tray)								Cell Config.	Top Dia.	Cu. In. Per Cell
Item #	Description	Pcs/Cs	1-5 Cs	6-Skid	Skid Qty	Mfg Code	Depth			
4768	30 Ct Rose pot shape w/ channels	50	\$84.50	\$82.50	32	30ST	3.50	2@8 & 2@7	2.50	10.50
3493	38 Ct Rose pot shape w/ channels	50	\$102.00	\$100.00	20	38ST	5.00	3@8 & 2@7	2.25	12.10
10423	50 Ct Octagonal w/ round bottom	55	\$107.00	\$105.00	20	50ST	4.50	5 x 10	1.88	8.80
13354	72 Ct Rose pot shape w/ channels	50	\$78.00	\$76.00	32	72ST	3.25	6 x 12	1.63	4.20

Square Pots



Press Fit, Landmark Plastics		Stock color: Black					Dimensions		Volume		Compatible
Item #	Description	Pcs/Cs	1-5 Cs	6-Skid	Skid Qty	Mfg Code	Dia.	Depth	Liquid	Cu. In.	Transport Trays
4770	2.25 Square	1,920	\$83.50	\$82.50	36	225P	2.19	3.00	0.306 pt	8.85	4771
3438	3.00 Square	800	\$39.00	\$38.00	52	3PF800	2.63	2.25	0.375 pt	10.8	3439
3534	3.00 Square Deep	800	\$39.00	\$38.00	48	3PD800	2.63	3.50	0.59 pt	17.09	3439
11254	3.25 Sq. Extra Deep	400	\$30.00	\$29.00	72	3PXD400	3.00	4.25	0.83 pt	23.98	11259
4766	4.00 Square	450	\$39.00	\$38.00	48	SVD 350	3.50	3.50	1.05 pt	30.33	3394
4912	4.00 Sq. Extra Deep	450	\$51.50	\$50.50	32	4PXD	3.50	5.02	1.52 pt	43.94	3394
3497	4.50 Square	375	\$42.00	\$41.00	28	45P375	4.19	3.63	1.69 pt	48.82	4446,11260,3523
3440	4.50 Square Deep	375	\$49.00	\$48.00	28	45PD375	4.19	4.88	1.15 qt	66.64	4446,11260,3523

Black w/Label Slots, Belden Plastics							Dimensions		Volume		Compatible
Item #	Description	Pcs/Cs	1-5 Cs	6-Skid	Skid Qty	Mfg Code	Dia.	Depth	Liquid	Cu. In.	Transport Trays
11255	4.50 Jumbo Jr Square	375	\$98.00	\$97.00	28	691525	4.13	5.00	1.05 qt	N/A	4446,11260,3523
11256	5.25 Jumbo Square	200	\$98.00	\$97.00	40	6915150	5.25	5.25	1.71 qt	N/A	Trays page 55
11257	5.25 Jumbo Senior	200	\$98.00	\$97.00	40	691535	5.25	6.50	2.03 qt	N/A	Trays page 55
11258	6.00 Magnum Square	150	\$94.00	\$93.00	40	691543	6.00	6.50	2.79 qt	N/A	11262

Sheet of Pots

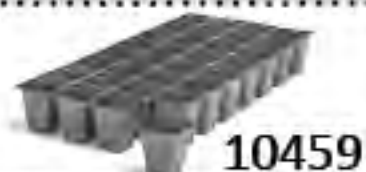

Lightweight pots in a perforated sheet, Landmark Plastics							Dimensions		Volume		Compatible
Item #	Description	Pcs/Cs	1-5 Cs	6-Skid	Skid Qty	Mfg Code	Diameter	Depth	Liquid	Cu. In.	Transport Trays
10459	3.00 Square, 32 Count	100	\$78.50	\$77.00	24	3SQSP	2.45 x 2.47	3.00	0.387 pt	11.17	10552
4209	3.50 Sq. Deep, 18 Ct	100	\$85.00	\$84.00	20	35SPXD	3.48 x 3.47	3.50	0.92 pt	26.55	3394, trays pg 55
4445	4.50 Square, 15 Count	100	\$122.00	\$121.00	16	45SP	4.09 x 4.09	3.65	1.55 pt	44.85	4446

Square Pot Trays



Square Pot Trays							Dimensions			Compatible
Item #	Description	Pcs/cs	1-5 Cs	6-Skid	Skid Qty	Mfg Code	Length	Width	Depth	Square Pots
4771	2.25 Sq. Pot Tray, 32 Count	100	\$82.00	\$81.00	40	2SPT32	18.10	9.12	2.25	4770
3439	3.00 Sq. Pot Tray, 32 Count	100	\$91.00	\$90.00	32	LPF32TRY	21.23	10.79	1.50	3438
10552	3.00 Sheet of Pots Tray, 32 Ct	100	\$89.00	\$88.00	32	3SPT32	21.23	10.79	2.00	10459
11259	3.25 Sq. Extra Deep Tray, 20 Ct	100	\$116.00	\$115.00	36	3PXD20	15.19	12.19	2.00	11254
PF 1040	4.00 Sq. Pot Tray, 18 Count	50	\$43.50	\$42.50	24	SPT 350	21.23	10.79	2.31	4766,4912,4445
4446	4.50 Sq. Pot Tray, 15 Count	50	\$56.00	\$55.00	32	LPF15TRY	21.10	12.71	2.31	3497,3440,11255,4209
11260	4.50 Sq. Pot Tray, 12 Count	100	\$96.00	\$95.00	20	L45PF12	16.97	12.75	2.31	3497,3440,11255
3523	4.50 Sq. Pot Tray, 10 Count	90	\$69.00	\$68.00	30	455PJ10	20.94	8.44	2.02	3497,3440,11255
11261	Jumbo Sq. Pot Tray, 8 Count	50	\$169.00	\$168.00	18	While supplies last!	21.25	10.90	3.25	While supplies last!
11262	Magnum Sq. Pot Tray, 6 Count	50	\$161.50	\$160.50	18	694225	18.00	12.00	3.25	11258

Water-Matic Trays

Reservoir holds water while elevated overflow holes ensure that excess water is drained.



Item #	Description	Pcs/cs	1-5 Cs	6-Skid	Mfg Code	Length	Width	Depth	Compatible Pots
11263	4.50 Square Tray, 15 ct 3x5	50	\$75.00	\$74.00	While supplies last!	21.05	12.61	2.44	3497,3440,11255
11264	4.50 Rnd/Sq, 8 Ct 2x4 spaced	100	\$173.00	\$172.00	45RSWM	20.25	10.13	2.44	All Square and Round 4.5"



Round Thermoformed Pots

2799



13136



3436



3434



11265



11266



Flexible sidewall with rim design that has good hoop strength.

Item #	Description	Pcs/Cs	Price				Mfg Code	Dimensions		Volume		Compatible Trays
			1-5 Cs	6-Skid	Skid Qty			Dia.	Depth	Liquid	Cu. In.	
15313	4.33 Round, Black	765	\$75.00	\$74.00		43RMGT	4.33"	3.90	1.25 pt	3.60	15314	
2799	4.00 Round, Black	825	\$69.50	\$68.00	42	4RMGT	4.0"	3.49	1.02 pt	29.4	2802	
4578	4.50 Geranium, Black	450	\$49.75	\$48.25	48	4RMGT	4.5"	4.02	1.37 pt	39.7	2803, 11275	
13136	4.50 Geranium, Terra-Cotta	450	\$72.50	\$71.00	48	45RMGT	4.5"	4.02	1.37 pt	39.7	2803, 11275	
3436	5.00 Azalea, Black	440	\$55.00	\$53.50	48	5AMGT	5.0"	3.61	1.67 pt	48.21	3435	
14790	5.00 Azalea, Terra-Cotta	440	\$82.00	\$79.50	48	5AMGT	5.0"	3.61	1.67 pt	48.21	3435	
3434	6.00 Azalea, Black	220	\$43.00	\$41.50	48	6AMGT	6.0"	4.38	1.40 qt	81.04	3442	
80-0180	6.00 Azalea, Terra-Cotta	220	\$57.00	\$55.50	48	6AMGT	6.0"	4.38	1.40 qt	81.04	3442	
14791	6.50 Azalea, Black	240	\$47.00	\$45.50	48	65AMGT	6.5"	5.00	2.08 qt	120.12	13355	
12511	6.50 Azalea, Terra-Cotta	240	\$72.00	\$70.50	48	65AMGT	6.5"	5.00	2.08 qt	120.12	13355	
11266	7.50 Azalea, Black	220	\$69.00	\$67.50	220	75AMGT	7.5"	5.71	3.02qt	174.5		

Round Injection Molded Pots

11268



4208



11269



KOBA

AZALEA
POTS



Heavy Duty, Rigid

Item #	Description	Pcs/Cs	Price				Mfg Code	Dimensions		Volume		Compatible Trays
			1-5 Cs	6-Skid	Skid Qty			Dia.	Depth	Liquid	Cu. In.	
11267	Clay 3.00 Standard	1,750	\$174.25	\$172.50	28	Koba	3"	2.75	7.0 fl oz	12.63	11274	
11268	Black 4.50 Azalea	750	\$119.75	\$118.25	28	Koba	4.5"	3.63	1.28 pt	37.90	11275, 2803	
4349	Green 4.50 Azalea	750	\$120.95	\$119.25	28	Koba	4.5"	3.63	1.28 pt	37.90	11275, 2803	
4208	Black 6.00 Azalea	252	\$85.00	\$84.00	48	IA600MP	6"	4.75	1.57 qt	90.80	3442	
12984	Green 6.00 Azalea	252	\$86.50	\$85.00	48	IA600MP	6"	4.75	1.57 qt	90.80	3442	
11269	Black 6.50 Azalea	246	\$78.50	\$77.00	28	Koba	6.5"	5.13	2.00 qt	115.52	13355	
11047	Green 6.50 Azalea	246	\$79.00	\$77.50	28	Koba	6.5"	5.13	2.00 qt	115.52	13355	
11270	Green 7.00 Azalea	264	\$126.95	\$124.50	28	Koba	7"	5.50	2.16 qt	151.62		
11271	Green 8.00 Azalea	206	\$119.95	\$118.50	18	Koba	8"	6.25	1.00 gal	231.04		
11272	Green 10.00 Azalea	36	\$41.95	\$41.00	40	Koba	10"	7.50	1.75 gal	404.32		
11273	Black 12.00 Azalea	25	\$81.95	\$81.00	42	Belden	12"	9.00	3.00 gal	0.00		

Round Pot Transport Trays

2802



11275



3442



Item #	Description	Pcs/cs	Price Per Case				Mfg Code	Dimensions			Compatible Pots
			1-5 Cs	6-Skid	Skid Qty			Length	Width	Depth	
11274	3.00 12 Count 3x4	146	\$219.75	\$216.50		Koba	12.00	9.00	3.00	11267	
2802-100	4.00 15 Count 3x5	100	\$122.95	\$120.25	14	4TP15PS	20.25	12.13	3.50	2799	
11275	4.50 12 Count 3x4	75	\$98.75	\$96.00	24	45TP10	18.99	14.11	3.96	4578, 11268, 4349	
2803	4.50 15 Count 3x5	90	\$171.95	\$164.75	16	45TPPP	23.06	14.06	3.94	4578, 11268, 4349	
3435	5.00 8 Count 2x4	100	\$127.95	\$126.50	36	T5TP	20.00	10.00	3.75	3436, 14790	
3442	6.00 6 Count 2x3	100	\$147.50	\$145.85	30	6TP	17.64	11.50	4.25	3434, 80-0180, 4208, 12984	
13355	6.50 6 Count 2x3	100	\$153.50	\$151.25	28	65TP	19.63	13.00	5.25	4791, 12511, 11209, 11047	

Mum Pans

3437



11280



3453



13356



Thermoformed has a flexible sidewall with rim design that has good hoop strength							Dimensions		Volume	
Item #	Description	Pcs/Cs	1-5 Cs	6-Skid	Skid Qty	Mfg Code	Dia.	Depth	Liquid	Cu. In.
13378	8.00 Black, Thermoformed	130	\$47.95	\$47.00	30	8MPMGT	8.0	5.0	3.04 qt	175.44
11278	8.00 Terra-Cotta, Thermoformed	130	\$62.95	\$62.00	30	8MPMGT	8.0	5.0	3.04 qt	175.44
11280	8.00 Green, Injection Molded	258	\$255.00	\$249.00	25	IMP800	8.0	5.0	3.09 qt	178.49
11276/14816	9.00 Black, Thermoformed	140	\$59.00	\$58.00	25	9MPMGT	9.0	5.9	1.18 gal	271.9
3453/14691	9.00 Terra-Cotta, Thermoformed	140	\$79.00	\$78.00	25	9MPMGT	9.0	5.9	1.18 gal	271.9
11277/14692	9.00 Green, Thermoformed	140	\$79.00	\$78.00	25	9MPMGT	9.0	5.9	1.18 gal	271.9
13356	10\"/>									
13357	10\"/>									

WHITE PLASTIC LABELS & SIGNS



Item #	Description	Price
4299	4-1/2" x 1" (1,000/roll – perforated)	\$20.75
3395	4" x 5/8" (1,000/box – loose)	\$26.75
4300	5" x 5/8" (1,000/box – loose)	\$29.25
13358	7" x 5/8" loop tag (1,000/roll – perforated)	\$31.75
11195	3" x 5" Angled T-sign, 10 3/4" height, 50/cs	\$32.00
11196	2-1/2" x 4" Angled T-sign, 16" height, 50/cs	\$34.50
11197	4" x 6 1/4" Angled T-sign, 20 1/4" height, 25/cs	\$36.00
11198	Base for all angled T-signs, 25/cs	\$48.95
13988	2 1/4" X 3 3/4" Flat t-signs, 10"h, 100/cs	\$39.00

Gro-Pot – Woven Planter Bag

Made with green 4.13 oz./Sq. Yd. UV stabilized woven cloth. Each pot has 2 sewn handles. Sold in packs of 25 pcs or bales of 100 pcs.



Item #	Description	Each	100/Pack
11528	9 Gallon, 14" x 14"	\$2.25	\$186.50
11529	12 Gallon, 15" x 15.75"	\$2.25	\$198.50
11530	15 Gallon, 16.5" x 17.75"	\$2.50	\$222.50

Liquid Chalk

Use with T-signs. Will not wash off from rain or general watering but it can be removed with a moist paper towel. Older writing (ghosting) can be cleaned with an alcohol based hand sanitizer.



Item #	Description	Price
11199	Liquid Chalk Markers, 3pk-Red, Green, Blue	\$18.49

Permanent Markers

Garden Marker: Fast drying, waterproof pen that contain filters for maximum fade resistance. Alcohol-based ink. Xylene free.
Sharpie® Marker: Fine point permanent marker.



Item #	Description	Price	Quantity	Price
10442	Black Garden Marker	\$2.29	25+	\$2.00
10197	Black Sharpie Marker	\$15.00	for 12 pack	



Nursery Containers, Thermoformed

11281



11283



11204



11286



11290



LANDMARK PLASTIC
HAVILAND
PLASTIC PRODUCTS

Flexible sidewall with rim design that has good hoop strength.

Item #	Description	Pcs/Cs	Price Per Case				Mfg Code	Dimensions		Volume		Compatible Trays
			1-5 Cs	6-Skid	Skid Qty	Dia.		Depth	Liquid	Cu. In.		
11281	True Quart, 4.75" Black	600	\$87.75	\$83.75	24	TQTMGT	4.75	5.27	1.02 qt	59.10	11297	
10341	Trade Gallon, 6.5" Black	200	\$42.65	\$41.55	48	65NTGT	6.50	6.50	2.50 qt	144.00	11298	
11284-170	True Gallon, 8" Black	~170	\$77.85	\$76.95	70	HP-100	8.00	6.87	1.00 gal	231.00		
11286	Trade 2 Gallon, 8.5" Black	100	\$57.50	\$56.50	24	85NT2G	8.50	9.00	1.50 gal	346.20		
11288-150	Trade 2 Gallon, 9" Black	150	\$94.75	\$92.65	54	HP-175	9.00	8.50	1.50 gal	346.00		
11289-140	True 2 Gallon, 9.75" Black	~140	\$98.00	\$97.00	46	HP-200	9.75	9.12	2.00 gal	462.00		
11290-120	True 3 Gallon, 11" Black	120	\$118.75	\$116.00	36	HP-300	11.00	9.69	3.00 gal	693.00		
13359	Trade 4 Gallon, 12.2" Black	55	ASK		48	HP-500	12.22	11.63	4.02 gal	924.00		

Nursery Containers, Injection Molded

11291



11293



11294



11295



Heavy Duty, Rigid			Price Per Case				Dimensions			Volume		Compatible Trays
Item #	Description	Pcs/Cs	1-5 Cs	6-Skid	Skid Qty	Mfg Code	Dia.	Depth	Liquid	Cu. In.		
11291	Black 300 Trade Gallon	68	\$49.75	\$49.25	42	INCTGAL	6.13	6.87	2.64 qt	152.06	11299	
11292	Terra-Cotta 300 Trade Gal	68	\$54.00	\$53.00	42	INCTGAL	6.13	6.87	2.64 qt	152.06	11299	
11293	Black 400 True Gallon	75	\$90.00	\$88.00	30	INCSGAL	7.15	7.00	1.01 gal	232.38		
11294	Black 600 Trade 2 Gallon	65	\$96.50	\$95.00	29	INCT2GAL	8.04	8.50	1.47 gal	339.17		
3535	Terra-Cotta 600 Trade 2 Gal	65	\$98.00	\$97.25	29	INCT2GAL	8.04	8.50	1.47 gal	339.17		
11295	Black 1000 Trade 3 Gallon	59	\$148.60	\$146.00	16	INCT3GAL	10.41	9.50	2.79 gal	644.41		

Nursery Container, Transport Trays



11297



11298



11299

Nursery Container Carrying Trays			Price Per Case				Dimensions			Compatible Pots
Item #	Description	Pcs/cs	1-5 Cs	6-Skid	Skid Qty	Mfg Code	Length	Width	Depth	
11297	4.75" True Quart, 8 Count	75	\$89.00	\$88.00	36	QTTWL8	19.50	10.00	5.30	
11298	6.50" Trade Gallon, 6 Count	50	\$79.00	\$78.00	42	TGOF6	19.63	13.00	6.71	
11299	300 Trade Gallon, 6 Count	50	\$62.00	\$61.00	28	3QTCT	19.50	12.75	2.50	

Nursery Container, HPP Blow Molded

4482



11304



11307



HAVILAND
PLASTIC PRODUCTS

Black flexible pots with rounded top rim that has multiple handle grips.

Item #	Description	Pcs/Cs	Price Per Case			Mfg Code	Dimensions		Volume	
			1-5 Cs	6-Skid	Skid Qty		Dia.	Depth	Liquid	Cu. In.
13140	5 Gal, 500 Squat Series		CALL FOR PRICE and AVAILABILITY				14.00	10.00	5.00 gal	1,155
13138	6 Gallon, 700 Series		CALL FOR PRICE and AVAILABILITY				14.00	11.50	6.08 gal	1,405
Item #	Pots below sold by the piece	1-99	100-Ski	Skid Qty+	Skid Qty	Dia.	Depth	Liquid	Cu. In.	
11304	10-1/2 Gallon, 1000 Series	\$5.75	\$5.65	\$5.50	560	16.50	14.75	10.67 gal	2,465	
11305	13-1/2 Gallon, 1500 Series	\$5.75	\$5.65	\$5.50	480	18.20	16.00	13.66 gal	3,155	
11306	20 Gallon, 2000 Series	\$8.75	\$8.50	\$8.35	260	20.00	17.00	20.04 gal	4,629	
11307	27-1/2 Gallon, 2500 Series	\$8.75	\$8.50	\$8.35	300	24.00	18.00	27.50 gal	6,353	

GREENHOUSE SUPPLY



Hanging Baskets

LANDMARK PLASTIC



3458



11308



10232



11310

DILLEN-ITML
The HC Companies

Hanging Baskets, Landmark Plastics			Price per case				Dimensions		Volume		Compatible Hangers
Item #	Description Saucerless = Inside Saucer	Pcs/ Cs	1-5 Cs	6-Skid	Skid Qty	Mfg Code	Dia.	Depth	Liquid Gal.	Cu. In.	
4211	White 10" Imperial Deco, Saucerless	50	\$67.50	\$66.00	50	IH10	10	6.5	1.5	346.5	4364/4810/10324
4210	Green 10" Imperial Deco, Saucerless	50	\$64.50	\$63.50	50	IH10	10	6.5	1.5	346.5	4171/4170/10324
11308	Choc. Brown 10" Imperial, Saucerless	50	\$64.50	\$63.50	50	IH10	10	6.5	1.5	346.5	4444/10324
3458	White 10" Contempo Swirl, Saucerless	50	\$62.75	\$61.75	50	ICT10	9.88	6	1.28	295.05	4364/4810/10324
3459	Green 10" Contempo Swirl, Saucerless	50	\$63.75	\$62.75	50	ICT10	9.88	6	1.28	295.05	4171/4170/10324
15316	Black 10" Contempo Swirl, Saucerless	50	\$67.75	\$66.75	50	ICT10	9.88	6	1.28	295.05	4171/4170/10324

SEE 11" SIZE BELOW

Hanging Baskets, ITML			Price per case				Dimensions		Volume		Compatible Hangers
Item #	Description Saucerless = Inside Saucer	Pcs/ Cs	1-5 Cs	6-Skid	Skid Qty	Mfg Code	Dia.	Depth	Liquid Gal.	Cu. In.	
11310	White 11" Traditional, Saucerless	50	\$83.00	\$82.00	40	HTS11000	11	7	1.75	400	3460/4364/10324
11311/15315	Green 11" Traditional, Saucerless	50	\$84.00	\$83.00	40	HTS11000	11	7	1.75	400	3461/4171/10324

Hanging Baskets, Landmark Plastics			Price per case				Dimensions		Volume		Compatible Hangers
Item #	Description Saucerless = Inside Saucer	Pcs/ Cs	1-5 Cs	6-Skid	Skid Qty	Mfg Code	Dia.	Depth	Liquid Gal.	Cu. In.	
12849	White 12" Deco Swirl, Saucerless	25	\$63.75	\$62.75	48	IDS12	11.81	7.22	2.25	520.23	10267/11312
10232	Green 12" Deco Swirl, Saucerless	25	\$63.75	\$62.75	48	IDS12	11.81	7.22	2.25	520.23	12030/11312
14792	Black 12" Deco Swirl, Saucerless	25	\$63.75	\$62.75	48	IDS12	11.81	7.22	2.25	520.23	14793/11312

Hangers, for Baskets

Item #	Description	Pcs/Pk	Price		Qty Disc		Mfg Code	Type	Compatible Baskets
			Per Pack	Qty Disc	Price				
4364	White 16" Plastic, 3 Strand	25	\$8.50	18+	\$8.25		I16ACL	Double Clip	4211/3458/11310
4171	Green 16" Plastic, 3 Strand	25	\$8.75	18+	\$8.50		I16ACL	Double Clip	4210/3459/11311
4810	White 19" Plastic, 3 Strand	25	\$9.75	18+	\$9.50		I19SPCL	Snap Clip	4211/3458/11311
4170	Green 19" Plastic, 3 Strand	25	\$10.50	18+	\$10.25		I19SPCL	Snap Clip	4210/3459
4444	Choc. Brown 19" Plastic, 3 Strd	25	\$10.75	18+	\$10.50		I19SPCL	Snap Clip	11308
3461	Green 18.75" Plastic, 3 Strand	25	\$12.95	20+	\$12.75	While Supplies Last.		Double Clip	11311
10267	White 22" Plastic, 4 Strand	25	\$8.20	20+	\$8.00		K22ACL	Double Clip	10266
12030	Green 22" Plastic, 4 Strand	25	\$8.50	20+	\$8.25		K22ACL	Double Clip	10232
14793	Black 22" Plastic, 4 Strand	25	\$8.50	20+	\$8.25		K22ACL	Double Clip	14792
10324	21" Wire 3 Strand, Galvanized	50	\$13.00	10+	\$12.75		Z21LH50	Wrapped Wire	4211/3458/11310
11312	24" Wire 4 Strand, Galvanized	50	\$16.25	5+	\$16.00		Z24164STW	Wrapped Wire	10266

GREENHOUSE SUPPLY



Hanging Baskets, KOBA

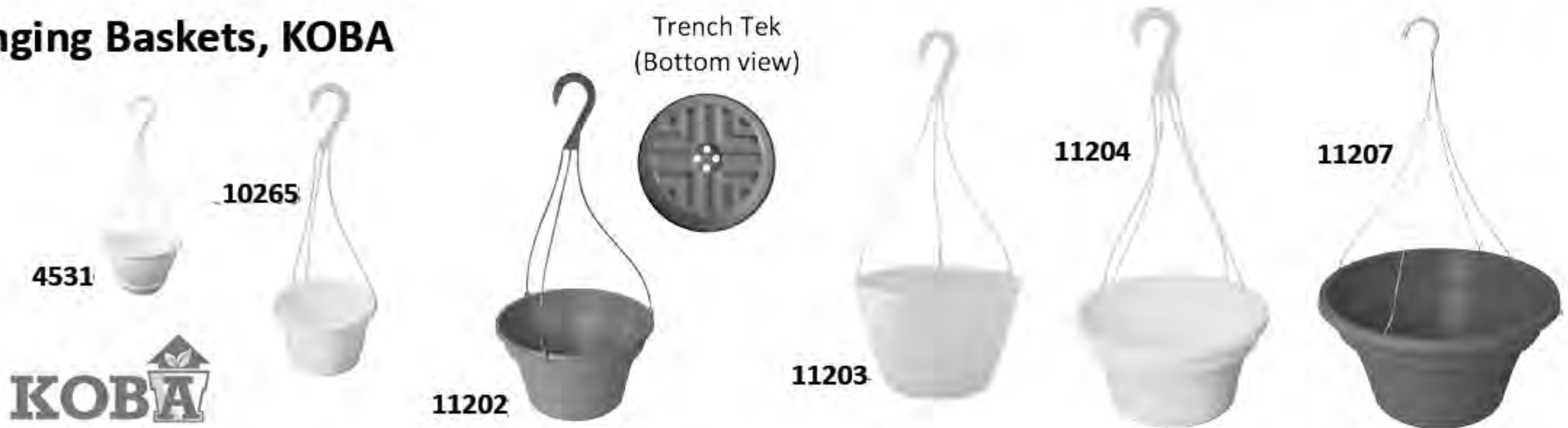

Item #	Description Saucerless = Inside Saucer	Pcs/Cs	Price per case			Hangers (Included)	Dimensions		Volume	
			1-5 Cs	6-Skid	Skid Qty		Dia.	Depth	Liquid	Cu. In.
15317	White 4.5" Traditional w/ Snap-on Saucer	132	\$106.95	\$104.50	18	12", 3 Strand	4.5	4.38	1.60 gal	46.93
4531	White 6" Traditional w/Snap-on Saucer	84	\$155.00	\$153.65	27	12" 3 Strand	6.0	4.13	1.16 qt	68.59
10265	White 8" Fluted, Saucerless	84	\$93.75	\$92.65	50	17" 3 Strand	8.0	5.13	0.70 gal	162.4
4531	White 6" Traditional w/Snap-on Saucer	84	\$155.00	\$153.65	27	12" 3 Strand	6.0	4.13	1.16 qt	68.59
10265	White 8" Fluted, Saucerless	84	\$93.75	\$92.65	50	17" 3 Strand	8.0	5.13	0.70 gal	162.4
15318	Green 8" Fluted, Saucerless	84	\$96.50	\$94.00	50	17", 3 Strand	8.0	5.13	0.70 gal	162.4
11201	White 10.5" Trench Tek	96	\$99.00	\$98.00	40	17", 3 Strand	10.5	6.00	1.25 gal	288.6
11202	Tera-Cotta 10.5" Trench Tek	96	\$100.00	\$99.00	40	17", 3 Strand	10.5	6.00	1.25 gal	288.6
11203	White 11" Traditional, Trench Tek	50	\$53.15	\$99.00	32	19", 3 Strand	11	6.38	1.73 gal	400.2
11266	Green 11" Traditional, Trench Tek	50	\$54.50	\$53.00	32	19", 3 Strand	11	6.38	1.73 gal	400.2
14794	Black 11" Traditional, Trench Tek	50	\$54.50	\$53.00	32	19", 3 Strand	11	6.38	1.73 gal	400.2
Trench Tek Hanging Baskets. Base design eliminates need for inside saucer resulting in less labor and cost.										
11204	White 12" Curved, Saucerless	50	\$110.00	\$109.00	24	22" 4 Strand	12.0	7.25	2.37 gal	548.7
12581	Terra-cotta 12" Curved, Saucerless	50	\$114.00	\$113.00	24	22" 4 Strand	12.0	7.25	2.37 gal	548.7
15319	Green 12" Curved, Saucerless	50	\$115.00	\$114.00	24	22", 4 Strand	12.0	7.25	2.37 gal	548.7
11206	White 14" Curved, Saucerless	60	\$197.25	\$195.65	27	26" 4 Str Wire	14.0	7.75	3.04 gal	703.7
11207	Terra-cotta 14" Curved, Saucerless	60	\$199.25	\$197.65	27	26" 4 Str Wire	14.0	7.75	3.04 gal	703.7

**We do carry a variety of traditional hanging baskets.
Please ask.**

Jiffy-7® – Peat Pellets

This pellet with a soft pre-formed center is held together by fine netting, ensuring optimum air/water exchange, and is filled with high-quality substrate and then compressed to form a handy pellet. Just add water, and the pellet grows to up to seven times its size. Pellet diameter: 42mm.

Item #	Description	Quantity	1-5 Cases	6+ Cases
4297	Jiffy-7® Peat Pellets	1,000/box	\$85.00	\$83.00



Jiffystrips®

These peat pots are 100% biodegradable and come in strips that fit in standard 1020 trays (see page 8) and can be torn into individual pots for easy planting.



4317	#525 fits 32 pots/Std. 1020 tray	2.50"	8	2304	\$135.00	6+	\$133.00
4714	#516 fits 50 pots/Std. 1020 tray	1.75"	10	5100	\$179.00	6+	\$176.00
11212	#519 fits 72 pots/Std. 1020 tray	1.50"	12	5040	\$250.00	6+	\$247.00



LANDMARK PLASTIC



KHAN SATURN POTS, Round			Price per case			Mfg Code	Dimensions		Volume	
Item #	Description	Pcs/Cs	1-5 Cs	6-Skid	Skid Qty		Dia.	Depth	Liquid	Cu. In.
3455	10" Terra-Cotta	50	\$79.00	\$77.00	40	KSAT10	11.48	7.86	2.05 gal	473.6
4380	12" Terra-Cotta	40	\$98.75	\$94.50	30	KSAT12	13.45	9.27	3.45 gal	797.3
3599	14" Terra-Cotta	30	\$140.00	\$137.00	16	KSAT14	15.87	11.19	5.76 gal	1330.6
14796	14" Fluted, Terra-Cotta	30	\$87.00	\$85.00	16	KFPN14	14.25	9.50	3.62 gal	836.6

HICKORY BARREL (Wood look), Round			Price per case			Mfg Code	Dimensions		Volume	
Item #	Description	Pcs/Cs	1-5 Cs	6-Skid	Skid Qty		Dia.	Depth	Liquid	Cu. In.
14203	10.5" Chocolate Brown	80	\$105.00	\$102.00	32	KCT270	10.50	7.50	1.83 gal	422
14797	13" Chocolate Brown	40	\$96.85	\$94.65	36	KCT340	13.00	9.60	3.5 gal	805
14798	14.5" Chocolate Brown	30	\$99.00	\$96.90	36	KCT380	14.50	10.50	4.5 gal	1036

2 Piece SPARTA URN			Price per case			Mfg Code	Dimensions		Volume	
Item #	Description	Pcs/Cs	1-5 Cs	6-Skid	Skid Qty		Dia.	Depth	Liquid	Cu. In.
11217	12" White Urn	25	\$85.00	\$84.00	48	KCZ305	11.8	11.6	1.6 gal	374
11218	12" Black Urn	25	\$73.00	\$70.00	48	KCZ305	11.8	11.6	1.6 gal	37

Botanica Series, Large Round			Price per case			Mfg Code	Dimensions		Volume	
Item #	Description	Pcs/Cs	1-5 Cs	6-Skid	Skid Qty		Dia.	Depth	Liquid	Cu. In.
11219	17.75" Tan, Vineyard	15	\$145.00	\$143.00	18	KCFP18	17.75	13.75	8.10 gal	1,886
11220	17.75" Bronze, Vineyard	15	\$155.00	\$153.00	18	KCFP18	17.75	13.75	8.10 gal	1,886
11221	17.5" Bronze, Prestige	20	\$158.00	\$156.00	18	ETA March '22	17.50	14.25	7.85 gal	1,814



TREASURE BOWLS			Price per case			Mfg Code	Dimensions		Volume	
Item #	Description	Pcs/Cs	1-5 Cs	6-Skid	Skid Qty		Dia.	Depth	Liquid	Cu. In.
4381	12" Terra-Cotta	50	\$72.95	\$71.65	48	KTSB12	12	5.67	1.55 gal	359.1
11222	12" Choc. Brown	50	\$72.95	\$71.65	48	KTSB12	12	5.67	1.55 gal	359.1
3456	14" Terra-Cotta	50	\$111.15	\$109.55	36	KTSB14	14	5.75	2.09 gal	482.1

SERENE SQUARES			Price per case			Mfg Code	Dimensions		Volume	
Item #	Description	Pcs/Cs	1-5 Cs	6-Skid	Skid Qty		Dia.	Depth	Liquid	Cu. In.
11223	7.50" Tan	100	\$92.50	\$90.00	60	KSMSQ75	7.50	7.25	1.11 gal	256.7
14078	11.50" Terra-Cotta	25	\$64.75	\$63.85	48	KSMQ115	11.50	10.00	3.50 gal	807.5

OVALS, Terra-Cotta			Price per case			Mfg Code	Dimensions		Volume	
Item #	Description	Pcs/Cs	1-5 Cs	6-Skid	Skid Qty		Dia.	Depth	Liquid	Cu. In.
11225	12" Panterra, ITML	50	\$133.00	\$130.00	64	PAP1200	13x6.5	5.00	0.97 gal	223.0
3454	16" Khan Fluted	50	\$105.00	\$104.00	36	KOVL16	16x6.75	6.00	1.82 gal	419.5
3588	Saucer for 16" Oval	50	\$44.00	\$43.00	72	KOVSL16	14.6x5.7	1.00	-	-

PLANTER BOX, Rectangular			Price per case			Mfg Code	Dimensions		Volume	
Item #	Description	Pcs/Cs	1-5 Cs	6-Skid	Skid Qty		Dia.	Depth	Liquid	Cu. In.
11226	7x14" Terra-Cotta	100	\$198.25	\$192.55	36	X714PB	7x14	4.19	1.36 gal	315.19

Decorative Planters

KOBA

11234



11233



11231



11229



DECK POTS, Round (Made in USA)			Price per case			Mfg Code	Dimensions		Volume	
Item #	Description	Pcs/Cs	1-5 Cs	6-Skid	Skid Qty		Dia.	Depth	Liquid	Cu. In.
11227	8" Terra-cotta, Trench Tek	150	\$108.65	\$107.15	18	KOBA	8.00	6.00	0.8 gal	184.79
11228	10" Terra-cotta, Trench Tek	70	\$85.25	\$84.35	32	KOBA	10.00	7.50	1.8 gal	425.9
11229	12" Terra-cotta	48	\$89.75	\$88.65	24	KOBA	12.00	9.00	3.5 gal	808.6
11230	14" Terra-cotta	20	\$67.85	\$66.25	27	KOBA	14.00	11.75	5.5 gal	1270.7

CURVE DECK POTS, Round (Made in USA)			Price per case			Mfg Code	Dimensions		Volume	
Item #	Description	Pcs/Cs	1-5 Cs	6-Skid	Skid Qty		Dia.	Depth	Liquid	Cu. In.
11232	16" Slate color	18	\$87.85	\$86.25	18	KOBA	16.00	12.2	16 gal	1418.8
14096	20" Terra-Cotta Color	Per Pc	\$9.85	\$9.60	100 Pcs	KOBA	20.00	15.5	13.5 gal	3118.8
14097	20" Honeysuckle Color	Per Pc	\$9.85	\$9.60	100 Pcs	KOBA	25.00	15.5	21.31 gal	3118.8
CALL	16" Honeysuckle Color	Bulk Skid available and 20" Slate available.								

Cut Flower Bucket

Solid base allowing for top-heavy blooms.			Price per case			Mfg Code	Dimensions		Volume	
Item #	Description	Pcs/Cs	1-5 Cs	6-Skid	Skid Qty		Dia.	Depth	Liquid	Cu. In.
11233	10" Black, no holes	30	\$47.00	\$46.00	40	KOBA	10.00	9	2.25 gal	519.8

Grow Pans *Compatible hangers optimize greenhouse growing space.*

Trench Tek bottom conserves water.			Price per case			Compatible Hangers	Dimensions		Volume	
Item #	Description	Pcs/Cs	1-5 Cs	6-Skid	Skid Qty		Dia.	Depth	Liquid	Cu. In.
11234	8" Green Deko Pan	246	\$168.45	\$166.00	18	SHBE10G, LG, W10	8.00	4	0.525 gal	125
11235	10" Green Deko Pan	130	\$122.35	\$119.75	40	SHBE10G, LG, W10	10.00	4.5	1.05 gal	248
11236	12" Green Deko Pan	116	\$168.45	\$166.00	24	SHBE12G, SHBW12	12.00	5	1.56 gal	365

Currugated Retail Flats *Self-Locking. No stapling required! Same size as standard 1020 flats.*

Item #	Description	Bundle/75pcs	Bundle/750pcs	Skid/1500pcs	Length	Width	Depth
11238	Carry Out Tray	\$44.25	\$390.00	\$760.00	21.25	10.50	2.50



True Series Inserts & Trays *True 10" x 12" size (These are NOT standard size.)*

For illustrations of pack layout see page 8						Mfg Code	Cell Dimensions			Pack Volume	
Item #	Description	Pcs/Cs	1-5 Cs	6-35 Cs	36 Cs		Length	Width	Depth	Liquid	Cu. In.
3431	T 804 Pack	100	\$57.50	\$56.00		T804	2.28	2.24	2.61	1.52 pt	44.00
4377	T 806 Pack	100	\$57.50	\$56.00		T806	2.28	1.50	2.61	1.42 pt	40.90
80-0195	T 1204 Pack	100	\$57.50	\$56.00	Ask	T1204	2.25	1.45	2.61	0.94 pt	27.16
4378	T 1206 Pack	100	\$57.50	\$56.00	for	T1206	1.45	1.44	2.61	0.81 pt	23.40
11661	T 606 Super Jumbo Pack	100	\$59.50	\$58.00	price	T606SJ	2.21	2.03	3.25	1.14 qt	65.54
3432	T 1801 Sheet of Pots	100	\$78.00	\$76.35		T1801SP	3.14	3.18	3.27	0.78 pt	22.58
3433	T Web Bottom Carrying Tray	100	\$74.65	\$73.55		ITIM	20.00	10.00	2.63		

Market Packs & Handles



11253 & 11252

3 of these fit per CFT1 tray (see above)						Cell Dimensions			Pack Volume		
Item #	Description	Pcs/Cs	1-5 Cs	6-Skid	Skid Qty	Mfg Code	Length	Width	Depth	Liquid	Cu. In.
11252	306 Pack, T Pot 6 Count	300	\$92.50	\$91.50	32	TPP6	10.11	6.73	3.5	0.72 pt	20.75
11253	19" White Handle	300	\$78.75	\$77.75	-	19SEH	19	1	-	-	-



11240 (basket)
11242 (hanger)



11246 (basket)
11251 (hanger)



11247 (basket)
11242 (hanger)



11248 (basket)
11250 (hanger)



11247 (basket)
11249 (stand)



11248 (basket)



12501 (basket)
11251 (hanger)

Coco Fiber Nest Baskets, Black Wire			Price per case			Mfg Code	Depth	Volume
Item #	Description	Pcs/Cs	1-5 Cs	6-Skid	Skid Qty			
11239	12" Coco Fiber Nest Basket	12	\$112.45	\$112.00	36	400-J12CO	6.5"	2.13 gal
11240	14" Coco Fiber Nest Basket	12	\$122.00	\$120.00	45	400-J14CO	7.0"	3.13 gal
11241	16" Coco Fiber Nest Basket	12	\$146.50	\$145.00	30	400-J16CO	7.0"	4.25 gal
Black Wire Hangers for all above Baskets								
11242	22" 3 Strand, Open Hook Hanger	12	\$36.00	\$35.00	30	400-HK22PN		
Pre-formed Replacement Coco Nest Liners								
11243	12" Coco Replacement Liner	12	\$36.00	\$34.00	36	401-L12		
11244	14" Coco Replacement Liner	12	\$45.00	\$43.00	36	401-L14		
11245	16" Coco Replacement Liner	12	\$57.00	\$56.00	36	401-L16		
Decorative Baskets, Natural Bark and Wicker with Plastic Liner								
Item #	Description	Pcs/Cs	1-5 Cs	6-Skid	Skid Qty	Mfg Code	Depth	Volume
11246	14" Flat Bark Basket	12	\$128.00	\$127.00	24	750-61	6.0"	2.00 gal
11247	14" Cone Bark Basket	12	\$128.00	\$127.00	24	750-62	15.0"	2.25 gal
11248	14" Cone Wicker & Rice Basket	12	\$122.00	\$120.00	24	750-12	15.0"	2.25 gal
12500	14" Cone Green Rope & Twig Basket	12	\$132.00	\$130.00	24	750-36	15.0"	2.25 gal
12501	14" Cone Black & Tan Rope Basket	12	\$140.00	\$139.00	24	750-70	15.0"	2.25 gal
11249	Wire stand for Cone Baskets	30	\$79.00	\$78.00	12	780-VAL	-	-
Galvanized Hangers for all above Baskets								
11250	22" 3 Strand, Galvanized WIRE Hanger	12	\$14.75	\$14.25	24	400-HK22		
11251	22" 3 Strand, Galvanized CHAIN Hanger	12	\$41.00	\$40.00	24	400-CH22		

\$131.95

GREENHOUSE SUPPLY

WATER BREAKERS

High quality Dramm® water breakers are made from impact resistant ABS plastic with a stainless steel face plate.



Item #	Description	Spray Pattern	Price
4664	RedHead	Soft, High Flow, Medium Pattern	\$11.50
10257	OrangeHead	Soft, High Flow, Wide Pattern	\$11.95
4901	LemonHead	Soft, Medium Flow	\$11.50
10258	Blue	Full Flow for drenching, hanging baskets, etc.	\$ 8.75

DRAMM® HANDI-REACH HANDLES

Standard garden hose connections.



Item #	Description	Price
12502	16" Handi-Reach Handle, 45° and 90° angle	\$8.89
4671	24" Handi-Reach Handle, 45° angle	\$9.50
4665	36" Handi-Reach Handle, 45° angle	\$10.75
10259	48" Handi-Reach Handle, 45° angle	\$11.95
10260	36" Handi-Reach Handle, 90° angle for hanging baskets, etc.	\$11.95

WONDER WATER



This high quality watering wand comes complete with filter and shutoff. The laser-cut faceplate creates a very uniform soft water pattern. It comes highly recommended by our plug growers.

Item #	Description	Price	12+
4577	Wonder Waterer	\$30.50	\$24.00
10235	Replacement Face Plate	\$6.75	\$6.50
10270	Replacement Filter Screen	\$4.50	\$4.00
11159	Filter Case only	\$6.95	\$6.50

FOGG-IT NOZZLE

These fine volume misting nozzle are a great aid in watering cuttings, delicate stock and hand misting. All bronze.



Item #	Description	Price
11160	FOGG-IT nozzle, 1 gpm	\$9.95
11161	FOGG-IT nozzle, 2 gpm	\$9.95

DRAMM® REVOLVER SPRAY GUN *Other Nozzles Available. PLEASE CALL.*

This heavy-duty spray nozzle has nine spray patterns which can easily be changed with the quick-click pattern changing Ergonomic insulated grip.

Item #	Description	Price
11162	Dramm® Revolver	\$11.95



DRAMM® COLORSTORM™ HOSE

Dramm ColorStorm-Professional Rubber Hose is made from EPDM rubber for a "crackless" hose cover that is resistant to abrasion and weathering. Heavy, hex shape that resists kinking.



Pre-assembled, with crimped nickel-plated ends:

Item #	Description	Price
11163	ColorStorm Hose 3/4" x 50'	\$106.75
11164	ColorStorm Hose 3/4" x 75'	\$139.00
10440	ColorStorm Hose 3/4" x 100'	\$169.95
11165	ColorStorm Hose 5/8" x 50'	\$69.95
11166	ColorStorm Hose 5/8" x 75'	\$106.75
11167	ColorStorm Hose 5/8" x 100'	\$121.95

Bulk Hose (cut to any length):

Item #	Description	Per Foot	Price
11168	3/4" Yellow	\$1.50	
11169	ColorStorm Hose	330' Bulk Roll	\$422.25
11170	Female Crimped Hose End		\$9.00
11171	Male Crimped Hose End		\$8.95

These nickel-plated ends are installed at our vendor. You can also use 10205 (\$4.5/set) & 2=SS Hose clamps (14038).

5/8" Crimped Hose End Also Available.

CONTRACTOR/FARM 3/4" KINK FREE HOSE



ITEM	SIZE	PRICE
3510	3/4" x 50'	\$85.39
4069	3/4" x 75'	\$96.95

High performance lead-free brass couplings, drinking water safe, phthalate Safe. Kink free Duraflow technology. High performance burst - 600 psi.

DRAMM® SYPHONJECT

Fertilize while you water. Garden hose connection Average dilution rate is 20:1. Requires 35 psi at faucet and 3-5 gpm flow. Full flow water breaker included (170PL).



Item #	Description	Price
11173	Dramm® Syphonject™ Siphon Mixer	\$15.00

FLOWER POUCHES

Green plastic with loop handle. Growing in flower pouch utilizes wall space and adds appeal.

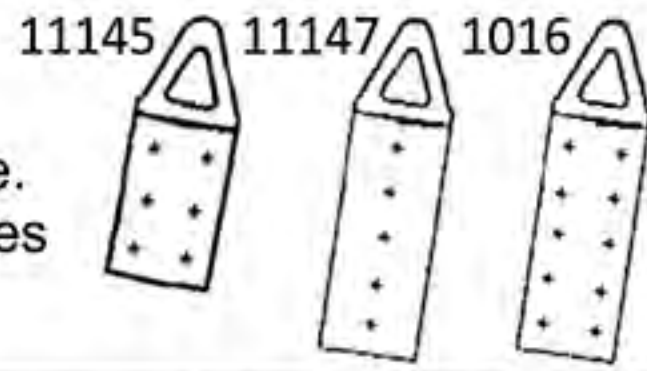

Item #	Description	Size	Volume	1-249	250+
11145	6 Slit, Al's Mini	8.5 x 13.5"	1.06 gal.	\$0.75	\$0.69
11147	5 Slit, Al's	8.5 x 21.25"	1.59 gal.	\$0.75	\$0.69
10165	10 Slit, Al's	8.5 x 21.25"	1.59 gal.	\$0.75	\$0.69
11148	8 Slit, Generation 2	8 x 20"	1.06 gal.	\$0.74	\$0.68



INSECT MONITORING CARDS

Durable, long-lasting pest monitoring and trapping cards are designed to catch a variety of pests. Non-sticky edges.

Item #	Description	Price
4532	3" x 5" Yellow Sticky Traps, 48/pack	\$27.95

HUMIDITY DOMES

Clear plastic propagation domes. Fits standard 1020 size trays



Item #	Description	5 pk	50 pk
12562/3601	Standard Domes, 21 1/4" x 11" 2 1/2'	\$7.95	\$72.50
	Below Domes Have Vents	1-39	40+
14683	Mid Height Domes	\$2.95	\$2.75
11156/14684	Tall Domes, 21.25" x 11" x 7"	\$4.15	\$3.90

AGRITAPE HEAT MAT SYSTEMS



An Agritape system consists of a control unit to regulate soil temperature, the Agritape Heat Mat, and a grounding screen. The screen serves to safely ground the current if the tape is damaged.

To install a system, roll out the Heat Mat and plug it into the control unit. Cover the Heat Mat with the ground screen. Connect the ground wire from the control unit to the screen. Plug in the control unit and place the sensor in the soil of the seed tray or container. Set to the desired soil temperature. Agritape will warm soil temperature by a maximum of 20°F (more with a humidity dome) above room temperature.

Does not work with GFCI outlets.

Electric current flows through black bars (which are a resistive/ conductive material) to create a virtually continuous heat pattern.



CONTROL UNITS:

Multi-outlet power strips can be used to add mats to a controller, however, DO NOT exceed amp rating or max amp of tape.

Item #	Description	Price
11150	Digital Control, 1 outlet, digital thermostat. Max: 50 sq. ft. of heat mats. Rated 8.5 amps.	\$78.95
4330	AT-JR Control, 2 outlets, dial thermostat. Max: 80 sq. ft. of heat mats. Rated 13 amps.	\$145.75
10454	AT-1 Control, 4 outlets, dial thermostat. Max: 120 sq. ft. of heat mats. Rated 20 amps.	\$159.95

HEAT MATS

Stock sizes (Grounding screen included).

Item #	Description	Price
4668	11" x 4' Agritape Heat Mat	\$42.95
4327	11" x 10' Agritape Heat Mat	\$73.95
4328	22" x 10' Agritape Heat Mat	\$136.95
11155	44" x 8' Agritape Heat Mat	\$179.50

HEAT MATS

Non Stock: Shipping charge may incur.

Item #	Description	Price
10452	11" Agritape - Custom Length (1-9 ft.)	\$9.00/ft.
11151	11" Agritape - Custom Length (10-25 ft.)	\$7.50/ft.
10453	Grounding Screen (for custom mats) 1- 6 ft. wide, any length.	\$1.30/per sq. Ft.
11152	22" x 4' Agritape Heat Mat	\$77.95
11153	22" x 8' Agritape Heat Mat	\$113.95
14799	44" x 4' Agritape Heat Mat	\$136.95



GREEN-SHIELD® DISINFECTANT

Disinfectant & Algicide a biodegradable liquid concentrate for horticultural use that controls fungal, bacterial, viral plant pathogens and algae.

Corrosive
No UPS shipping!



Item #	Description	Price	4+
2715	Green Shield® Disinfectant, 1 gallon	\$58.95	\$57.45

We are always adding to our inventory. Please call if you don't see what you need.

ROOTING COMPOUND



ITEM #	DESCRIPTION	PRICE
3405	Hormodin 1, 1 LB	\$33.95
13591	Hormodin 2, 1 LB	\$39.95
13592	Hormodin 3, 0.5 LB	\$30.95

Hormodin 1 is for roses, home, garden and greenhouse plants.
Hormodin 2 is for woody and semi-woody plants.
Hormodin 3 is for evergreens and dormant leafless cuttings.

CAMELOT 0



ITEM	SIZE	PRICE
10881	1 Gallon	\$168.75

Best used in greenhouse vegetables and herb cops. It's a fungicide and bactericide that prevents a wide range of bacterias from developing and spreading.
OMRI certified.

CEASE



ITEM	SIZE	PRICE
11925	1 Gallon	\$76.50

Cease is a contact biological fungicide containing a patented strain of the bacterium *Bacillus subtilis*.
OMRI listed.

EAGLE 20EW, 1 PT



ITEM NO.	PRICE
15123	\$42.75

Specialty fungicide provides excellent control of a wide variety of lawn and turf diseases including dollar spot and brown patch and is labeled for use on major turf varieties, landscape ornamentals, and backyard fruit trees and vines.

MARATHON 1%, 5 LB BAG



ITEM NO.	PRICE
2872	\$76.95

Marathon 1% G is a highly-active insecticide that demonstrates systematic activity in plants when applied to the soil surface or incorporated into the media. It offers up to 12 weeks of residual control on ornamental plants grown in the greenhouse or nursery.



PYRUS TR, 2 OZ CAN

ITEM NO.	PRICE
13866	\$22.50

Broad-spectrum control of unwanted insects for delicate ornamentals, cut flowers, evergreens and greenhouse plants. Active Ingredients: Pyrethrins and Piperonyl Butoxide



ASCERTAIN TR, 2 OZ CAN

ITEM NO.	PRICE
13867	\$22.00

Protects bedding plants, containerized plants, cut flowers, ornamentals, and other non-food crops in greenhouses from pests.
Active Ingredient: Bifenthrin



PISTON TR, 2 OZ CAN

ITEM NO.	PRICE
13868	\$22.00

A total release formula that provides a broad-spectrum control of mites, thrips and fungus gnats in greenhouses. Active ingredient: Chlorfenapyr



SEE PAGE 15 FOR SOLUBLE FERTILIZER OPTIONS.



sungro[®]

HORTICULTURE

Our Expertise is Growing[®]

Developed by professional horticulturists and produced under the industry's highest quality standards, we offer over 100 professional and retail products.



horticultural growing media leader

SOIL



METRO MIX

ITEM	DESCRIPTION	SIZE	UNITS PER PALLET	PRICE
11646	MM830-F3B RSi	2.8 cfl	48	\$18.95
15351	MM830-F3B RSi	60 cfl	2	CALL
12816	MM852-F52 RSi	2.8 cfl	42	\$18.95
15353	MM852-F52 RSi	60 cfl	2	CALL
12971	MM865 RSi	2.8 cfl	40	\$19.95

SUNSHINE MIX

ITEM	DESCRIPTION	SIZE	UNITS PER PALLET	PRICE
12884	Sunshine Mix #1-F1P Rsi	2.8 cfl	54	\$17.95
12839	Sunshine Mix #1-F1P Rsi	3.8 cfc	30	\$28.95
15347	Sunshine Mix #1 N&O Rsi + EWC (OMRI)	2.8 cfl	51	CALL
12886	Sunshine Mix #5 RSi	2.8 cfl	54	\$19.59
12882	Sunshine Mix #5 RSi	3.8 cfc	30	\$31.95
12883	Sunshine Mix #15-F15 Rsi	2.8 cfl	54	\$15.95
12881	Sunshine Mix #15-F15 Rsi	3.8 cfc	30	\$27.95

SUNSHINE #4

ITEM	DESCRIPTION	SIZE	UNITS PER PALLET	PRICE
14942	Sunshine Mix #4 with RSi	2.8 cfl	54	\$22.25
15348	Sunshine Mix #4 with RSi	3.8 cfc	30	CALL
15349	Sunshine Advanced Mix #4 (OMRI)	30 cfc	30	CALL

ATTENTION GROWERS:

Do you sell direct to consumer?
Are you based in Southeastern Mass?

If so, make sure your free SEMAP Local Food Guide listing is up to date.

Update your farm's information at:
www.semaponline.org/guide

Based in another area of Mass?
Find your buy local initiative at:
www.localfoodma.org

Best wishes on a fruitful season,
Southeastern Massachusetts
Agricultural Partnership



BLACK GOLD FAFARD RETAIL PRODUCTS

ITEM	DESCRIPTION	SIZE	UNITS PER PALLET	PRICE
15350	Black Gold All Purpose Potting Soil w/ CRF	1 cfl	70	CALL
13911	Black Gold All Purpose Potting Soil w/ CRF	2 cfl	40	\$13.95
14941	Black Gold Natural & Organic Potting Mix	1cfl	70	\$8.95
14940	Black Gold Natural & Organic Potting Mix	2 cfl	40	\$15.95
13875	Fafard Natural & Organic Potting Soil	1 cfl	70	\$8.95
13366	Fafard Ultra Outdoor Planting Mix	1 cfl	70	\$10.95

CALL FOR PALLET OR TRUCKLOAD DISCOUNTS

Due to the volatility in the soil industry, prices and availability may change without notice.

BERGER BM2 SEED GERMINATION



ITEM	DESCRIPTION	PRICE
2750	3 cu ft, loose	\$14.95



General purpose high-quality plug mix for unmatched uniformity during seed germination and seedling production. Optimized aeration and water retention, reduced weight for increased volume per shipment.

BERGER BM6 HP

ITEM	DESCRIPTION	PRICE
15219	3.8 cu ft, bale	\$27.95



This high perlite version of BM6 is designed to provide superior aeration and drainage. This is a general use mix.

BERGER BM4 - SOILESS W\WOOD FIBER

ITEM	DESCRIPTION	PRICE
2751	3.8 cu ft, bale	\$26.95



A blend of Canadian sphagnum peat moss and eco-friendly NF Wood, this matrix of fibers creates a unique connective network offering high water retention and ample air space for rapid root development. Great for containers.

BERGER BM7 COARSE BARK



ITEM	DESCRIPTION	PRICE
2879	3.0 cu ft, loose	\$26.95
3006	3.8 cu ft, bale, COARSE	\$29.75

The regular BM7 is an all-purpose bark mix providing additional weight and a balanced air to water ration. The COARSE bark mix is a combination of Canadian Sphagnum peat moss, coarse bark and perlite creating ideal aeration and porosity - all while providing additional weight for anchor. Both are well adapted for medium to large containers when extra weight is required.

BERGER BM8

ITEM	DESCRIPTION	PRICE
4214	3.8 cu ft, bale	\$28.95

This mix is specifically designed to lengthen the dry-down period. The extra water reserve is great for maintaining moisture level in hanging baskets and large containers. For use in multiple greenhouse crops from medium to large containers.

BERGER BM6 GENERAL PURPOSE (PERLITE ONLY)



ITEM	DESCRIPTION	PRICE
2880	3 cu ft, loose	\$12.50
2593	3.8 cu ft, bale	\$21.95

The classic peat perlite growing media manufactured exclusively with superior ingredients under stringent quality control specifications. Provides good drainage, maintains a moderate water content between irrigations, and contains carefully sieved horticultural perlite.

VERMICULITE AND PERLITE

ITEM	DESCRIPTION	WEIGHT	SIZE	PRICE
10334	VERMICULITE #3A FINE	20 LBS	4 cu ft	CALL
13335	VERMICULITE #A2 FINE	23 LBS	6 cu ft	CALL
2869	VERMICULITE #D3 FINE	23 LBS	6 cu ft	CALL
14277	VERMICULITE #2A MEDIUM	20 LBS	4 cu ft	CALL
2868	VERMICULITE #3A MEDIUM	23 LBS	6 cu ft	CALL
2922	VERMICULITE #A4 COARSE	23 LBS	6 cu ft	CALL

ITEM	DESCRIPTION	WEIGHT	SIZE	PRICE
13413	PERLITE MEDIUM	15 LBS	4 cu ft	CALL
15088	PERLITE COARSE	25 LBS	4 cu ft	CALL
2867	PERLITE SUPER COARSE	23 LBS	6 cu ft	CALL

Rice Hulls an OMRI Listed, a multiple use amendment to greenhoused nurseries. It's a perfect replacement for perlite and is less dusty. It also significantly improves weed control when used as a top dress.

Vermiculite improves soil aeration while retaining the moisture and nutrients necessary to feed roots, cuttings, and seeds for faster growth. Vermiculite possesses cation exchange properties, it can hold and make available to the growing plant ammonium, potassium, calcium and magnesium. It is lightweight and easy to handle and mixes well with soil, peat, composted pine bark and other composted organic materials, fertilizers, pesticides, and herbicides.

Perlite is a volcanic mineral which expands from four to twenty times its original volume. When expanded, each granular, snow white particle of perlite is sterile with a neutral pH and contains many tiny, closed cells or bubbles. The surface of each particle is covered with tiny cavities which provide an extremely large surface area. These surfaces hold moisture and nutrients and make them available to plant roots. Perlite is sterile, it is free of disease, seeds, and insects.

Due to the availability of PERLITE and VERMICULITE, inventory stock may fluctuate. ORDER EARLY!



Although we would love to have all Vermont Compost products in stock, our inventory is driven by popularity. We are able to get any VC product with enough advance notice, up to two month's preferably.

SOMETIMES FULL PALLET MINIMUM APPLIES.

VERMONT COMPOST SCREENED MANURE COMPOST

ITEM	SIZE	PRICE
10227	20 QUARTS	\$10.95
11638	2 YARD SLING	\$545.00

This compost blend is approved for use on certified organic farms and is the basis of all of the soil mixes at Vermont Compost. Premium compost comprised of carefully sourced, high-quality ingredients: a fully mature composted blend of bovine, equine, and avian manures, hardwood bark, late cut hay, spoiled silage, animal bedding, food residuals.

VERMONT COMPOST PERRENIAL BLEND

ITEM	SIZE	PRICE
4358	2 YARD SLING	\$759.00

This blend is formulated for organic growing, in large pot, container, and bed culture where course texture is preferred. Recommended if you need to fill a raised bed.

Coast of Maine...

COAST OF MAINE STONINGTON BLEND-GROWER'S MIX



ITEM	SIZE	PRICE
15340	1.5 CF Great option for retail!	\$27.50
15341	60 CF Sack	\$1045.00



15340 An OMRI listed platinum grower's mix. High performance, grow clean potting mix, for large container plants. Enriched with compost, lobster, kelp & fish bone meals, worm castings and mycorrhizae. Natural slow released nitrogen.

COAST OF MAINE BAR HARBOR-POTTING SOIL

ITEM	SIZE	PRICE
15342	60 CF Sack	\$465.00

An OMRI listed potting soil for house plants, flowers, vegetables, herbs and all container gardens. Enriched with compost, lobster meal and kelp meal. Natural slow released nitrogen.

COAST OF MAINE CASTINE-RAISED BED MIX

ITEM	SIZE	PRICE
15343	60 CF Sack	\$395.00

An OMRI listed raised bed mix. Ready-to-use for growing vegetables, herbs and flowers. Enriched with compost, lobster & kelp meals, worm castings and mycorrhizae. Natural slow release nitrogen.

VERMONT COMPOST FORT LIGHT COMPOST BASED POTTING SOIL

ITEM	SIZE	PRICE
4354	20 QUARTS	\$15.85
4355	60 QUARTS	\$39.80
4356	2 YARD SLING	\$749.50

Made for organic growers who want a compost-based growing mix. Uses include seed germination, transplanting vegetable and flower starts, and transplanting houseplants.

VERMONT COMPOST FORT VEE ALL PURPOSE COMPOST BASED POTTING MIX

ITEM	SIZE	PRICE
4359	20 QUARTS	\$15.85
4360	60 QUARTS	\$39.80
4361	2 YARD SLING	\$749.50

A compost-based soil with the handling and watering characteristics of a peat-perlite mix. Particularly good for growers using smaller celled flats or hanging baskets. Blended from composted manure and plant materials. Uses include seed germination, transplanting vegetable and flower starts, and transplanting houseplants.

COAST OF MAINE QUODDY-LOBSTER AND CRAB COMPOST

ITEM	SIZE	PRICE
15344	60 CF Sack	\$545.00

A natural and organic compost blend with Lobster and crab. Formulated for vegetables, flowers and lawns. Improves and revitalizes soil.

COAST OF MAINE SPROUT ISLAND BLEND-SEED STARTER

ITEM	SIZE	PRICE
15345	60 CF Sack	\$580.00

An OMRI listed seed starter blend for seed germination and rooting plant cuttings. Enriched with compost, lobster meal, kelp meal, worm castings and mycorrhizae. Natural slow release nitrogen.

COAST OF MAINE SCHOODIC BLEND-COMPOSTED MANURE BLEND

ITEM	SIZE	PRICE
15346	60 CF Sack	\$395.00

An OMRI listed composted manure blend for conditioning beds, gardens and lawns. Enriched with compost.

FREY GROUP

Also available new this year is Frey Group Professional Grower's Mixes! Frey's mixes have a long history of fulfilling the needs of growers large and small. With several standard mixes they have a mix that will fit any growing operation. Mixes are made to order and made to the highest industry standards. From hanging baskets to large nursery stock, they have a mix for you! **See Page 91 for more info**

Plant's Pride

Irrigation and Crop Cover Supplies



Visit www.PlantsPride.com

PUNCH TOOL FOR TUBING



ITEM	DESCRIPTION
14472	Punch Tool for Oval Hose, 0.25"
14473	Punch Tool for Oval Hose, 0.4" & 0.42"
14498	Punch Tool, 0.25"
14474	Punch Tool for Layflat, 15mm
14475	Punch Tool for Layflat, 17mm
14483	Drill Bit, Multi-Size

INSERT HOSE FITTINGS



ITEM	DESCRIPTION
14401	Insert Tee 1/2"
14402	Insert Tee 3/4"
14403	Insert Coupling 1/2"
14404	Insert Coupling 3/4"
14405	Insert End Plug 1/2"
14406	Insert End Plug 3/4"

INJECTORS



ITEM	DESCRIPTION
14458	Fertilizer Injector, 3/4"
14462	Suction Assembly for 3/4" Injector
14459	Fertilizer Injector, 1"
14460	Fertilizer Injector, 1-1/2"
14463	Suction Assembly for 1 & 1-1/2" Injector
14461	Fertilizer Injector, 2"
14464	Suction Assembly for 2" Injector

OTHER SIZES AVAILABLE



MICRO SPRINKLERS

ITEM	DESCRIPTION
14454	Microsprinkler Support Stand Set with 20" Tube
14455	Microsprinkler Support Stand Set, 15-3/4" Tube
14484	Microsprinkler, Hanging, Black Nozzle
14485	Microsprinkler, Hanging, Blue Nozzle
14486	Microsprinkler, Hanging, Green Nozzle
14487	Microsprinkler, Hanging, Red Nozzle
14488	Microsprinkler, Upright, Black Nozzle
14489	Microsprinkler, Upright, Blue Nozzle
14490	Microsprinkler, Upright, Green Nozzle
14491	Microsprinkler, Upright, Red Nozzle

SOFT TUBING/DRIPPERS





ITEM	DESCRIPTION
14471	PVS Soft Tubing, 44mm x 1640'
14452	Barb to Barb Coupling
14494	Spider, One Branch Long Arrow Dripper 20"
14497	Spider, Four Branches Long Arrow Dripper 20"
14495	Spider, Two Branches Bend Arrow Dripper 20"
14496	Spider, Four Branches Bend Arrow Dripper 20"

FILTERS





ITEM	DESCRIPTION	SIZE	MESH	CONFIG
14128	Screen Filter NPT, Male Thread	3/4"	120	Traditional
14391	Disc Filter NPT, Male Thread	3/4"	120	Traditional
14392	Screen Filter NPT, Male Thread	1-1/2"	120	Traditional
14393	Disc Filter NPT, Male Thread	1-1/2"	120	Traditional
14394	Screen Filter NPT, Male Thread	2"	120	Traditional
14395	Disc Filter NPT, Male Thread	2"	120	Traditional
14396	Super Disc Filter NPT, Male Thread	2"	120	Y
14397	Screen Filter NPT, Male Thread	2"	120	Inverted T

AIR VALVES

ITEM	DESCRIPTION	
14450	K Type Kinetic Air Valve, 1" BSP/NPT	
14451	K Type Kinetic Air Valve, 2" BSP/NPT	

FOGGERS

ITEM	DESCRIPTION	
14448	Fogger, 4-Way with Black Nozzle	
14449	Fogger, 4-Way with Grey Nozzle	

GROUND COVER



ITEM	SIZE	OZ/SQ YARD
14346	3'x300'	3.2 oz/sq yd
14347	4'x300'	3.2 oz/sq yd
14348	6'x300'	3.2 oz/sq yd
14349	10-1/2'x300'	3.2 oz/sq yd
14350	12-1/2'x300'	3.2 oz/sq yd
14351	15-1/2'x300'	3.2 oz/sq yd

ROW COVER



ITEM	SIZE	OZ/SQ YARD
14313	7'x500'	0.59
14312	7'x1000'	0.59
14319	10'x500'	0.59
14318	10'x1000'	0.59
14320	14'x1000'	0.59
14321	20'x1000'	0.59
14322	30'x1000'	0.59
14323	40'x1000'	0.59
14324	50'x500'	0.59
14326	7'x500'	1.00
14325	7'x1000'	1.00
14327	10'x500'	1.00
14329	14'x500'	1.00
14328	14'x1000'	1.00
14330	20'x1000'	1.00
14332	50'x820'	1.00
14331	50'x820'	1.50



CAMLOCK-IRRIGATION



SIZE	MALE X FPT	FEMALE X MPT	FEMALE X INSERT	FEMALE X FPT	MALE X INSERT	MALE X MPT	FEMALE CAP	MALE CAP
1-1/2" Aluminum	14414	14415	12575	14417	12574	12625	14437	14438
1-1/2" Poly	12139	14423	14425	14426	14429	14430	14442	14447
2" Aluminum	11826	11971	5018	14418	5019	10814	13156	12432
2" Poly	12025	12019	3831	11825	3832	12020	14445	13227
3" Aluminum	14204	14416	13819	14419	13820	14421	14439	14440
3" Poly	14422	14424	3833	12347	3834	14431	14446	12242

IRRIGATION HOSE



14398
14399, 14400 14432, 14433, 14434 14435, 14436

ITEM	DESCRIPTION	SIZE	PSI
14398	Orchard Tubing	1/2"x1640'	68
14399	Orchard Tubing	3/4"x656'	36
14400	Orchard Tubing	1"x656'	36
14407	Stakes for Tubing	1/2"	
14432	Layflat Hose Blue	1-1/2"x328'	80
14433	Layflat Hose Blue	2"x328'	80
14434	Layflat Hose Blue	3"x328'	70
14435	Layflat Hose Red	2"x328'	150
14436	Layflat Hose Red	3"x328'	150

EZ LOC FITTINGS



ITEM	DESCRIPTION
Fittings fr 1/2" Orchard Tubing & 18MM PC	
14408	Coupling, 600s Loc
14409	Tee, 600s Loc
14411	End Plug with Ring, 600s Loc
14412	0.40" Barb x 600s with Valve
14413	Coupling, 600s Loc with Valve

DRIP TAPE FITTINGS



ITEM	DESCRIPTION
14135	Drip Tape x 0.40" Barb with Valve
14132	Drip Tape x 0.40" Barb
14388	Drip Tape LOC Tee
14389	Drip Tape LOC End Plug with Ring
14390	Drip Tape LOC Coupling with Valve
14134	Drip Tape LOC Coupling

DRIP TAPE



ITEM	DESC	SPCG	MIL	LNPTH	FLW
14385	PC Dripline	12"	18MM	1640'	
14386	PC Dripline	24"	18MM	1640'	
14387	PC Dripline	40"	18MM	1640'	
14136	Drip Tape	8"	8MIL	6561	0.53
14137	Drip Tape	12"	8MIL	6561'	0.53

IRRIGATION

MIXRITE PROPORTIONAL INJECTOR, 11 GPM

This fixed ratio 1:100 offers an alternative to the Chemilizer with similar specifications.

This proportional fertilizer injector automatically compensates for any change in water pressure or flow to provide a constant mix at 1:100 rate. **Standard pump:** fixed ratio 1:100. **Flow Rate:** 10.2 – 660 gph (0.17 – 11 gpm)

Operating Pressure: 6 – 120 psi. **Connections:** 3/4" male thread.

Also available upon request: 22 GPM, 45 GPM and 110 GPM units.

MixRite

Wear part replacement kits in stock.



MR11

Item #	Description	Price
2840	MixRite Unit (Model 556AG), 1:100	\$279.50
13797	Bypass for MixRite, FHT x MHT, this plumbing comes with three valves, filter, and check valve.	\$ 70.00
12694	Cart Unit: Includes MixRite, bypass, 6 gal. tank, and push cart.	\$457.95



MIXRITE TF-5-002 FERTILIZER INJECTOR

ITEM NO.	PRICE
2810	\$550.00

Mixrite TF-5 injectors are positive displacement water driven injectors. No electricity needed. There is constant concentration of additive no matter what pressure and flow. The solution is added in proportion to the water flow for accuracy. The TF models have adjustable injection rates.

TF-5 is a low to medium flow unit used for fertilizers, pesticides and other additives for farming and irrigation. Not intended for strong acids and alkalis or solvents. Flow rates of .88 - 22 GPM. The TF-5 has 1" MPT inlet/outlet connections. Providing higher flow rates, less friction loss and longer life than comparable models.



IRRIGATION

CHEMILIZER PROPORTIONAL INJECTOR, 11 GPM

The big advantage of this unit is that the chemical pump takes all the abuse of the chemicals and is easy to disassemble or replace by hand. Parts are inexpensive, too. The water powered motor is never contaminated by any chemicals and comes with a 2-year warranty. This proportional fertilizer injector automatically compensates for any change in water pressure or flow to provide a constant mix at 1:100 rate.

Max Temperature: 100° F **Standard pump:** fixed ratio 1:100.

Flow Rate: 1.2 – 660 gph (0.02 – 11 gpm) **Operating Pressure:** 3 – 85 psi.

Connections: 3/4" male hose thread.

Item #	Description	Price
4924	Chemilizer Unit (Model CH9000-210), 1:100	\$269.95
12268	Bypass for Chemilizer, FHT x MHT, this plumbing comes with three valves, filter, and check valve.	\$ 79.50
13664	Cart Unit: Includes Chemilizer, bypass, 6 gal. tank, and push cart.	\$449.75



DOSMATIC SUPERDOS PROPORTIONAL INJECTORS

SuperDos operates without electricity to precisely inject liquid concentrates into a water supply line using fluid flow as the power source. SuperDos is designed with a patented internal mixing chamber that promotes homogeneous mixing, while segregating harsh chemicals from critical internal components. These proportional fertilizer injectors automatically compensate for any change in water pressure or flow and provide a constant mix at the rate you set. **Replacement parts in stock. We service in store.**



Item #	Description	Injection Ratios	Flow Rates	Operating PSI	Price
15334	SuperDos 20, 1" MPT	1:40 – 1:500	0.05 – 20 gpm	5 – 100	\$485.00
15335	On/off handle for DSD20	–	–	–	\$ 46.95
12608	SuperDos 30, 1" MPT, On/off handle installed	1:40 – 1:500	0.15 – 30 gpm	5 – 100	\$695.00
15020	SuperDos 45, 1 1/4" MPT, On/off handle installed	1:40 – 1:500	0.50 – 45 gpm	5 – 100	\$969.25

DOSATRON® PROPORTIONAL INJECTORS

Dosatron® has been serving the horticulture industry for over 35 years and has established itself as the industry standard. Durable and reliable, these units come with common wear parts included. These water powered proportional fertilizer injectors automatically compensate for any change in water pressure or flow and provide a constant mix at the rate you set. Ratio is easy to adjust by hand with lock to ensure your setting isn't changed accidentally. Ideal for fertilizers, fungicides, acids and more. Maximum Temperature: 104° F

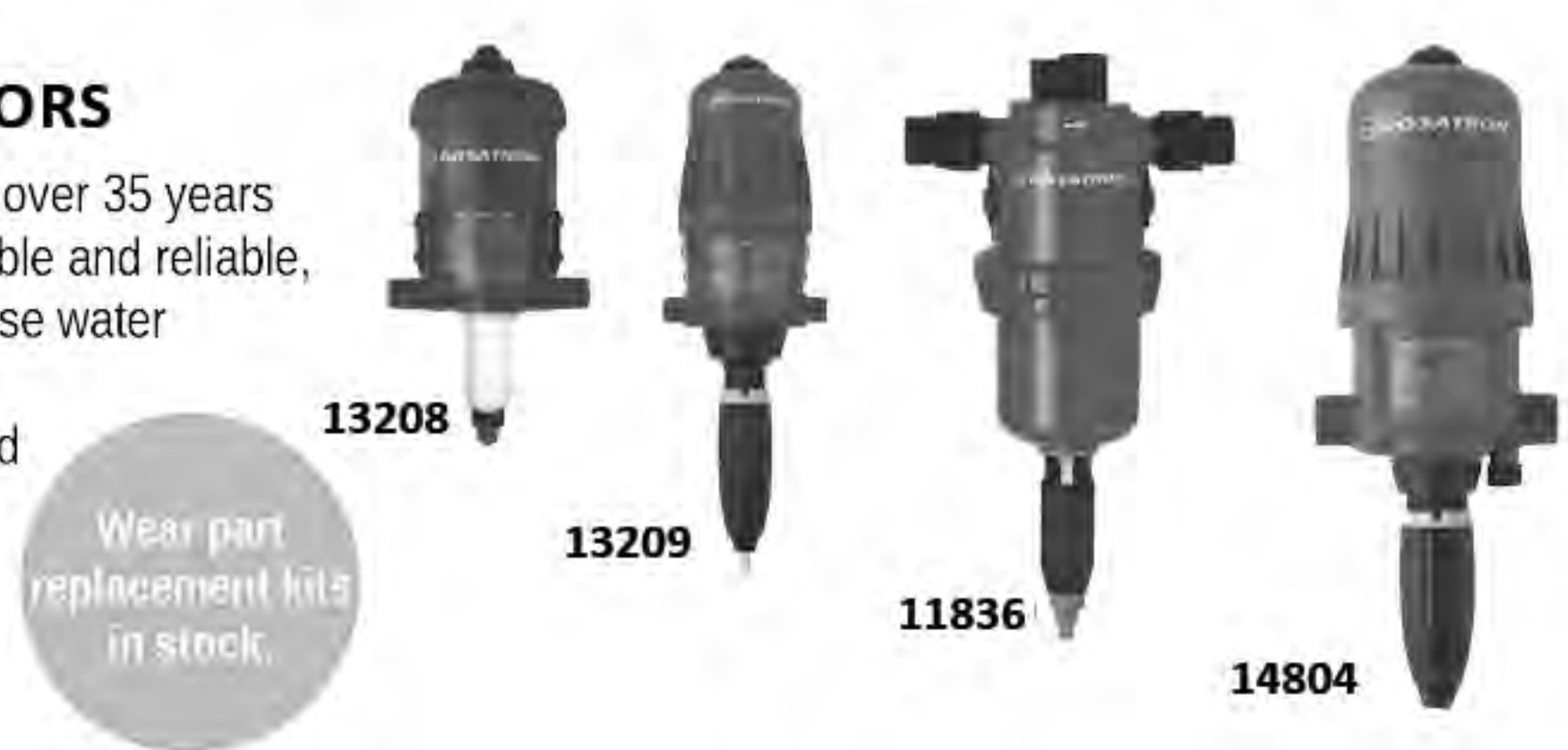

Item #	Description	Injection Ratios	Flow Rates	Operating PSI	Price
13208	D25F1, 3/4" MPT (Our most precise 11 gpm unit)	Fixed 1:100	0.04 – 11 gpm	4.3 – 85	\$345.00
14802	Cart Unit: DOS11, bypass, 6 gal. tank, and push cart.	–	–	–	\$495.65
13209	Dosatron D14M22, 3/4" MPT	1:50 – 1:500	0.04 – 14 gpm	4.3 – 85	\$427.55
14803	Cart Unit: DOS14, bypass, 6 gal. tank, and push cart.	–	–	–	\$529.95
13797	Bypass assembly for DOS11 and DOS14; FHT x MHT includes three valves, filter, and check valve.	–	–	–	\$ 74.95
11836	Dosatron D45RE15, 1" MPT, On/off handle installed	1:66 – 1:500	0.4 – 20 gpm	7 – 70	\$575.00
14804	Dosatron D8RE2, 1 1/2" MPT, On/off handle installed	1:50 – 1:500	2.2 – 40 gpm	2.2 – 116	\$896.75

ORBIT® FAN SPRAY NOZZLE

This fan nozzle features high quality plastic construction. The flow can easily be adjusted with the shut-off valve.



Item #	Description	Price
10207	Orbit® Fan Nozzle with Shut-off	\$4.75

Dramm® Lever Activated Valve

Full flow (up to 11 gpm) squeeze valve with garden hose connections, FHT x MHT.



Item #	Description	Price
10188	Dramm® Lever Activated Valve	\$16.69

MELNOR HEAVY DUTY ALL METAL HOSE REPAIR - 3/4"



ITEM	FITTING	PRICE
3722	Male	\$4.75
3723	Female	\$5.95
3724	Inline	\$6.95

MELNOR METAL HOSE CONNECTORS WITH BUILT IN SHUT OFF VALVES



ITEM NO.	TYPE	PRICE
3725	Two-way	\$7.99

Connect up to 4 hoses to 1 faucet, with a free-spinning coupling nut. Each outlet is individually controlled. Made of solid metal construction and fits standard garden hose threads.

GARDEN HOSE QUICK COUPLERS

These handy quick couplers are designed without a valve for maximum flow and allow water flow when disconnected.



Item #	Description	Price
10186	Brass Female Quick Coupler	\$5.95
10185	Brass Male Quick Coupler	\$2.59

GARDEN HOSE SHUT-OFF ALL STANDARD GARDEN HOSE CONNECTIONS, FHT X MHT

ITEM #	DESCRIPTION	PRICE
10444	LONG HANDLE PLASTIC	\$2.00
13718	SHORT HANDLE PLASTIC	\$2.75
10189	BRASS	\$18.50



IRRIGATION

We have various nozzle, spray valves, and all kinds of IRRIGATION supplies. PLEASE CALL.



LayFlat - Blue

This general purpose blue layflat is a lightweight, tough, and economical water discharge hose great for main supply lines. It will not rot or mildew and coils flat for easy storage.

ITEM	DESCRIPTION	MAX PSI	PRICE	3+ ROLLS
14432	1 1/2" x 328' Blue	80	\$129.95	\$125.95
14433	2" x 328' Blue	80	\$139.95	\$135.95
14434	3" x 328' Blue	70	\$247.95	\$243.95
15328	4" x 300' Blue	70	\$405.75	\$401.75



Blue Stripe® Oval Hose

Blue Stripe® Oval Hose is a lightweight economical tubing made from premium grade polyethylene. Can be punched. Used with insert fittings and clamps.

ITEM	DESCRIPTION	MAX PSI	ROLL WT	PRICE
4670	1" x 660' Oval Hose	42	56 LBS	\$136.95
4891	1 1/2" x 150' Oval Hose	21	16 LBS	\$52.95
3826	1 1/2" x 600' Oval Hose	21	62 LBS	\$153.95
3827	2" x 150' Oval Hose	21	24 LBS	\$62.95
10029	2" x 450' Oval Hose	21	72 LBS	\$156.95
11675	3" x 200' Oval Hose	21	70 LBS	\$175.95



LayFlat - Red

ITEM #	DESCRIPTION	MAX PSI	COLOR	PRICE
15326	1-1/2" X 300'	150	RED	\$324.50
14435	2" X 328'	150	RED	\$431.75
14436	3" X 300'	150	RED	\$710.50
15327	4" X 300'	150	RED	\$1,019.25



Black Poly Pipe

This semi-rigid black utility poly tubing is useful for underground, well, or high pressure applications. Not punchable. Other sizes and PSI ratings available, order 1-2 weeks in advance. CALL FOR PRICING.

ITEM	DESCRIPTION	MAX PSI	PRICE
11473	3/4" x 100'	100	\$27.95
11474	1" x 100'	100	\$33.95
10178	1" x 300'	100	\$95.95



Orchard Tubing

This lightweight polyethylene tubing is punchable and is often used for a lateral distribution & supply hose for on-line drippers, weighted drip tubes, micro sprinklers and can be used as a headline for small drip tape systems.

ITEM	DESCRIPTION	PRICE
14398	3/16" x 11640' Orchard Tubing	\$125.00
11478	1/2" x 100' Orchard Tubing	\$19.75
14399	1/2" x 656' Orchard Tubing	\$70.00
10281	1/2" x 1000' Orchard Tubing	\$89.95
11480	Plastic Stake to secure 1/2" tubing	\$0.25
14398	3/16" x 1640' Orchard Tubing	\$125.00
11481	3/4" x 100' Orchard Tubing	\$22.95
14400	3/4" x 1640' Orchard Tubing	\$125.00
11482	1" x 250' Orchard Tubing	\$63.55



PVC Pipe Schedule 40

ITEM	DESCRIPTION	PRICE
11411	1/2"	\$0.90/ft
4903	3/4"	\$1.05/ft
11412	1"	\$1.49/ft
10342	1 1/2"	\$2.20/ft

ITEM	DESCRIPTION	PRICE
14479	2"	\$2.80/ft
14805	3"	\$5.55/ft
14806	4"	\$2.75/ft

Aqua-Traxx TORO
with the **PBX Advantage**



Plant's Pride

**QUANTITY DISCOUNTS MAY APPLY!
PLEASE CALL**

DRIP IRRIGATION TAPE

NAME	ITEM	FLOW RATE PER 100'	DESCRIPTION	PRICE
12" Spacing				
	10432	.45gpm	15 MIL 4000'	\$181.00
	2985	.38gpm	10 MIL 6000'	\$180.00
	14137	.53gpm	8 MIL 6561'	\$165.95
	10012	.45gpm	6 MIL 10,000'	\$209.00
12" Spacing				
	3925	.34gpm	10 MIL 6000'	\$181.00
	2987	.34gpm	8 MIL 7500'	\$179.00
12" Spacing				
	4956	.22gpm	8 MIL 7500'	\$179.00
	12404	.22gpm	6 MIL 10,000'	\$209.95
8" Spacing				
	14493	.40gpm	8 MIL 6561'	\$165.95
	14136	.53gpm	8 MIL 6561'	\$165.95
6" Spacing				
	14492	.53gpm	8 MIL 7500'	\$182.00
4" Spacing				
	11782	1.34gpm	8 MIL 7500'	\$184.00
16" Spacing				
	12400	.25gpm	8 MIL 7500'	\$181.00
16" Spacing				
	12401	.17gpm	6 MIL 10,000'	\$209.00

AQUA-TRAXX DRIP IRRIGATION TAPE WITH THE PBX ADVANTAGE

NAME	ITEM	SECONDARY #	DESCRIPTION	PRICE
Flow Control .45 GPM/100' 12" Spacing				
	12008	APC08	8 MIL 7500'	\$210.00
	10174	APC10	10 MIL 6000'	\$212.00
Flow Control 0.34 GPM/100' 12" Spacing				
	12405	APC081	8 MIL 7500'	\$210.00
	12058	APC101	10 MIL 6000'	\$212.00
Flow Control 0.22 GPM/100' 12" Spacing				
	15329	APC081222	8 MIL 7500'	\$208.00
Flow Control 0.22 GPM/100' 12" Spacing				
	14809	APC101222	10 MIL 6000'	\$210.00
Flow Control 0.67 GPM/100' 6" Spacing				
	12572	APC080667	8 MIL 7500'	\$209.00

BlueLine® PC Pressure Compensating Dripline TORO
18MM (½") Orchard Tubing with Built-In Emitters

Features a unique, built-in flow regulated emitter, providing a constant discharge over a pressure range of 15-60 PSI. The emitter is inseparably welded to the inside wall of the tubing as it is extruded in the manufacturing process. Emitters are factory installed at pre-determined intervals. This one-piece construction prevents damage and loss of drippers, eliminates hole punching and handling damage, reduces installation costs.

BlueLine™ PC may be hung on a wire, laid on the surface or buried. Typically used in orchards, vineyards, over top of containers/mum pots, nurseries, or buried in fields for subsurface applications. **Stock Flow: 0.53 GPH per emitter.**

Item #	Description	Emitter Spacing	Price
11484	18 MM (½") x 1000'	12" spacing	\$169.00
11485	18 MM (½") x 1000'	18" spacing	\$155.00
11486	18 MM (½") x 1000'	24" spacing	\$140.00
11487	18 MM (½") x 1000'	30" spacing	\$139.00
11488	18 MM (½") x 1000'	36" spacing	\$139.00
11480	Plastic Stake to secure ½" tubing		\$0.25

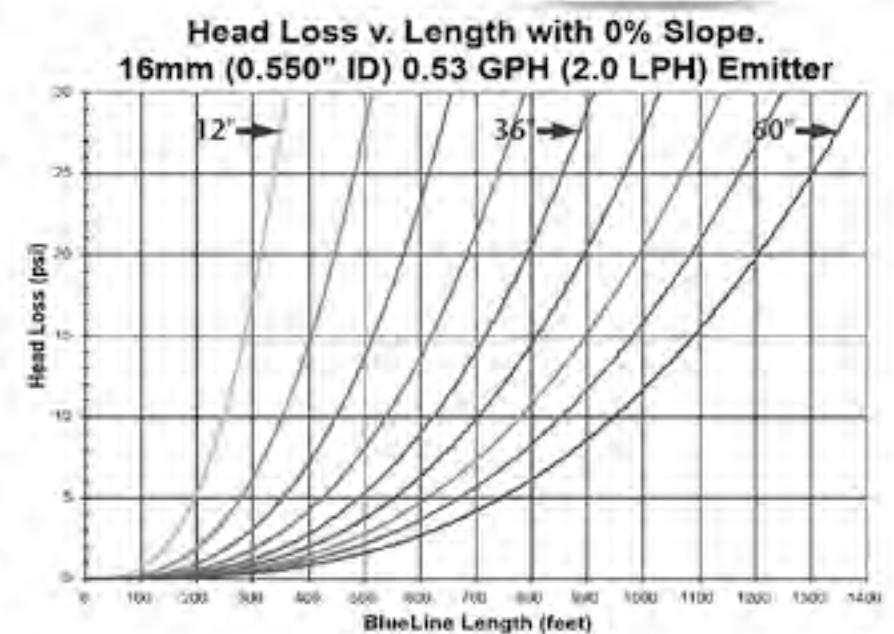

Raised inlets ensure that sediment deposits at the bottom of the tube do not enter the emitter.



Streamlined nature of the emitter encourages debris to pass by rather than enter the inlets.



DRIP TAPE FITTINGS



10822

ITEM.	SECONDARY NO.	DESCRIPTION	PRICE
BARB X TAPE LOC ADAPTER - NO VALVE		QUANTITY DISCOUNT AVAILABLE	
2988	DTF250B	0.25" BARB	\$0.45
14132		0.40" BARB	\$0.45
BARB X TAPE LOC ADAPTER WITH VALVE		QUANTITY DISCOUNT AVAILABLE	
3598	DTF250BV	.25" BARB - BLUE VALVE	\$1.59
14135		.42" BARB - BLUE VALVE	\$1.55
3922	DTF425BV	.425" BARB - YELLOW VALVE	\$1.50
DRIP TAPE END PIECES		QUANTITY DISCOUNT AVAILABLE	
2991	DTFCAP	DRIP TAPE END SLEEVE	\$0.12
14389		TAPE LOC END PLUG WITH RING	\$0.50
TAPE LOC PIECES		QUANTITY DISCOUNT AVAILABLE	
14134		TAPE LOC COUPLING	\$0.50
14390		TAPE LOC COUPLING WITH VALVE	\$1.60
3928	DTFELL	TAPE LOC ELL	\$1.50
12388	DTFFCH	TAPE LOC X AUTOMATIC FLUSH END	\$1.45
3828	DTFFHC	TAPE LOC x LAYFLAT ADAPTER	\$1.00
3830	DTFHEX	INSTALLATION TOOL FOR ITEM 3828 ABOVE	\$6.75
3829	DTFFHCBV	TAPE LOC x LAYFLAT ADAPTER WITH VALVE	\$2.35
2993	DTFFHS	TAPE LOC x FEMALE HOSE SWIVEL	\$1.30
2994	DTFMA	1/2" MPT TAPE LOC x MALE THREAD ADAPTER	\$0.85
2995	DTFMHT	MHT TAPE LOC x MALE THREAD ADAPTER	\$0.75
12402	DTFSSP	TAPE LOC x 1.2" SOC ADAPTER	\$0.95
14388		TAPE LOC TEE	\$1.40
10806	DTF400PIAG	.40" BARB x 1/4" FIPT GAUGE ADAPTER	\$2.10
B709	DTF400PIA	.40" BARB X 1/2" SOC ADAPTER	\$0.80
MISTAKE & GOOF PLUGS		QUANTITY DISCOUNT AVAILABLE	
4376	DTFMP400	Mistake Plugs for .420" holes	\$0.35
5158	OTFMP1	Goof Plugs for 1/8" to 1/4" holes - 10 pack	\$0.55
BARB to BARB COUPLINGS		QUANTITY DISCOUNT AVAILABLE	
10822	TB-250	1/4" Barb to Barb Couplings	\$0.26
14452	TB-450	3/8" Barb to Barb Couplings	\$0.35
PUNCHES FOR OVAL HOSE & TUBING		QUANTITY DISCOUNT AVAILABLE	
3927	DTFACT400	Serrated Insertion Punch for 3989 & 4089	\$32.95
10691	DTFAP02	Ejector Punch: Drippers 1/8" & 3/16" Barbs	\$10.520
10837	DTFAP03	Ejector Punch: COT1, Fittings with .25" Barbs	\$10.75
4961	DTFAP07	Ejector Punch: Fittings with .4/.42/.425 Barbs	\$10.50
10177	DTFDP400S	Red Deluxe Serrated Punch for .4" or .41" Barbs	\$42.95
14474	DTFFHP2	Layflat Punch for tape fittings	\$51.00
14473		Punch Tool, 0.25"	\$10.00

Insert Hose Fitting *Don't See Something? Call!*

Insert Tee

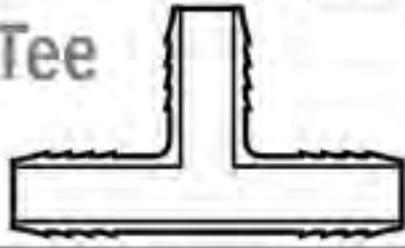

Item #	Size	Price
14401	½"	\$1.75
14402	¾"	\$1.45
11073	1"	\$2.20
11074	1½"	\$3.55
4947	2"	\$6.00

Insert Tee, Reducing

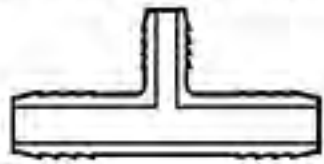

Item #	Size	Price
11083	¾ x ½"	\$2.25
10828	1 x ¾"	\$2.45
11084	1½ x ¾"	\$4.75
11085	1½ x 1"	\$4.70
11086	2 x 1"	\$5.95

Tee, Insert x FPT

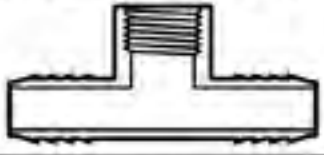

Item #	Size	Price
11100	½"	\$1.95
11101	¾"	\$2.60
11102	1"	\$3.00
11103	1½"	\$6.75
11104	2"	\$7.40

Tee, Insert x FPT, Reducing

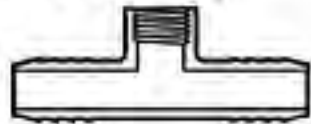

Item #	Size	Price
11124	¾ x ½"	\$2.20
11125	1 x ¾"	\$2.80
4950	1½ x ¾"	\$6.30
11126	1½ x 1"	\$6.30
4949	2 x ¾"	\$6.70
11127	2 x 1"	\$7.20

Tee, Insert x MPT

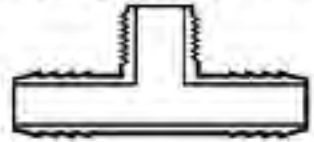

Item #	Size	Price
11119	½"	\$2.50
11120	¾"	\$3.05
11121	1"	\$3.80
11122	1½"	\$5.00
11123	2"	\$6.75

Insert Coupling



Item #	Size	Price
14403	½"	\$0.95
14404	¾"	\$0.99
10682	1"	\$1.45
10812	1½"	\$1.65
10018	2"	\$2.65

Insert Plug

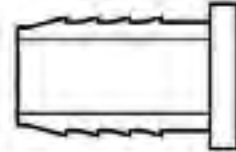

Item #	Size	Price
14405	½"	\$1.45
14406	¾"	\$1.45
4767	1"	\$1.85
11089	1½"	\$2.35
10020	2"	\$4.15

90° Ell, Insert

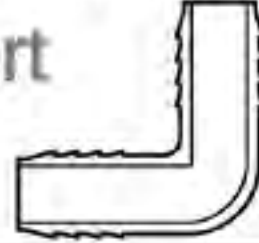

Item #	Size	Price
11105	½"	\$1.70
11106	¾"	\$1.80
11107	1"	\$1.95
11108	1½"	\$2.30
4948	2"	\$3.25

90° Ell, Insert x FPT

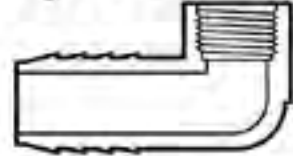

Item #	Size	Price
11109	½"	\$1.85
11110	¾"	\$1.85
11111	1"	\$2.25
11112	1½"	\$3.50
11113	2"	\$5.25

90° Ell, Insert x MPT

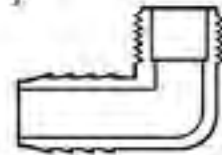

Item #	Size	Price
11114	½"	\$2.10
11115	¾"	\$2.60
11116	1"	\$3.30
11117	1½"	\$5.25
11118	2"	\$7.20

FPT x Insert Adapter

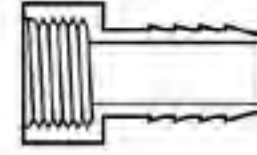

Item #	Size	Price
11077	½"	\$3.60
10833	¾"	\$3.60
10832	1"	\$3.90
11078	1½"	\$5.50
11079	1½"	\$5.59
11080	2"	\$6.50

MPT x Insert Adapter

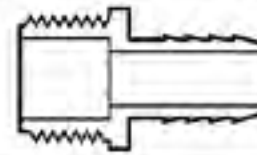

Item #	Size	Price
11090	½"	\$0.95
10835	¾"	\$1.05
10834	1"	\$1.05
11091	1½"	\$1.65
11092	1½"	\$2.85
11093	2"	\$2.85

MPT x Insert Adapter, Reducing

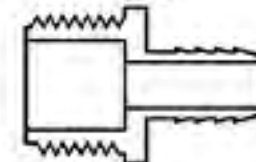

Item #	Size	Price
11128	½ x ¾"	\$2.35
11129	¾ x ½"	\$2.45
11130	¾ x 1"	\$2.65
11131	1 x ¾"	\$2.55
11132	1 x 1½"	\$3.75
11133	1½ x 1"	\$3.45
11134	1½ x 2"	\$4.85
10405	2 x 1½"	\$4.95

SCH80 Nipples, MPT x MPT

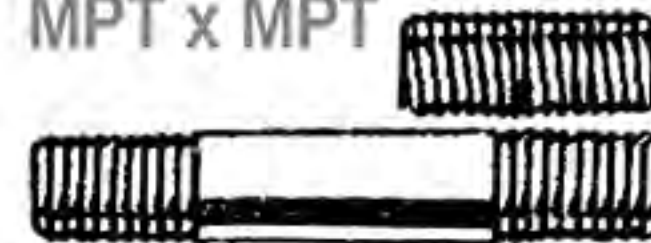

Item #	Size	Price
11135	½" x Close	\$0.85
11136	½" x 3"	\$1.10
4849	¾" x Close	\$0.95
11137	¾" x 6"	\$1.95
11138	1" x Close	\$1.10
14039	1" x 6"	\$2.39
11140	1½" x Close	\$1.75
11141	2" x Close	\$1.99

SS Hose Clamps

All stainless steel — won't rust.



Item #	Size	Ea.	Bag/10
11081	#4	\$0.55	\$5.30
14037	½"	\$0.70	\$6.70
14038	¾"	\$0.75	\$7.20
14036	1"	\$0.75	\$7.20
14035	1½"	\$0.77	\$7.50
10651	2"	\$0.77	\$7.50

PVC Unions

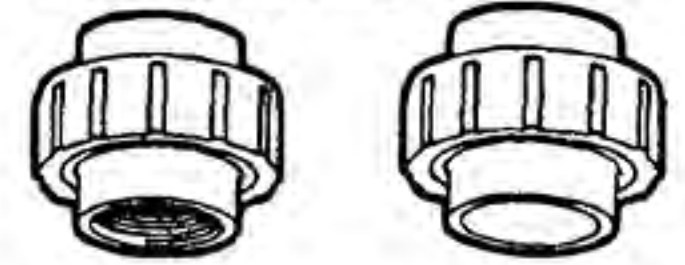

Item #	Size	Price
Threaded:		
11094	½" FPT	\$3.00
11095	¾" FPT	\$4.85
11096	1" FPT	\$5.85
10683	1½" FPT	\$9.65
14813	2" FPT	\$12.95
Socket:		
11097	½" SOC	\$2.50
11098	¾" SOC	\$3.35
11099	1" SOC	\$3.79

Clear Vinyl Tubing

Can be used for replacement suction hose on injectors.

15% Discount on 100' rolls.

Item #	Size	Max PSI	Price Per Ft.
11142	¼"	55	\$0.25
3919	¾"	45	\$0.32

Pressure Gauges

2" Face. ¼" MPT base.



Item #	PSI Range	Price
10805	0-30	\$3.95
11143	0-60	\$3.95
14040	0-100	\$3.95
11144	0-200	\$3.95

Schedule 40 Fittings

Socket Tee

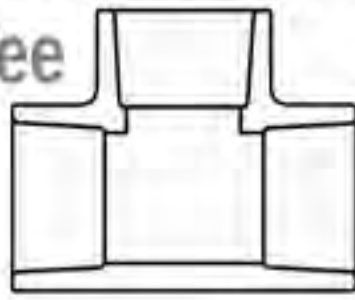

Item #	Size	Price
11354	1/2"	\$0.95
11355	3/4"	\$1.05
11356	1"	\$1.50

FPT Tee

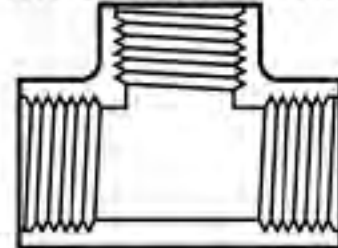

Item #	Size	Price
11357	1/2"	\$3.10
11358	3/4"	\$3.95
11359	1"	\$4.59

Socket Ell



Item #	Size	Price
11360	1/2"	\$0.79
11361	3/4"	\$0.89
11362	1"	\$1.19

Ell, Socket x FPT

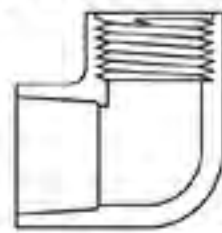

Item #	Size	Price
11363	1/2"	\$0.85
11364	3/4"	\$0.95
11365	1"	\$1.50

FPT Ell

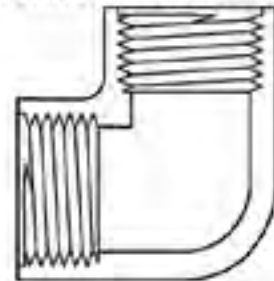

Item #	Size	Price
11366	1/2"	\$1.75
11367	3/4"	\$2.35
11368	1"	\$4.25

Spig x FPT Adp.

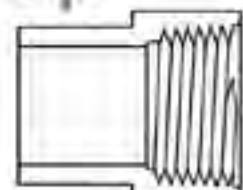

Item #	Size	Price
11369	1/2"	\$0.89
11370	3/4"	\$0.95
11371	1"	\$1.49

Socket Coupling

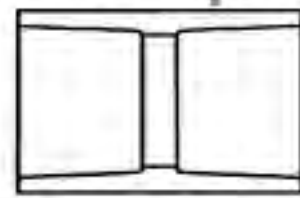

Item #	Size	Price
11372	1/2"	\$0.49
4904	3/4"	\$0.75
11373	1"	\$1.19

FPT Coupling

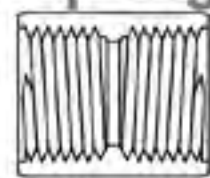

Item #	Size	Price
11374	1/2"	\$0.95
11375	3/4"	\$1.45
11376	1"	\$1.95

FPT x Socket Adp.

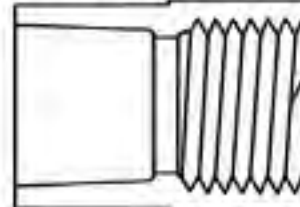

Item #	Size	Price
11377	1/2"	\$0.89
11378	3/4"	\$1.19
11379	1"	\$1.19

MPT x Socket Adp.

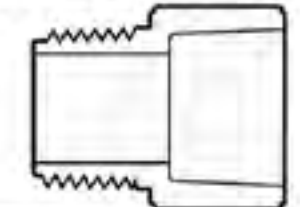

Item #	Size	Price
14597	1/2"	\$0.65
11381	3/4"	\$0.70
11382	1"	\$0.95

MPT x Socket Adp., Reducing

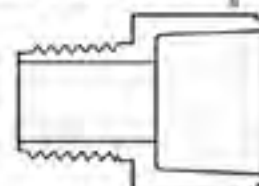

Item #	Size	Price
11383	1/2 x 3/4"	\$1.29
11384	3/4 x 1/2"	\$1.29
11385	3/4 x 1"	\$1.59
4902	1 x 3/4"	\$3.69

Spig x Insert Adp.

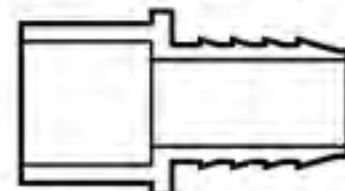

Item #	Size	Price
11386	3/4"	\$2.99
11387	1"	\$2.99

Bushing, Spig x Soc



Item #	Size	Price
11388	3/4 x 1/2"	\$0.69
11389	1 x 1/2"	\$1.19
11390	1 x 3/4"	\$1.19

Bushing, Spig x FPT

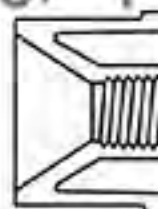

Item #	Size	Price
11392	1/2 x 1/4"	\$1.59
11393	3/4 x 1/4"	\$1.59
4905	3/4 x 1/2"	\$1.59
11394	1 x 1/2"	\$1.59
11395	1 x 3/4"	\$1.59

Bushing, MPT x FPT

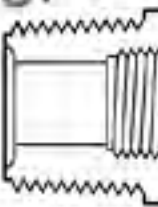

Item #	Size	Price
11396	1/2 x 1/4"	\$3.19
11397	3/4 x 1/4"	\$1.95
11398	3/4 x 1/2"	\$1.95
11399	1 x 1/2"	\$2.39
11400	1 x 3/4"	\$2.35
11401	1 1/4 x 1"	\$2.95
11402	1 1/2 x 3/4"	\$3.85
12609	1 1/2 x 1"	\$3.85
11404	1 1/2 x 1 1/4"	\$3.85
11405	2 x 1"	\$3.95

Socket Cap

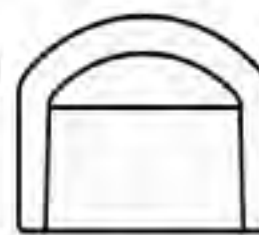

Item #	Size	Price
11406	1/2"	\$0.69
11407	3/4"	\$0.79
11408	1"	\$0.99

ADDITIONAL SIZES AVAILABLE PLEASE CALL

Schedule 40 PVC Pipe



Item #	Size	Price/ft.
11411	1/2"	\$0.90
4903	3/4"	\$1.00
11412	1"	\$1.25

PVC Pipe Cement

Lo-VOC, medium-bodied, clear cement for use on all schedules and classes of PVC pipe and fittings up to 6" diameter.



Item #	Size	Price
10842	1/2 Pint	\$4.75

Teflon Thread Tape

PTFE tape, 3.5 mil thickness.



Item #	Size	Price
11413	1/2" x 520"	Ea. \$0.69 10+\$0.65
11414	1" x 520"	Ea. \$1.39 10+\$1.35

Ratchet PVC Pipe Cutter

Cuts up to 1" PVC pipe.



Item #	Description	Price
PVC45	PVC Cutter	\$16.95

Plastic Pipe & Poly Tubing Cutter

Cuts up to 1" pipe or tubing. Fast, clean cutting.



Item #	Description	Price
11415	Tubing Cutter	\$10.95

**Don't see what you need?
Bet we have it!**
Please Call.

PVC Ball Valves



Item #	Size	Price
Threaded:		
11417	½" FPT	\$1.99
10826	¾" FPT	\$2.69
10827	1" FPT	\$3.95
11418	1¼" FPT	\$4.95
10684	1½" FPT	\$6.75
10817	2" FPT	\$9.45
Socket:		
11419	½" SOC	\$1.99
11420	¾" SOC	\$2.79
11421	1" SOC	\$4.39

PVC Union Ball Valves



Item #	Size	Price
11422	½" SOC	\$7.25
11423	¾" SOC	\$8.75
11424	1" SOC	\$12.50

Brass Ball Valves, FPT



Item #	Size	Price
11425	½" FPT	\$7.00
11426	¾" FPT	\$10.25
11427	1" FPT	\$15.95
11428	1¼" FPT	\$23.95
11429	1½" FPT	\$32.25
11430	2" FPT	\$43.95

Brass Ball Valves, Insert



Item #	Size	Price
11431	¾"	\$24.95
11432	1"	\$27.95
11433	1¼"	\$42.95

**A
D
D
I
T
I
O
N
A
L**

Brass Swing Check Valve

Full flow, FPT x FPT



Item #	Size	Price
11434	½" FPT	\$9.45
11435	¾" FPT	\$9.95
11436	1" FPT	\$13.39
11437	1¼" FPT	\$19.00
11438	1½" FPT	\$26.95
11439	2" FPT	\$37.85

**S
I
Z
E
S**

Brass Boiler Drain Valves

MPT inlet x Male
Garden Hose Thread
outlet.



Item #	Size	Price
11441	¾" MPT Base	\$6.95

**A
V
A
I
L
A
B
L
E**

Frost-Proof Hydrants

High capacity, top-quality
blue hydrants from Boshart
Industries. Bury Depth: 3'.
MHT outlet x FPT inlet (listed
below as size.)



Item #	Size	GPM	Price
11442	¾"	20	\$92.75
11443	1"	28	\$108.00

**P
L
E
A
S
E**

Brass Hydrant Fittings:

Item #	TEE, Insert x MPT	Price
11444	¾"	\$10.95
11445	1"	\$13.95
11446	1" x ¾"	\$12.95

Item #	ELL, Insert x MPT	Price
11448	¾"	\$8.95
11449	1"	\$14.55
11450	1" x ¾"	\$13.75

**C
A
L
L**



IRRIGATION

Battery Operated Controllers



Commercial grade, waterproof, constructed of high impact plastic, these controllers operate on two AA alkaline batteries for up to 3 years. No AC power source required! Fully featured automatic, semi-automatic and manual operation easily programmed with five buttons and easy to read LCD display. Connection: 2 wire.



Single Station with Valve (For specs on valves see listing below.)

Item #	Description	Price
11453	Controller with 3/4" valve	\$100.00
11454	Controller with 1" valve	\$106.95
11456	Controller with 1 1/2" valve	\$164.95
11457	Controller with 2" valve	\$169.75

Multiple Station (Order valves separately below.)

Item #	Description	Price
11458	Four Station Controller with waterproof cables	\$103.95
11459	Six Station Controller with waterproof cables	\$110.75

Battery Operated Valves, 2 Wire DC

Heavy duty plastic valves with DC latching solenoid for the above controllers. They feature a manual flow control valve and are normally closed. Connections are all FPT x FPT. **Operating Pressure: 10 – 150 PSI.**



Item #	Description	Flow Range	Price
11460	3/4" DC Solenoid Valve	0.1 – 28 GPM	\$39.95
11461	1" DC Solenoid Valve	0.2 – 35 GPM	\$42.95
11462	1 1/2" DC Solenoid Valve	20 – 135 GPM	\$93.39
11463	2" DC Solenoid Valve	30 – 160 GPM	\$95.49

Toro® EVOLUTION® AG Series Controller (Use with 24VAC valves)

Introducing a simple, intuitive and economical controller that gives agricultural and horticultural growers the features they need now! The EVOLUTION® AG, built on the award-winning Evolution platform, allows for modular expansion, fertilizer injection, pulse irrigation, **propagation and misting schedules**, along with the freedom to program valves to your specific needs: from 1 second to 24 hours. Full Toro Support for programming questions —please call: 877-345-8676. Features a lockable, weather-resistant case. Can run 3 separate programs. Adjust schedules +/- by percentage. Schedule Options: Weekly, Interval, or Looping. Automatic or manual operation.

Optional accessories (not in stock): Wireless soil sensor, wireless weather sensor, wireless handheld remote, wireless auxiliary relay, Smart Connect® plug-in receiver.



Item #	Description	Price
11464	Four Station Evolution Controller	\$249.95
11465	4 Station Module (to add-to controller)	\$39.95
11466	12 Station Module (to add-to controller)	\$129.95

Indoor 6 Station AC Controllers

Requires 120 volt AC input and has 24 VAC output for valves, has one 9 volt battery for backup and programming. Fully featured automatic, semi-automatic and manual operation easily programmed with four buttons and easy to read LCD display. AC 24 valves sold separately.



Item #	Description	Price
14831	Six Station AC Controller	\$87.95

Electric Solenoid Valves, 24 VAC

These heavy duty plastic valves have manual flow control valve and are normally closed. All connections are FPT. **Operating Pressure: 10 – 150 PSI.**



Item #	Description	Flow Range	Price
10457	3/4" AC Solenoid Valve, 24V	0.1 – 28 GPM	\$24.95
11468	1" AC Solenoid Valve, 24V	0.2 – 35 GPM	\$24.95
11469	1 1/2" AC Solenoid Valve, 24V	20 – 140 GPM	\$82.25
11470	2" AC Solenoid Valve, 24V	30 – 170 GPM	\$91.45

This heavy duty plastic garden hose controller has standard FHT x MHT connections.



Item#	Description	Price
11471	B09D Digital, Max 5.2 GPM & 80 PSI	\$42.95
14832	B0HE-BT Bluetooth, Max 6 GPM & 120 PSI	\$51.95



Mechanical Garden Hose Timer

The Dramm® garden hose timer is simple to use, just turn the dial to desired watering time (up to 2 hours) and the timer will automatically stop the water flow at the time you set. Max flow rate: 5 GPM.



Item #	Description	Price
10808	Mechanical Garden Hose Timer	\$18.95



Fertilizer Injector Units



MIC707

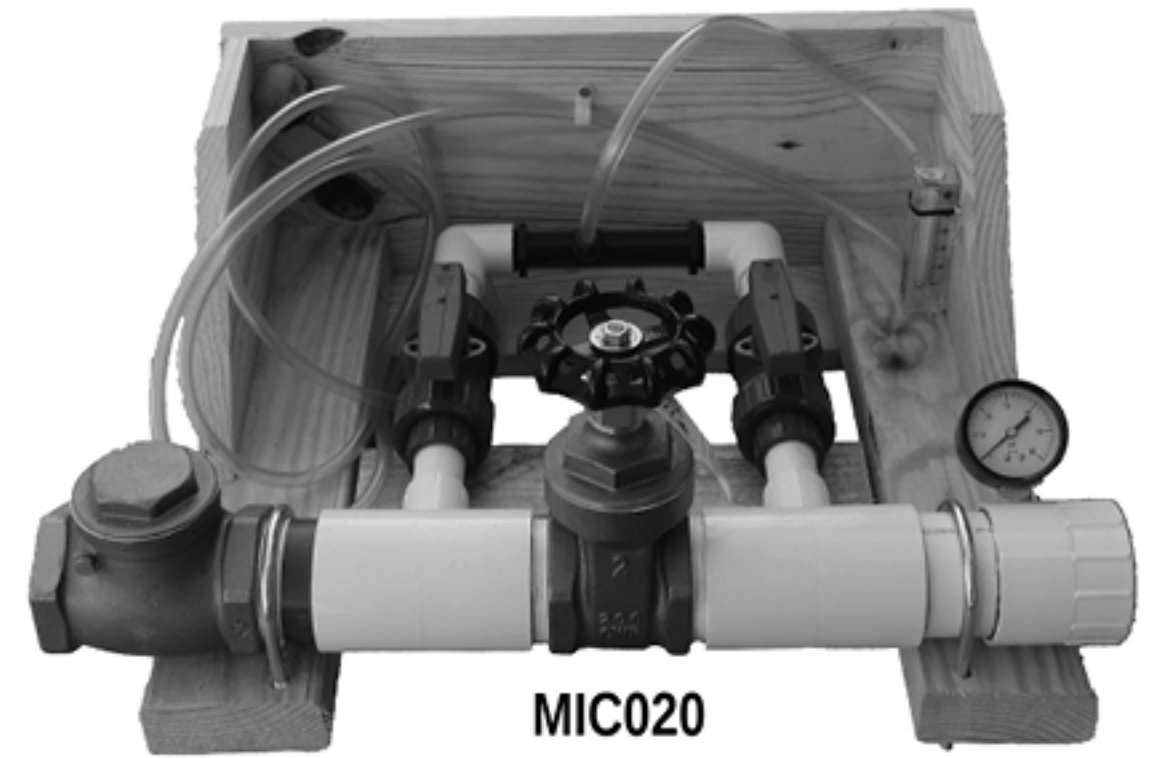

MIC020

TROUBLE FREE INJECTION OF FERTILIZERS

Mazzei injectors are high efficiency, Venturi-type, differential pressure injectors. A pressure difference between the inlet and the outlet of the injector creates a vacuum inside the body, which results in suction through the suction port. The suction can then be used to inject and mix fertilizers and water treatment chemicals into the water. Mazzei injectors are trouble free because there are no moving parts, and have long life because they are molded from chemical resistant polypropylene.

Mazzei non-proportional injectors are excellent for drip systems in fields or high tunnels, provided that fertilizer is based on rate/acre rather than PPM (constant feed). Take lb./Acre per week divided by number of applications for the week and mix it in with approx. 5 gallons of water.

Operating Instructions: Mix and re-mix required fertilizer for irrigation cycle, start irrigation, allow pressure to stabilize in system, open the two PVC bypass valves and slowly close the brass mainline valve until the flow meter rises to the desired injection rate (GPH). Water pressure will drop 3-7 PSI dependent on flow and injection rate. When fertilizer container is empty it will draw air, but that is not harmful. Allow irrigation to operate for a while to ensure fertilizer is all out of the system.

Not Working: Minimum flow rate not met? Clogged? **Check water and fertilizer inlet at injector (black tee).** Liquid fertilizer too heavy? - Dilute with water. Suction leak? Water flow wrong direction? Injector or flow meter installed in bypass backwards?

COMPLETE UNITS (as pictured above)

Injector unit with bypass mainline, 8' suction hose, (GPH) flow meter, back flow check valve, bypass valves, pressure gauge and brass gate valve to control injection rate (normally open).

Item #	Description	Price
10176	Garden hose unit, 3/4" FHT x MHT with Model 384 Injector, no stand	\$148.95
14076	1" FPT with Model 384 Injector, no stand	\$157.95
13632	1 1/2" FPT with Model 584 Injector, with wooden stand	\$205.95
12023	2" FPT with Model 584 Injector, with wooden stand	\$246.95
MIC030	3" FPT with Model 1078 Injector, with wooden stand	\$498.75

INJECTORS ONLY & SUCTION LINE KIT

Item #	Description	Price
14789	1/2" MPT Model 384 Injector Only	\$42.00
12871	3/4" MPT Model 584 Injector Only	\$42.00
MIC1078	1" MPT Model 1078 Injector Only	\$68.00
MIC1583	1 1/2" MPT Model 1583 Injector Only	\$86.00
MIC1	1/4" Suction Line Kit with Flow Meter, for 384 and 584 injectors	\$48.00
MIC183	10 feet 1/2" Suction Line with Strainer and Clamps, for 1078 and 1583 Injectors	\$23.00

REPLACEMENT PARTS

Item #	Description	Price
MICCR2	Check Valve Repair Kit for 384, 484 and 584	\$9.85
MICCR3	Check Valve Repair Kit for Old 878, 978 and 1078	\$9.85
MICCR4	Check Valve Repair Kit for New 1078 and 1583	\$13.85
MICS84	1/4" Suction Strainer, Insert	\$6.95
MICS845	1/2" Suction Strainer, Insert	\$9.95
FLO002	1/4" Tubing Clamp	\$0.60
FLO040	0-40 GPH Flow Meter, 1/4" Insert	\$42.95
FLO100	0-100 GPH Flow Meter, 3/8" FPT	\$49.95

SPECS. CHART

Model	384	584	1078	1583 A
Size	1/2"	3/4"	1"	1 1/2"
Minimum Flow Rates (GPM)	2	6	16	32
Recommended Injection (GPH)	4	8	20	40
Max. Injection (GPH)	10.5	25	75	180
Size Suction Line	1/4"	1/4"	1/2"	1/2"



12871



IRRIGATION



Plastic Spin-Cleaner Filters

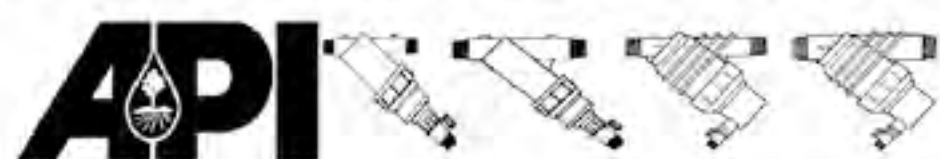

Even well water or other sources of clean water requires filtration for irrigation, especially for permanent or reusable systems. Two-piece threaded housing with O-ring seal for easy maintenance. Strong, stainless steel screens. High Pressure up to 80psi. Ball valve for flushing. Repair parts available. Standard screen: 150 mesh (100 microns).

ITEM	SIZE	MAX FLOW	PRICE
10402	3/4" MPT	9 GPM	\$22.95
10403	1" MPT	18 GPM	\$23.95
10404	1 1/2" MPT	55 GPM	\$195.00
10401	2" MPT	90 PPM	\$218.00

Pressure Regulators

Pre-set, maintain constant pressure and automatically adjusts to flow conditions.

NOTE: If water is shut off or the flow drops below the GPM flowrange, these regulators will not regulate the flow.

ITEM	THREAD	SIZE	PSI	GPM RANGE	PRICE
4845	FHT X MHT	3/4"	15 (GARDEN HOSE)	0.1-8	\$8.95
11451	FPT	3/4"	15	0.5-15	\$9.00
3020	FPT	3/4"	20	0.5-15	\$9.00
13353	FPT	3/4"	35	0.5-15	\$9.00
12617	FPT	1"	15	2-20	\$12.00
10809	FPT	1"	20	2-20	\$12.00
11452	FPT	1"	35	2-20	\$12.00
15330	MPT	1 1/2"	15	7-35	\$35.00
10689	MPT	1 1/2"	20	7-35	\$35.00
10406	MPT	1 1/2"	35	7-35	\$35.00
12586	FPT	2"	15	20-100	\$94.00
15331	FPT	2"	20	20-100	\$94.00
15332	FPT	2"	35	21-105	\$173.75



Plastic Screen Filters

ITEM	DESCRIPTION	SIZE	CONNECTOR CONFIG	MESH STD	PRICE
10417	Plastic Screen Filter (for Gardener)	3/4"	FHTXMHT	155	\$14.00
14128	Plastic Screen Filter	3/4"	NPT(male)	120	\$11.59
14130	Plastic Screen Filter	1"	NPT(male)	120	\$16.85
14392	Plastic Screen Filter	1 1/2"	NPT(male)	120	\$21.85
14397	Plastic Screen Filter	2"	NPT(male)	120	\$88.25
14394	Plastic Screen Filter	2"	NPT(male) T	120	\$88.25
14138	Replacement Screen				\$2.00



Plastic Disk Filter

ITEM	SIZE	CONNECTOR CONFIG	MESH STD	PRICE
14391	3/4"	NPT (male)	120	\$10.50
14393	1 1/2"	NPT (male) T	120	\$21.75
14395	2"	NPT (male) T	120	\$189.95
14396	2"	NPT (male) SUPER Y	120	\$199.95
12576	3"	MPT (male) T	120	\$199.95



Air Valve

ITEM	DESCRIPTION	SIZE	CONNECTOR TYPE	PRICE
14450	Air Valve	1"	BSP/NPT K	\$18.00
14451	Air Valve	2"	BSP/NPT K	\$38.00

TYPICAL DRIP SYSTEM LAYOUT

1. Pump
2. Pressure Relief Valve and/or Switch
4. Check Valve often installed on pump or fertilizer injector
5. Fertilizer Injector, MIC is best choice for most fields.
7. Pressure Gauges often installed on filter or fertilizer injector
8. Screen filter for clean well, Sand Filter for surface water.
10. Mainline, often SDR26 Underground or Layflat
11. Pressure Regulators, pump throttle and/or zone size can be used
12. Gate Valve, not required if using valves on drip tape connectors
13. Submains, Oval Hose or Flatube is best choice.
14. Drip Tape Laterals.
15. Drip Tape Connectors, Numerous types available
16. Drip End Sleeves, Automatic flush valves or knotted.

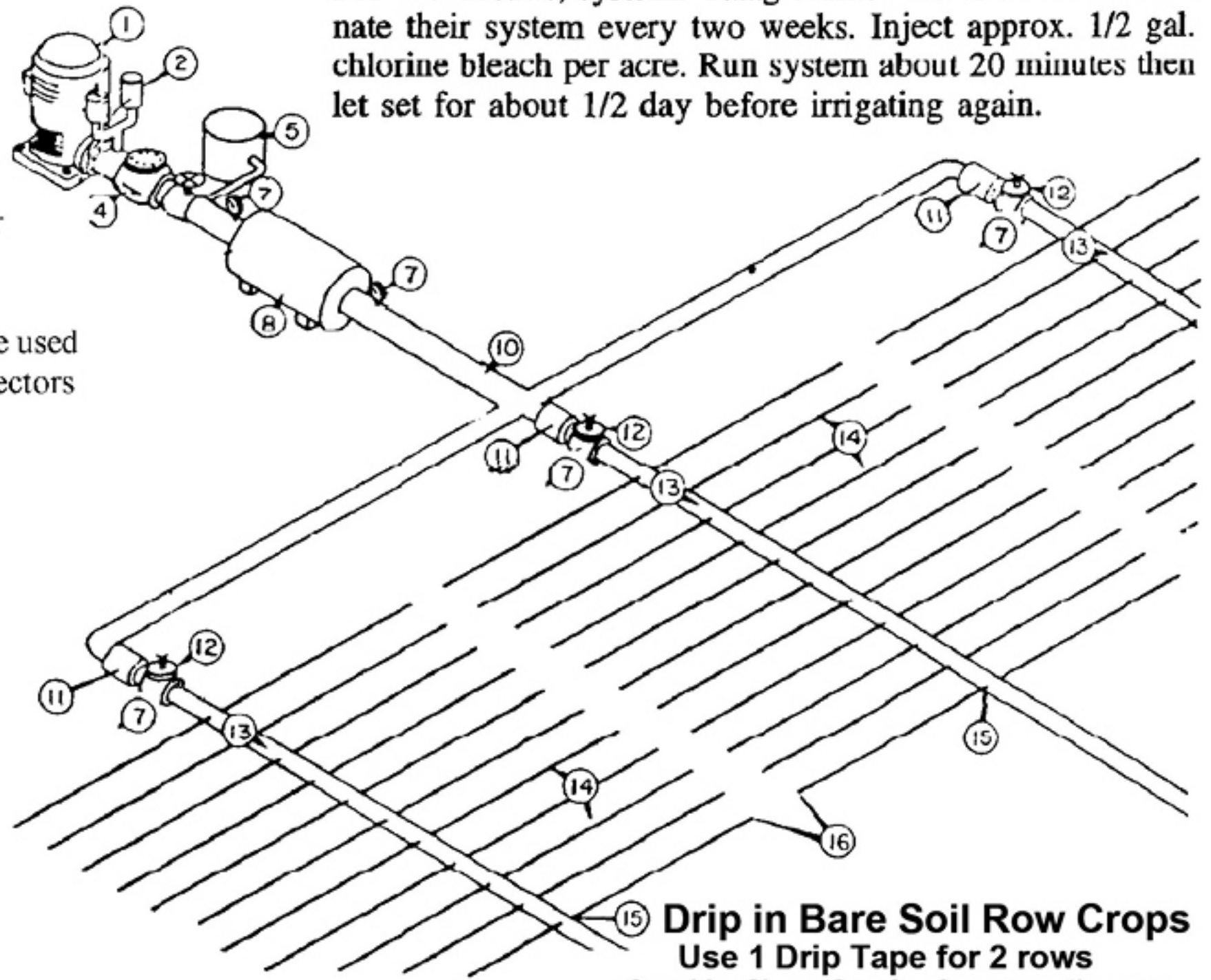

SURFACE WATER CHORINATION

For best results, systems using surface water should chlorinate their system every two weeks. Inject approx. 1/2 gal. chlorine bleach per acre. Run system about 20 minutes then let set for about 1/2 day before irrigating again.

PVC PIPE (SDR-26)

Size	1 1/2"	2"	3"	4"	6"
Flow	PSI	PSI	PSI	PSI	PSI
GPM	Loss	Loss	Loss	Loss	Loss
1	0.00				
2	0.01	0.00			
3	0.02	0.01			
4	0.04	0.01			
5	0.05	0.02			
6	0.08	0.03	0.00		
7	0.10	0.03	0.01		
8	0.13	0.04	0.01		
9	0.16	0.05	0.01		
10	0.20	0.07	0.01		
11	0.23	0.08	0.01		
12	0.28	0.09	0.01	0.00	
14	0.37	0.12	0.02	0.01	
16	0.47	0.16	0.02	0.01	
18	0.58	0.20	0.03	0.01	
20	0.71	0.24	0.04	0.01	
22	0.85	0.29	0.04	0.01	
24	1.00	0.34	0.05	0.02	
26	1.15	0.39	0.06	0.02	
28	1.32	0.45	0.07	0.02	
30	1.50	0.51	0.08	0.02	
35	2.00	0.68	0.10	0.03	0.00
40	2.56	0.86	0.13	0.04	0.01
45	3.19	1.08	0.16	0.05	0.01
50	3.88	1.31	0.20	0.06	0.01
55	4.62	1.56	0.24	0.07	0.01
60	5.43	1.83	0.28	0.08	0.01
65	6.30	2.12	0.32	0.09	0.01
70	7.23	2.44	0.37	0.11	0.02
75	8.21	2.77	0.42	0.12	0.02
80		3.12	0.47	0.14	0.02
85		3.49	0.53	0.16	0.02
90		3.88	0.59	0.17	0.03
95		4.29	0.65	0.19	0.03
100		4.72	0.72	0.21	0.03
110		5.63	0.86	0.25	0.04
120			1.01	0.30	0.05
130			1.17	0.34	0.05
140			1.34	0.39	0.06
150			1.52	0.45	0.07
160			1.71	0.50	0.08
170			1.92	0.56	0.09
180			2.13	0.63	0.10
190			2.36	0.69	0.11
200			2.59	0.76	0.12
225			3.22	0.95	0.14
250			3.91	1.15	0.18
275				1.37	0.21
300				1.61	0.25
325				1.87	0.29

Feet of Row (Drip, Plastic, Etc.) per Acre

Spacing	Lineal Ft.
2'	21,780
2.5'	17,424
2.67'	16,335
3'	14,520
3.5'	12,445
4'	10,890
4.5'	9680
5'	8712
5.5'	7920
6'	7260
6.5'	6700
7'	6222
8'	5445
9'	4840
10'	4356
12'	3630

DRIP TAPE TIPS

Bury it whenever possible especially under plastic so that the plastic layer drag does not damage it. This keeps it from moving around from expansion & contraction. Also minimizes chance of animal or rodent damage. It is also recommended to bury tape with outlets up to avoid potential clogging. Bury tape under plastic 6-8" off center if you plan to plant a single row of crop.

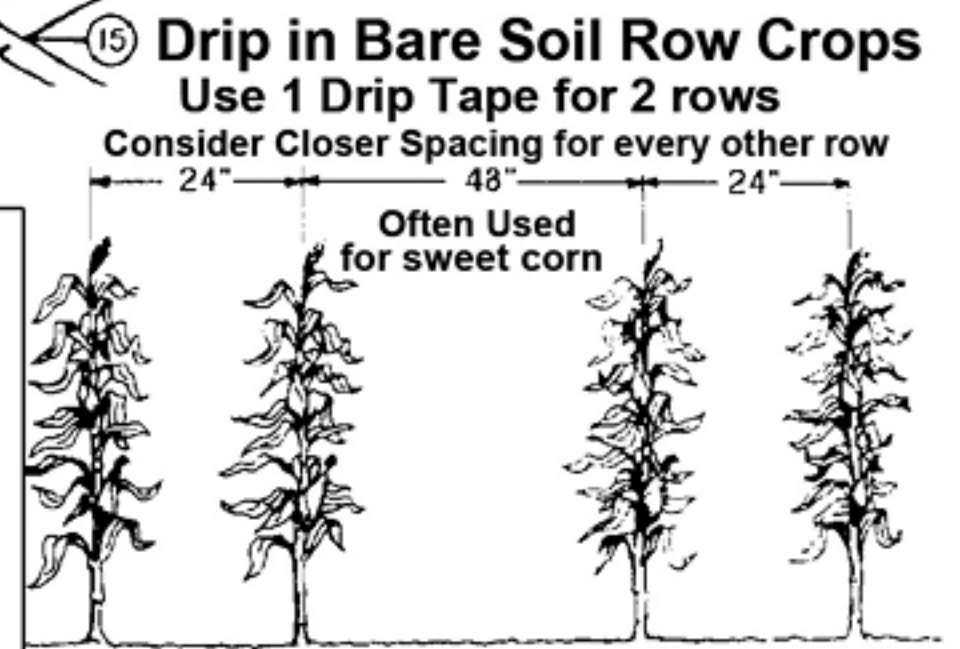

Vinylflow™ Layflat Friction Loss per 100 Ft. (PSI)

GPM	1.5"	2"	2.5"	3"	4"	6"
20	1.2					
30	2.4					
40	5.1	1.1				
50	6.0					
60		2.4	1.4			
80		4.1	1.9	1.0		
90	17.0					
100		6.0	2.8	1.2		
120				1.8		
140				2.2		
160				2.6	0.6	
180				3.3	0.7	
200		2.2	0.7		0.8	
220					1.0	
240					1.1	0.2
250				5		
260					1.3	0.2
280					1.4	0.2
300					1.6	0.2

COMMON FITTING ABBREVIATIONS

RED = Reducing ADP = Adapter
 CLOSE = Short, threads meet in center
FITTING THREAD ABBREVIATIONS
 M = Male thread (On outside of pipe)
 F = Female thread (On inside of fitting)
 P or IP = Standard Pipe
 H = Garden Hose
 T = Thread
 Example: MPT = Male standard pipe thread

PVC FITTING ABBREVIATIONS

Soc or slip = Slides over pipe
 Spig or spigot = Slides inside of fitting
HOSE FITTING ABBREVIATIONS
 Insert or barb = fits inside hose, use clamp
 Small dia. barb can push into hole in hose
 Compression = push over hose, no clamp

Lengths of run in feet at 0% slope

DRIP TAPE	Uniformity	Inlet Pressure (psi)				
		6	8	10	12	15
1.00 gpm	90%	290	292	292	293	294
	85%	370	371	373	373	375
.17 gpm	90%	898	901	904	906	909
	85%	1143	1148	1151	1154	1158
.34 gpm	90%	577	580	581	583	585
	85%	735	738	741	742	745
.45 gpm	90%	483	485	486	487	489
	85%	615	618	620	621	623
.67 gpm	90%	375	376	377	378	380
	85%	477	479	481	482	483



SELF PRIMING PUMPS WITH 6.5 HP GX200 HONDA ENGINE

The model 2P5X is a popular pump in agriculture.
It delivers up to 88 PSI and up to 125 GPM.

Suitable for irrigating up to 2-3 acres at one time. Discharge port rotates in 90° increments.

ITEM	DESCRIPTION	PRICE
11896	MODEL 2P5X - 2" HIGH PRESSURE	\$775.45
13681	MODEL 2P5X - 2" HIGH PRESSURE COMPLETE UNIT WITH ROLL CAGE & 6 GALLON GAS TANK (AS PICTURED)	\$969.75
PU-255H	MODEL 2S5X - 2" TRASH PUMP (UP TO 1" SOLIDS)	\$820.00
PU-355H	MODEL 3S5X - 3" TRASH PUMP (UP TO 1.25" SOLIDS)	\$870.00
IP2P5P	MODEL 2P5PX - 2" HIGH PRESSURE PEDESTAL DRIVE PUMP ONLY WITH 3/4" KEYED SHAFT	\$580.00



Optional Accessories for add-on or can be installed on new units

ITEM	DESCRIPTION	PRICE
IP201	ROLL CAGE (FOR ABOVE PUMPS)	\$92.00
PPA60	6.6 GAL GAS TANK KIT (REMOVABLE QUICK DISCONNECT)	\$95.00
MUR12	MURPHY LOW WATER PRESSURE PUMP SWITCHGAUGE	\$72.00
PPA15	SWITCHGAUGE MOUNTING PANEL AND CONNECTIONS	\$60.00
PPA1180	ENGINE SHUTOFF TIMER, UP TO 6 HRS, HAS BYPASS SWITCH	\$120.00

		2P5X					
GPM		125	100	75	50	25	0
PSI		0 PSI	29 PSI	48 PSI	65 PSI	76 PSI	88 PSI
		2S5X					
GPM		175	125	100	75	50	0
PSI		6 PSI	24 PSI	30 PSI	34 PSI	39 PSI	47 PSI
		3S5X					
GPM		300	200	150	100	50	0
PSI		0 PSI	22 PSI	29 PSI	35 PSI	40 PSI	44 PSI

Ideal for 150' or more elevation (up to 270').
Cast aluminum construction with cast iron diffusers.
High efficiency precision cast aluminum impellers. Self-priming, oil alert. 1-1/2" MPT outlet.



		2S5X					
GPM		175	125	100	75	50	0
PSI		6 PSI	24 PSI	30 PSI	34 PSI	39 PSI	47 PSI
		3S5X					
GPM		300	200	150	100	50	0
PSI		0 PSI	22 PSI	29 PSI	35 PSI	40 PSI	44 PSI

SELECTING A PUMP

- Start with desired operating pressure (i.e. 18 PSI).
- Add 22 PSI per 50' of rise or elevation.
- Add friction loss: see chart on page 88.
- Add filter pressure loss: approximately 7 PSI

Example Total: 65 PSI (operating pressure @ pump).

Frey's Professional Grower Mixes have a long history of fulfilling the needs of growers large and small. With several standard mixes we have a mix that will fit any growing operation. Our peat and bark-based mixes are made to order and made to the highest industry standards. From hanging baskets to large nursery stock we have a mix for you!



Mix 200 – Our Mix 200 has a history of satisfying the rigorous needs of most all annual bedding plants, hanging baskets and seasonal specialty crops. This formula is a lightweight peat-based mix developed for commercial production of greenhouse crops. Appropriate for container sizes down to a 200-cell tray. (pH range 5.8-6.2).

Available in 2.8cf bags, super sacks (60cf) and bulk by the yard.

SKU: M22500
Size: 2.8CF Bag P/40
UPC: 783293005814

SKU: M25000
Size: 60CF Tote
UPC: N/A

MIX 300 - Our most popular mix! A favorite professional mix developed for greenhouse and nursery growers that count on one mix. Mix 300 is a light to medium-weight mix formulated to optimize aeration and moisture retention. Ideal for flowers, vegetables, herbs, and hanging baskets. Appropriate for container sizes down to a 72-cell tray. (pH range 5.2-6.2).

Available in 2.8cf bags, bulk, and super sacks.

SKU: M32500
Size: 2.8CF Bag P/40
UPC: 783293005821

SKU: M35000
Size: 60CF Tote
UPC: N/A

MIX 400 - A mid-weight mix specifically formulated for mums, hemp, bedding plants, daylilies, perennials, and larger outdoor containers 4" and up. Mix 400 has reduced perlite, and a higher bulk density. (pH range 5.2– 6.2).

Available in 2.8cf bags, bulk, and super sacks.

SKU: M42500
Size: 2.8CF Bag P/40
UPC: 783293005838

SKU: M45000
Size: 60CF Tote
UPC: N/A

MIX 500 - A medium to heavyweight mix designed especially for herbaceous and woody perennials. Mix 500 is formulated to improve drainage, maintain porosity, and promote essential aeration. Optimal for container sizes 8" and up. (pH range 5.2 – 6.2). Available in 2.8cf bags, bulk, and super sacks.

SKU: N52500
Size: 2.8CF Bag P/40
UPC: 783293005845

SKU: M55000
Size: 60CF Tote
UPC: N/A

NX-6 - A heavyweight formula different from our other mixes, NX-6 is designed to include 3/4 inch aged bark. The larger bark size breaks down slowly, and increases the porosity for long-term root growth. Ideal for trees, shrubs, native grasses, native plants, and outdoor containers. Perfect for customers preferring a perlite-free mix. (pH range 5.2 - 6.2).

Available in 2cf bags, bulk, and super sacks.

SKU: X62000
Size: 2CF Bag P/50
UPC: 783293005869

SKU: X65000
Size: 60CF Tote
UPC: N/A

CMC STEEL T-POST, GREEN



ITEM	MEASURES	PRICE
12458	1.25 T-POST - 5'	\$7.19
12459	1.25 T-POST - 6'	\$8.95
4818	1.25 T-POST - 6.5'	\$9.95
12460	1.25 T-POST - 7'	\$10.85
4819	1.25 T-POST - 8'	\$12.75
15237	1.33 T-POST	ASK PRICE

Available in lengths of 5 ft. to 8 ft., in 6 inch increments and in weights of 1.25 lb./ft. Finished with a high gloss green enamel. Each post is furnished with 5 wire clips used to fasten the fence or wire to the post. The 10 ft post are 1.33 lb/ft.

**Available to Quote
Pressure Treated
Fence Posts
and
Deer Fencing
Please Call**

FARM SUPPLIES



PICKING BASKETS

The original picking basket. Long term durability. Smooth rounded edges to prevent fruit and vegetable bruising.

13012

Solid Sides 5/8bu available.



5041



	5041	13012
Capacity:	5/8 Bushel	1/2 Bushel
Diameter (OD):	15.5"	14.5"
Height:	13.25"	12.25"
Material:	Polyethylene, UV Stabilized, FDA approved	
Drainage:	Ventilated bottom and sides	
Storage:	Nests for storage	
Weight:	1.76 Lb.	1.16 Lb.

Item #	Description	1-99	100-Skid	Skid Qty
5041	5/8 Bushel Green Basket	\$9.95	\$9.45	496 call
13012	1/2 Bushel Red Basket	\$8.45	\$7.75	696 call

METAL BASKET HANDLE (Pictured on red basket below)

This metal basket handle is designed for both 5/8 or 1/2 bushel baskets. Unique design grabs and releases

Item #	Description	Price
10688	Metal Basket Handle	\$35.39

HD PICKING BASKET

Same size as the 5/8 bu. green basket above, but it is heavier duty and has **no** vents or drain holes. Smooth

Capacity:	5/8 Bushel
Diameter (ID):	13.75"
Height:	13"
Weight:	2.2 Lb.
Storage:	Nests for storage
Drainage:	Solid sides & bottom



Item #	Description	1-99	100+
5021	5/8 Bushel Red Basket	\$10.95	\$10.50

PIK-AID CART

A great back saver. No more dragging along heavy baskets with tomatoes, etc. or having mud collect on bottom of baskets. Carries up to 30 empty 5/8 bu. baskets or 5 gallon buckets. **10" flat-free foam-filled**



Item #	1-2	3+
13633	\$129.95	\$125.95

ALL PURPOSE BASKET, 1.25

This all-purpose basket is the original design durable and dependable.



Capacity:	1.25 Bushel
Weight:	3.5 Lb.
Dimensions:	D 19.1" x H 17"
Storage:	Nests for storage
Drainage:	Ventilated sides & bottom

Item #	Description	1-24	25-Skid	Skid
3803	All Purpose, 1.25 Bushel	\$17.85	\$16.95	CALL
11815	Replacement Handle	\$2.65		

ALL PURPOSE BASKET 1 BUSHEL

- Four handles for easy transfers from one person to the next.

- Handles integrated in the basket allow for tight stacking

(1" stacking height).

- Concave sides for comfortable carrying even when heavily loaded.

- Design allows for tight nesting reducing unused space.

- Flexible polyethylene with

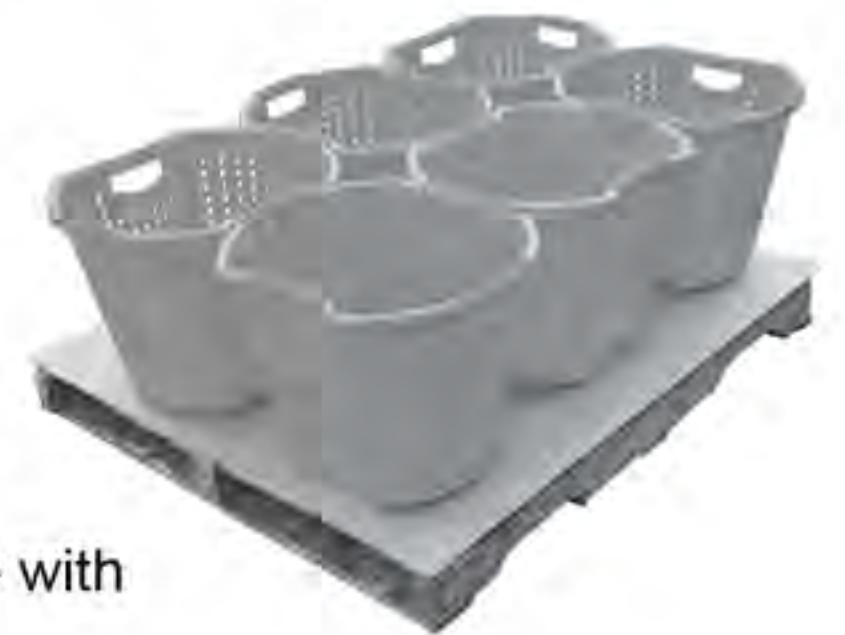

Capacity:	1 Bushel
Dimensions:	L 19.5" x W 16.5" x H 15.5"
Weight:	4 Lb.
Storage:	Nests for storage
Drainage:	Vented sides & bottom

Item #	Description	1-24	25-Skid	Skid 200
10414	All Purpose, 1 Bushel	\$12.85	\$12.75	CALL



General Purpose Container

1.75 Bu.



PC-175

Capacity:	1.75 Bushel (75 to 80 Lb.)
Dimensions (OD):	L 23.5" x W 18.5" x H 12.25"
Material:	Polyethylene, UV Stabilized, FDA approved
Weight:	5.6 Lb.
Storage:	(Half turn) Stack to Nest
Drainage:	Ventilated Bottom and Sides

Item #	Description	1-24	25+
4145	Green 1.75 Bu. Container	\$21.85	\$21.50
12263	Red 1.75 Bu. Container	\$22.85	\$22.50

Utility Box, 1.22 Bushel

Ideal for harvesting, transporting and storing small fruits & vegetables.



3804

11768

Capacity:	1.22 Bushel (40 to 45 Lb.)
Dimensions (OD):	L 19" x W 19" x H 10.5"
Material:	Polyethylene, UV Stabilized, FDA approved
Weight:	5.1 Lb.
Storage:	(Quarter turn) Stack to Nest

Item #	Description	1-24	25+
11768	Blue Box, No Drain Holes	\$18.50	\$17.50
3804	Orange Box, W/Drain Holes	\$18.50	\$17.50

Small Plastic Baskets

Tired of staples in wooden baskets? These baskets are made from UV-treated Polyethylene and stack and unstack with ease. Ideal for harvesting, storing and transporting sweet corn, melons, lettuce and many other fruits and vegetables.



PCL2R

PCL4B

PCL4B

Item #	Description	Color	Dia.	Height	1-49	50+
14833	1/4 Peck (2 Quarts)	Red	6.75"	5.00"	\$3.50	\$3.40
14834	1/2 Peck (4 Quarts)	Beige	8.75"	5.75"	\$4.95	\$4.80
10413	1 Peck (8 Quarts)	Green	11.5"	6.50"	\$6.25	\$6.00

MacroTote 9-FV

This 1/2 bushel tote is a ideal picking container for orchards. 16 fit within the MacroBin 32FV. Smooth rounded corners.



Capacity:	1/2 Bushel	Storage:	(Half turn) Stack to Nest
Weight:	1.9 Lb.	Drainage:	Vented Sides & Bottom
Material:	UV-resistant	Dimensions:	17" L x 11" W x 8.5" H

Item #	Description	1-24	25-Skid
13214	MacroTote 9FV	\$10.40	\$9.95

Harvest Containers



	10632	4667	10411
Color:	Gray	Yellow	Yellow
Capacity:	7/8 Bu.	7/8 Bu.	1-1/8 Bu.
Length:	24"	23.6"	23.8"
Width:	16.13"	15.7"	17.8"
Height:	7.25"	7"	7.6"
Material:	Polyethylene	High-Density Polyethylene	
Drainage:	Ventilated bottom and 2 sides		
Storage:	(Half turn) Stack to Nest		
Weight:	3.1 Lb.	3.25 Lb.	4 Lb.

Item #	Description	1-24	25-Skid
10632	7/8 Bu. Gray Container	\$15.00	\$14.65
4667	7/8 Bu. Yellow Container	\$18.50	\$18.00
10411	1-1/8 Bu. Yellow Container	\$18.75	\$18.25

Wooden Baskets

Soft (woven) bottom. Great for pot covers for mums, etc. Half bushel and bushel basket have two wire handles.



Item #	Description	1-49	50+
10268	1 Peck, 11" Diameter x 7" Tall	\$4.59	\$4.25
2815	1/2 Bushel, 14" Diameter x 9" Tall	\$5.95	\$4.75
2814	Bushel, 17" Diameter x 12 1/4" Tall	\$6.95	\$5.95

Bushel size may not be available this year. Please call if looking.



RUBBER BANDS, ADVANTAGE



Item #	Size	Color	Pcs/Lb.	Typical Use
13199	4½" x 3/16"	Red	280	Cauliflower
4448	4½" x 3/16"	Green	280	Cauliflower
14835	4½" x 3/16"	Yellow	280	Cauliflower
14836	4½" x 3/16"	Blue	280	Cauliflower
10637	3" x ¼"	Red	370	Beets, etc.
4449	2½" x ¼"	Red	425	Asparagus, Broccoli, etc.
4450	3½" x 1/8"	Red	475	All purpose
12545	3" x 1/8"	Red	700	Indian Corn, etc.
10449	2" x 1/8"	Red	1,300	Indian Fingers, etc.
12638	2½ x 1/16"	Red	1,700	Radish, Onions
10634	2 x 1/16"	Red	2,200	Radish, etc.

All bands are sold in 1 Lb. Bags	Price (1-24)	Case (25+)
See above for item # and size.	\$5.25	\$4.65

WINMORE PACKING TAPE

Holds even in coolers.

Item #	Description	1-35	36+
11911	Clear, 2" x 330'	\$2.90	\$2.60
14837	Tan, 2" x 330'	\$2.90	\$2.60



We also carry more supplies!

- Hydro Waxed Clamshell Quarts & Pints
- Red Net Covers
- Carton Staplers

Call for details & pricing.

WAXED VEGETABLE BOXES 15/BDL



ITEM	SIZE	PRICE
13788	1/2 BUSHEL	\$29.85
15339	3/4 BUSHEL	\$49.50
13751	1-1/9 BUSHEL	\$43.95
4353	1 BUSHEL	\$42.95

50LB WAXED CABBAGE BOX



ITEM NO.	PRICE
12316	\$4.90 ea

50LB WAXED CABBAGE BOX. Waxed cardboard cabbage box, holds 50lb of cabbage.

25 LB TOMATO BOX W/O LID



ITEM NO.	PRICE
13247	\$2.21 ea

Made of high density breathable polyethylene. Lid sold separately.

25 LB TOMATO BOX LID



ITEM NO.	PRICE
13872	\$1.00 ea

10 LB, 1 LAYER CARTON



ITEM NO.	PRICE
15045	\$1.75 ea

PUMPKIN BIN, PLAIN



ITEM NO.	PRICE
4166	\$29.00 ea

PUMPKIN BIN - PLAIN NO FLAP - 46 X 37 X 36.
Seasonal items, please order early!

Discounts available for full pallets on boxes.



BERIGARD® MOLDED FIBER BERRY BOXES



Item #	Size	Pcs/Cs	Wt.	1-29	30+
13525	Quarts	297	18 #	\$53.95	\$52.50
11887	Pints	420	18 #	\$48.25	\$45.50
2525	½ Pints	600	21 #	\$65.50	\$63.00

Shippers/Hi-Stackers for Berry Boxes

White cardboard with red print: **Quality Berries** on the quart size and **Farm Fresh Produce** on the pint

Item #		Bundles	Pallet
13772	8 Count Quart Hi-stacker	\$122.65/50bdl	ASK
10416	12 Count 1 Pint shipper	\$99.75/50bdl	ASK
12283	12 Count ½ Pint shipper	\$85.00/50bdl	ASK

ALUMINUM BERRY CARRIER

Holds 8 - 1 Quart Boxes. It features twin carrying handles that fold to the side of the tray

Item #	Description	Price
10415	Aluminum Berry Carrier	\$35.95



WOOD BERRY BOX



ITEM	SIZE	QUANTITY	PRICE
4362	QT	CASE / 500	\$168.75

Unfortunately pint wood berry boxes are unavailable this year.

PT/QT VEX CAPS CASE OF 100



ITEM.	DESCRIPTION	PRICE
4441	100/CASE	\$12.95

Fits 1 pint/quart pulp or wooden baskets.

Call For availability.

Discounts available on full pallets.

APPLE BAGS



ITEM		PRICE
4184	1/2 PECK (500/CS), PLASTIC	CALL
4185	1 PECK (500/CS), PLASTIC	CALL
13871	1/2 BUSHEL (250/CS), PLASTIC	CALL
5102	1/2 PECK (500/CS), PAPER	CALL
13870	1 PECK (500/CS), PAPER	CALL
4186	1/2 BUSHEL (250/CS), PAPER	CALL

1 BUSHEL BULK APPLE BOXES W/DIVIDERS



ITEM.	DESCRIPTION	PRICE
5085	Inner	CALL

Cardboard, 19 5/16" x 12 1/2" x 9 13/16".

ITEM.	DESCRIPTION	PRICE
5086	Outer	CALL

CORN BAGS



ITEM	DESCRIPTION	QTY	PRICE	BALE
3118A	CORN BAG, GREEN MESH, 5dz	EACH	\$0.68	CALL

HAND TOOLS

ITEM	DESCRIPTION	PRICE
14895	Euro-Pro Bypass Pruner 7-3/4", small horticulture pruner with a one-hand locking mechanism	\$21.95
14896	Euro-Pro Bypass Pruner 9", large horticulture pruner with a one-hand locking mechanism	\$21.95
14901	Classic Professional Pruner, 1" cut, 8.5" long. Classic manual pruning shears that is easy to adjust	\$33.95
14902	Bypass Pruner Angled Head Forged 8-1/2". Ergonomical professional pruner. 1" cut	\$33.95
14897	Bypass Pruning Shear Ergo Swiss Style 7". Lightweight and built for smaller hands.	\$12.95
14898	Pruner HD Cut-n-Hold. Perfect for cutting roses and other thorny plants.	\$ 16.95
746	HD Hand Pruner, Classic Cut Bypass Pruner, resharpenable forged steel blade, cuts up to 3/4"	\$ 20.95
10739	Snip, Stainless Steel Long Straight Snip, unobtrusive leather strap lock, 1-3/4" pointed blade	\$10.00
13520	Universal Tool Scabbard, nylon construction, 5" deep pouch fits hand pruners, snips etc.	\$10.00
12889	HD Lopper, Dual Cut Bypass Lopper, fully forged steel construction, 31" handle, cuts up to 2"	\$42.95
14839	Economy Lopper, ComfortGEL Bypass Lopper, non-stick blade, 30" handle, cuts up to 1-1/2"	\$25.00
14905	Sod/Harvest Knife Straight/serrated 3". Great all purpose utility knife.	\$3.95
13766	Small harvesting knife with 7" HD stainless steel blade and textured non-slip handle	\$10.00
14904	Harvest Knife Sheath w/ SS rivets and belt clip; easily fits a 7-3/4" long x 2-1/8" wide knife blade	\$10.95
10438	Large harvesting knife with 12" HD stainless steel blade and textured non-slip handle	\$10.95
13628	Machete, 18" resharpenable tempered steel blade, riveted non-slip handle	\$10.95
15354	Fruit Harvest Bag, steel rimmed. 44lbs picking apron with padded back.	\$55.50

Please see next page for pictures.

FARM SUPPLIES

SHOVELS

ITEM	WEIGHT	PRICE
4595	Round point shovel, 47" wood handle	\$29.69
4592	D-Handle round point shovel, 42.5" overall length, wood handle	\$41.99



RAKES & HOES

ITEM	WEIGHT	PRICE
4598	Poly Leaf Rake, 30" head with 30 tines, 40" fiberglass handle	\$18.99
4724	Aluminum Landscape rake, 30" head, 66" handle	\$77.99
11912	Garden Hoe, 54" fiberglass handle	\$23.99
3377	Onion Hoe, 7" wide forged head, 54" wood handle	\$34.99





HAND TOOLS



14895



14896



14901



14902



14897



14898



746



10739



13520



12889



14839



14905



14839



13766



14904



10438



13628



15354

FARM SUPPLIES





HD TOMATO TRELLIS

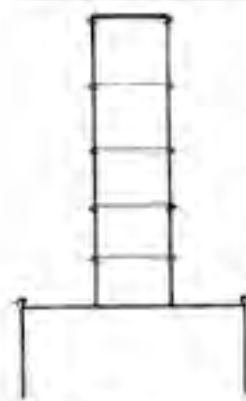

Supports Plants and Row Cover, 3/8" rod frame is 8" wide, 37" high plus 13" long legs and 24" wide at the base. Space 4-5' apart on the row and hook twine into hooks to make trellis. Spaces twine so tomatoes are not jammed between the twine as with regular trellising. Heavy Dupont cover with ropes hemmed into edges simply hooks to bottom hooks on frame. Always install all twine before installing cover.



11750 Trellis \$ 9.45 each
50+ Trellis \$ 8.95 each
200+ Trellis \$ 8.45 each

12247 Cover 82'X 500' \$279.95

TOMATO CAGES

HEAVY-DUTY 36 inch high
Top Ring Dia. 16"
Bottom Ring Dia 13"

11792

1-99 \$ 6.95 each
100-499 \$ 6.65 each
500 & up \$ 6.30 each



Heavy Duty Square Tomato Cage

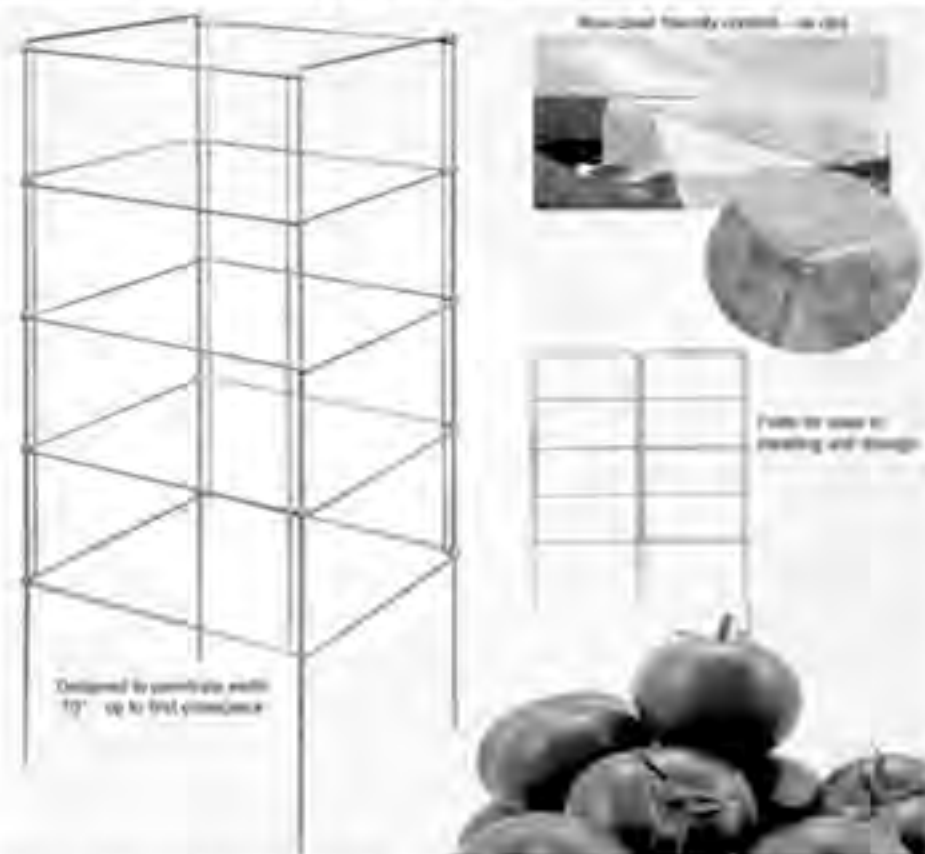

13-1/2" Square, All galvanized steel, spot welded. Top Corners are rounded, excellent for use with row cover. Folds for ease of handling and storage. Double corner posts for greater strength & stability. Designed to go into soil 10", (up to first cross piece).

1-99 100-149 150+

11800 Standard 40" High \$11.85 ea \$10.95 ea \$10.50 ea
10633 Tall 56" High \$15.89 ea \$14.99 ea \$14.55 ea

BLACK VINE CLIPS

These are used when growing tall plants, or vine crops to clip the plant to a string or trellis support wire. They are primarily used by tomato, cucumber and pepper growers. **UV Stabilized.**

4821 Box/1000 \$17.75
11892 Case/10,000 \$115.00

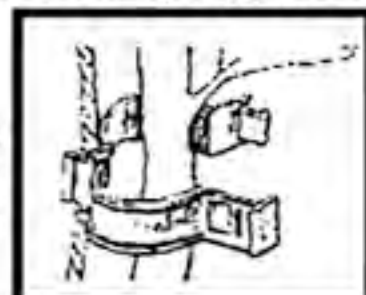

Greenhouse Tomato Trellis

Tired of trying to extend tomato stakes when your plants out grow them? **This is a labor-saving device to trellis greenhouse tomatoes.** Designed with determinate tomato plants in mind, especially grafted plants or varieties that grow to tall for tomato stakes. Will only work with greenhouses that have cross-ties on each arch.

To install: Run a purlin pipe the length of the row (over top of the cross-ties) then hang these trellises between every other plant. Brace first and last trellis (see picture for brace idea). Then install tomato twine as needed to support the growing plants. Installing twine is easy, even once the plants are 5 plus feet tall. Cut as needed to fit structure heights. Taller structures you may need to use short stakes for the first row or two of twine. Hook fits 1-3/8" OD and smaller pipe.



Item #	Description	Price	50+	200+
13742	98" Long, 12 hooks	\$ 8.89	\$ 8.49	\$ 8.14
14208	108" Long, 12 hooks	\$ 9.29	\$ 8.89	\$ 8.54



GREENHOUSE TOMATO TRELLISING HOOKS

For trellising greenhouse tomatoes and cucumbers, etc. Hang on a high wire. Or use S-hooks to hang from pipe. **Twine Hook:** Wire hook releases approximately 7" of twine each time they are turned over, The 11976 includes 30 ft. of UV-resistant white twine prewrapped on the hook and 10 ft. loose, so it can free-fall out of case to speed installation.

Roller Hook: A labor-saving device to lower/lean crops in a smooth, controlled way. Heavy-gauge wire frame supports a spool of twine with 100' of UV-resistant white twine. Easily clips over wire. Concurrently releases twine while sliding down the wire to lower and lean trellised crops.

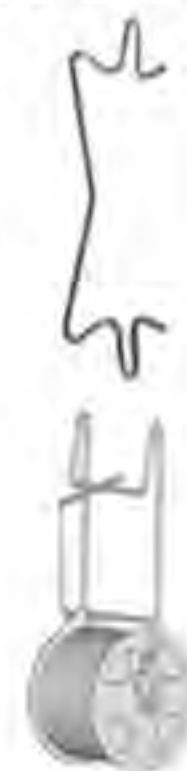

Item #	Description	Each	Pcs/Case
4301	Bare Twine Hook, use HD twine	\$0.16	984/0.12each
14678	Twine Hook loaded W/49'twine	\$0.33	500/0.31 each
11890	Roller Hook Frame (wire part)	\$0.27	550/0.23each
11891	Roller Hook Spool W/100' twine	\$0.47	550/0.41 each
15067	Roller Hook AND Spool 105' twine	\$1.25	240/1.09 each



TREATED TOMATO STAKES

SHARPENED HONDURAS PINE STAKES

Pressure treated rot resistant wood. Sold in packs of 25 pieces.

ITEM	DESCRIPTION	25-SKID	SKID DISCOUNT
3483	1" x 1" x 48"	\$0.95	\$0.92 (1400/SKID)
4939	1" x 1" x 54"	\$1.10	\$1.07 (1400/SKID)
3574	1" x 1" x 60"	\$1.19	\$1.16 (1400/SKID)
3575	1 1/4" x 1 1/4" x 72"	\$2.25	\$2.20 (1050/SKID)
14841	3/4" x 1" x 48"	\$0.79	\$0.76 (1575/SKID)

Untreated White Oak TOMATO STAKES

Sold in packs of 25.

For organic growing. Uniform 1" x 1" square, sharpened.

4938	48"	\$0.89 each	Skid of 1050	\$0.85 each
4661	60"	\$1.10 each	Skid of 1050	\$1.07 each
4898	72"	\$1.29 each	Skid of 1050	\$1.22 each

Untreated Eucalyptus TOMATO STAKES

Sold in packs of 20.

Brazilian Eucalyptus naturally resistant to rot and to mold. Sharpened.

ITEM	DESCRIPTION	20-SKID	SKID DISCOUNT
13770	1 1/4" x 1 1/4" x 72"	\$1.92	\$1.87 (660/SKID)

HEAVY DUTY WINMORE TYING TWINE 6500'



Item	Colors	SIZE	Price
4296	Blue/White	7.5 LBS	\$26.95

Heavy Duty Winmore Tying Twine, 7 1/2 pound ball, good for use in the greenhouse or the field.

TOMATO TWINE 6300'



Item	Price
4298	\$8.30

Quality white twine, box has a belt loop.



CROP COVER



Embossed mulch is our best quality plastic. Embossed mulch does not expand as much when the sun shines on it and therefore it will not flop as much in the wind on a sunny day. It has superior strength for easiest removal.

Call for pricing on 48+ Rolls

EMBOSSSED Black & Clear

This is a reinforced and highly durable embossed mulch which blocks weeds and prevents soil from coming into direct contact with fruit and fresh vegetables.

Reinforced and tough to resist tearing.

Can be laid at higher speeds.

UV Stabilized, designed to last the duration of your growing season.

Stretches very well and hugs tight to the bed.

Works with practically all crop varieties.

SUPER STRENGTH EMBOSSED MULCH

1 mil is equal in strength to most 1.1 mil formula's.

.8 mil is recommended for covering sweet corn.

1.25 & 1.5 mil is for multiple seasons for strawberries, etc.

All Sizes Can Be Shipped UPS			Mil	1-19 Rolls	20+ Rolls
3589	3' x 3000'	Black	1	\$79.00	\$75.00
4379	4' x 2400'	Black	1	\$85.00	\$79.00
4533	4' x 2400'	Black	1.5	\$125.00	\$117.00
2807	4' x 4000'	Black	1	\$135.95	\$129.00
11863	4' x 4000'	Black	1.25	\$168.00	\$160.00
14843	54" x 4000'	Black	1	\$154.95	\$147.00
4580	5' x 2400'	Black	1	\$106.95	\$99.00
3609	5' x 4000'	Black	1	\$165.00	\$161.00
4314	5' x 2400'	Black	1.25	\$126.95	\$121.00
14842	6' x 2400'	Black	1	\$129.95	\$122.00
11864	4' x 4000'	Clear	1	\$139.00	\$134.00
11915	4' x 4000'	Clear	0.8	\$110.00	\$107.00
2920	5' x 4000'	Clear	1	\$172.00	\$168.00
12566	5' x 4000'	Clear	0.8	\$138.00	\$135.00
14844	6' x 2000'	Clear	1	\$110.95	\$108.00

Be sure drip tape is buried in soil, especially under CLEAR Plastic as water droplets can magnify the sun & burn holes in the drip tape.

Micro-EMBOSSED BLACK

Berry

Superior stretchability and hugs tight to the bed. The least expansion in the sun. Recommended for raised beds in sandy soils or windy areas.

			Wt lbs.	1-15 Rolls	16+ Rolls
4941	4' x 4000'	1 Mil	80	\$ 148.00	\$ 144.00
2829	5' x 4000'	1 Mil	100	\$ 185.00	\$ 181.00
14058	4' x 4000'	1.25 Mil	100	\$ 185.00	\$ 181.00

Metalized Aluminum on Black

Reflective metalized color on the top deters insects. The black (bottom) layer stops weed growth.

Heat trap is a 8" wide black strip in center which keeps heat reduction to minimum.

All Sizes Can Be Shipped UPS

			Mil	1-19 Rolls	16+ Rolls
11834	4' x 2400'	With Heat Trap	1.25	\$178.95	\$171.95
4823	4' x 4000'	NO Heat Trap	1	\$229.95	\$220.95
12912	5' x 4000'	NO Heat Trap	1	\$279.95	\$270.00
2834	6' x 2400'	NO Heat Trap	1.25	\$329.95	\$320.00

Embossed WHITE ON BLACK

An ultra reflective top white layer actually decreases the soil temperature to promote growth for heat sensitive crops or warm climates, and provides additional light reflection to the underside off oliage. The black (bottom) layer stops weed growth.

			Wt lbs.	1-15 Rolls	16+ Rolls
12343	3' x 4000'	1 Mil	60	\$138.00	\$135.00
3592	4' x 2400'	1.25 Mil	60	\$138.00	\$135.00
2808	4' x 4000'	1 Mil	80	\$178.00	\$174.00
3800	5' x 4000'	1 Mil	100	\$225.00	\$219.00



Made of Mater-Bi, a starch based material. Novamont produces Mater-Bi with renewable resources such as starches from different non-GMO crops: corn & other cereals, potatoes, & vegetable oils. Mater-Bi complies with international biodegradation and environmental standards such as EN 13432 by Vinçotte and ASTM D6400 by BPI, which guarantee complete biodegradation in soil without any toxic residues. Not OMRI listed.

Degradation rate depends on film thickness, climate, and soil type. Starts breaking approx 4 -5 month on .6mil and 5-6 month on .8mil. Mfg. does not guarantee the film's life span due to different conditions such as non-compliance with laying & usage conditions, climatic conditions, etc.

Lay relatively loose and after a few hours or by the next day, the mulch tightens and clings to the soil bed.

BLACK Bio360

				1-15 Rolls	16+ Rolls
13467	3' x 4000'	.6 mil	Black	\$199.00	\$195.00
10458	4' x 2400'	.6 mil	Black	\$163.00	\$158.00
4530	4' x 4000'	.6 mil	Black	\$265.00	\$259.00 20+
4914	5' x 4000'	.6 mil	Black	\$328.00	\$320.00 20+
11983	4' x 4000'	.8 mil	Black	\$350.00	\$341.00

ECO-ONE Oxo-Degradable

Environmentally sound degradation. Laboratory studies indicate that this degradable plastic breaks down into CO₂, H₂O, and biomass without toxic residues. Degrades fully both above and below soil. Avoid excessive tension when laying and plant immediately after laying. Liability from the manufacture is limited to product defects to the extent of the value of the film. Breakdown period can vary depending on the conditions. This film will break down faster in direct sunlight. We primarily recommend this film for crops where the foliage is casting shade over the film, such as vine crops.

STANDARD LIFESPAN, Starts degrading in 3 - 4 month.

				1-9 Rolls	10+ Rolls
3808	4' x 8000'	.5 Mil	Black	\$319.95	\$311.00

EXTENDED LIFESPAN, Starts degrading in 5 - 6 month

				1-9 Roll	10+ Rolls
E1B648L	4' x 8000'	.6 Mil	Black	\$325.00	\$317.00

BLACK/WHITE SILAGE SHEET



6 MIL Silage sheets made of co-extruded low density polyethylene, UV treated.

Used to cover silage put into the ground, black on one side, white on the other.

ITEM	SIZE	PRICE
4368	24 x 100	\$189.50
4369	32 x 100	\$219.95
4370	32 x 150	\$335.00
4371	40 x 100	\$289.50
4373	50 x 100	\$377.50
4639	50 X 150	\$495.00



Frost Protection Row Cover, 0.59 oz./sq. yd

Standard grade frost protection. Gives frost protection down to 28 degrees F. Great Over winter protection for strawberries, lettuce, spinach, etc.

Item #	Size	Price	4+
14313	7' x 500'	\$64.00	\$62.00
14312	7' x 1000'	\$120.00	\$117.00
14319	10' x 500'	\$88.00	\$85.00
14318	10' x 1000'	\$155.00	\$150.00
14320	14' x 1000'	\$220.00	\$215.00
14321	20' x 1000'	\$390.00	\$385.00
14322	30' x 1000'	\$560.00	\$555.00
14323	40' x 1000'	\$750.00	\$745.00
14324	50' x 500'	\$495.00	\$489.00

Frost Protection Row Cover, 1.0 oz./sq. yd

Item #	Size	Price	4+
14326	7' x 500'	\$119.00	\$115.00
14325	7' x 1000'	\$199.00	\$195.00
14327	10' x 500'	\$170.00	\$165.00
14329	14' x 500'	\$280.00	\$265.00
14328	14' x 1000'	\$595.00	\$580.00
14330	20' x 1000'	\$750.00	\$725.00

Pre-arched Wire Hoops

Heavy duty wire hoops made from 3/16" high-tensile steel wire. Precut and pre-arched. Call for price on full skid of 30 bundles.



Item #	Description	1-9	10+
4660	64" Wire Hoops, 100/bundle	\$73.95	\$71.95
3469	76" Wire Hoops, 100/bundle	\$79.95	\$77.95

Perforated Row Cover

This film keeps a very hot environment in early spring, acting as a mini greenhouse. 3/8" Dia. holes provide a method of venting. 1.1 mil smooth plastic. Note: White is cooler than clear.

Item #	Description	1-9	10+
4534	6' x 2,000' Clear Perforated	\$139.00	\$135.00
14862	6' x 2,000' White Perforated	\$145.00	\$143.00

Typar 518 Row Cover, 1.25 Oz/Sq Yd

We can supply your Typar® needs, but freight will be additional.

A strong, heavy (1.25 oz./sq. yd.) spunbonded polypropylene frost protection fabric. Seams are sewn for strength and durability. Light transmission : 70%. Frost protection: 5-6 +. Superior strength, lasts for 4+ years. An excellent choice for most crops and seasons. Can also be custom ordered any length and width (in 5' increments) required to cover a specific area. All sizes drop ship from Roanoke Rapids, NC. Allow 2 weeks for delivery.

Length	15' wide	30' wide	45' wide	60' wide
50'				
100'				
150'				
200'				
250'				
300'				
350'				
400'				
450'				
500'				

CALL FOR QUOTE

* indicates sizes that can ship UPS Ground. Larger sizes and orders are shipped truck freight.

Shipping cost is additional. (Discounted shipping from factory in Roanoke Rapids, NC.)

5% Discount on orders of \$500 or more. Applies to all sizes over \$500, or multiple pcs. Sizes can be mixed/matched.

Anchor Bags

These anchor bags can be filled with sand, dirt or gravel and used to secure row cover. For plastic bags, use cable ties to close (see page 42).

Woven bags are more puncture resistant.



Item #	Description	Price
4579	12" x 24" 6 mil Black Plastic Anchor Bags, UV treated	250/Case \$105.75
4672	14" x 26" Woven Black Polypropylene Anchor Bags, UV treated, with tie string	100/Pack \$37.95 1000/Case \$330.00

Spring Steel Hoops

Standard spring steel hoop for use with mechanical tunnel layer. Shipping weight: 21 lbs/bundle. Full crate = 5000 pieces.

Item #	Description	1-9	10-49	50+
4897	64" Spring Steel, 100/bdl	\$40.00	\$38.00	\$36.00

ProtekNet™ Insect Netting

Pest and insect control netting for fruits and vegetables. Also protects crops against weather damage. No thermal effect (unlike crop cover).



25 gram 0.35mm x 0.35mm white synthetic fiber.
89% light transmission. Very pliable, great for row crops. Life expectancy: 1-3 years. **Protects against:** Aphids, Armyworm, Brown Stink Bug, Cabbage Root Fly, Carrot Rust Fly, Chrysomelid, Corn Borer, Mite (Not 100%), Flea Beetles, Leafhopper, Leek Moth, Nymph, Onion Maggot, Sawfly, Seedcorn, Spotted Wing Drosophila, Squash Bug, Swede Midge (Not 100%), Tarnished Plant Bug, Thrips (Not 100%).

Item #	Description	Prices	Weight
3591	83" x 328' 25 Gram	\$295.95	14 Lbs.
12013	83" x 820' 25 Gram	\$694.35	30 Lbs.
13608	10' x 820' 25 Gram	\$985.00	43 Lbs.
12509	14' x 328' 25 Gram	\$549.95	26 Lbs.
12599	14' x 820' 25 Gram	\$1393.45	60 Lbs.

47 gram available by quote.

60 gram 1.9mm x 0.95mm. Clear polyethylene.

93% light transmission. Life span 5 yrs. Can be used under greenhouse curtains. **Protects against:** Armyworm, Brown Marmorated Stink Bug, Cabbage Root Fly, Chrysomelid, Corn Borer, Onion Maggot, Sawfly, Seedcorn, Spotted Wing Drosophila (Not 100%), Squash Bug, Tarnished Plant Bug.

Item #	Description	Prices	Weight
4098	83" x 328' 60 Gram	\$337.45	32
10639	14' x 328' 60 Gram	\$627.65	64

47gram is now available: Life expectancy 8-10 years and it will control the Flea Beetles & Swede Midge. However not Thrips or Aphids like the 25gram will, but more durable. **Call for pricing.**

Bird Control Netting

This bird control netting is ideal for crop protection against birds on berries & fruit trees. Flexible high density with 3/4" diamond pattern and 5 year life span.



Green Polyethylene			White Polyethylene		
Item #	Size	Price	Item #	Size	Price
3802	16' x 98'	\$122.95	12254	21' x 328'	\$330.00
3835	32' x 49'	\$122.95	14849	33' x 328'	\$520.00
11803	32' x 98'	\$229.95	13521	49' x 328'	\$750.00

Bird Scare Balloons

Elevate at least two feet above your crop and rotate colors for best results.



Description	Prices
Yellow, Black or White	\$7.95 each

Bird Scare Tape

Deters birds with flashy appearance and noisy crackle.



Item #	Description	Price	5+
12001	Bird Scare Tape, 1 1/4" x 290' Roll	\$8.00	\$7.59
15214	Bird Scare Tape, 3/4" x 100' Holographic	\$8.49	\$7.45

**WE ARE A PROUD DEALER OF
NOLT'S PRODUCE AND
GREENHOUSE SUPPLY.**



Black Woven Ground Cover

This UV stabilized, woven cloth is extremely strong and far superior to sheet plastic. This woven polypropylene fabric that is permeable to air and water, yet blocks weeds effectively. **3.2 - 3.3 oz./sq. yd. with stripes every foot.**

Item #	Size	1-5	6+	Weight
14346	3' x 300'	\$48.95	\$46.00	25 lbs.
14347	4' x 300'	\$64.95	\$62.00	33 lbs.
1348	6' x 300'	\$95.95	\$93.00	50 lbs.
13750	8' x 300'	\$129.70	\$127.00	25 lbs.
14349	10.5' x 300'	\$158.95	\$156.00	87 lbs.
14350	12.5' x 300'	\$195.95	\$193.00	104 lbs.
14351	15.5' x 300'	\$239.95	\$237.00	130 lbs.

White Woven Ground Cover

Same as the black ground cover above except the fabric is white with black stripes every foot. **3.2 oz./sq. yd.**

Item #	Size	Price	Weight
11314	3' x 300'	\$62.95	25 Lbs.
11315	6' x 300'	\$118.95	50 Lbs.

Limited quantities

Steel Sod Staples

Description	Price	+5
10293 HD Staples, 6"x1", 11 gauge, 500/box	\$42.95	\$41.95
3640 HD Staples, 8"x1", 8 gauge, 500/box	\$49.95	\$48.50

UltraWeb Black Woven Ground Cover

Popular as a weed barrier between rows of plastic mulch. Same as the black ground cover except lighter weight at **2.2 oz./sq. yd. with stripes every foot.**

Item #	Size	1 to 3	4+	Weight
11973	3' x 1200'	\$136.95	\$134.00	66 lbs.
12073	4' x 900'	\$136.95	\$134.00	66 lbs.
14852	24' x 200'	\$189.95	\$187.00	89 lbs.
11656	32' x 150'	\$189.95	\$187.00	89 lbs.
14284	40' x 120'	\$189.95	\$187.00	89 lbs.

White on Black Woven Ground Cover

3.8 oz./sq. Yd. Turn white up to reflect the sun and heat.

For applications where cooler soil & sunlight reflection is preferred. Very similar to our black woven ground cover, except stronger, and this product has white and black strands interwoven. Mostly white on one side and mostly black on the opposite side.

The black Underside is a effective weed blocker & prevents weed seed from germinating unlike the all white product we used to handle.

Upon request, we can still get 3.2 oz. white.

Item #	Size	1-5	6+	Weight
14071	3' x 300'	\$69.95	\$67.00	30 lbs.
14850	4' x 300'	\$121.95	\$119.00	40 lbs.
14072	6' x 300'	\$134.95	\$132.00	60 lbs.
14073	12' x 300'	\$269.75	\$267.00	120 lbs.
14074	15' x 300'	\$329.85	\$327.00	150 lbs.

CROP COVER



2024 PRE-ORDER GUIDE

Please keep in mind some items should be ordered early to insure you get them in a timely manner. Also some of these items are in short supply or can only be brought in once or twice a year. So please review the following list and consider placing your order today.

- Growing Mediums, August - September
- Drip Tape - December
- Silage Sheets - September
- Rain Flo Equipment, allow 10-12 week lead time
- Green House Items - December
- Custom Fertilizer Blends, allow 4-6 week lead time
- Onions, Seed Potatoes, Sweet Potato Slips - January
- Garlic - August



ORGANIC FERTILIZERS

www.krehereggs.com

8-2-2 Blend
7-2-6 Blend
4-3-10 Blend
5-4-3 OMRI Listed

OUR PRODUCTS

- We proudly offer a variety of dry granular fertilizers, produced from composted layer poultry manure. Our products are approved for organic crop production.
 - Perform well from start to finish
 - Heat treated to NOP standards
 - Are easy to apply
 - Provide slow nutrient release
 - Enriches and conditions for improved soil health
 - Non-burning when applied properly
- Available in bulk, totes and bags

Progressive Grower
is a valued supplier of
Kreher's Fertilizers
See page 20 for pricing.

Scan To Learn More





Competitively Supplying All of Your Growing Needs

**PO Box 278 • West Wareham, MA 02576
(508) 273-7358
www.ProgressiveGrower.com**

**Shop online and pay bills at
www.ProgressiveGrower.com**

Visit one of our locations

Progressive Grower – Wareham
81 Charlotte Furnace Road
West Wareham, MA 02576
(508) 273-7358

Progressive Grower – Riverhead
1129 Cross River Drive
Riverhead, NY 11901
(631) 591-3540

Progressive Grower – Islandia
100 Patco Ct
Islandia, NY 11749
(631) 778-6577

For general questions, please email us
at Info@ProgressiveGrower.com



High Nitrogen Organic Fertilizer



Visit naturesafe.com
to view our full line of
Ag and Turf products

**Nature
Safe[®]**
FERTILIZERS

A Darling Ingredients Brand

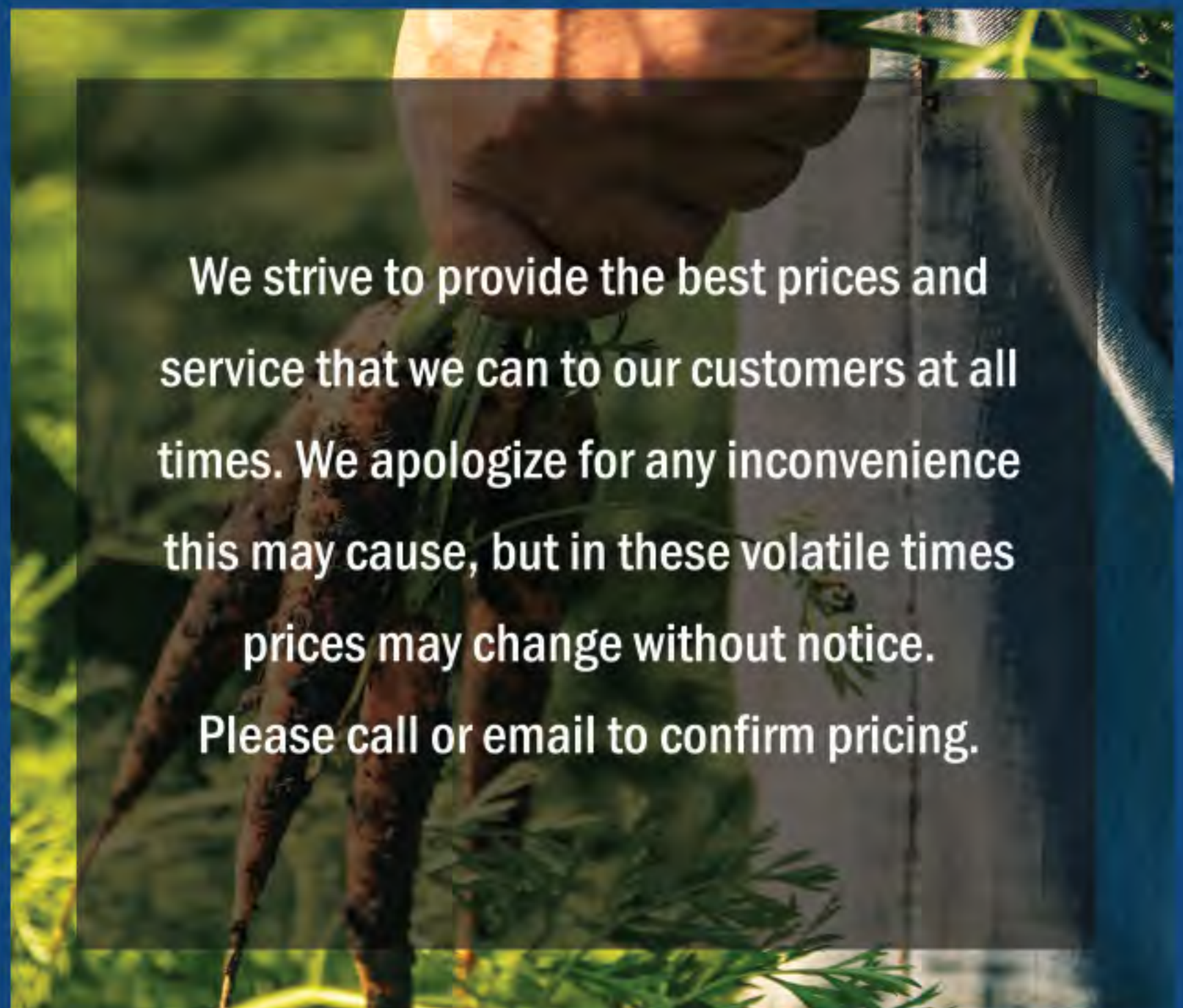

We strive to provide the best prices and service that we can to our customers at all times. We apologize for any inconvenience this may cause, but in these volatile times prices may change without notice. Please call or email to confirm pricing.

Restricted pesticides are available only with proof of proper applicator license.